



US00D779065S

(12) **United States Design Patent**
Brotman et al.

(10) **Patent No.:** **US D779,065 S**

(45) **Date of Patent:** **** Feb. 14, 2017**

(54) **ANTERIOR CERVICAL BONE PLATE**

FOREIGN PATENT DOCUMENTS

(71) Applicant: **NuVasive, Inc.**, San Diego, CA (US)

AU 201121861 A1 9/2011
CN 2477152 Y 2/2002

(Continued)

(72) Inventors: **Michael Brotman**, San Diego, CA (US); **Andrew Wolf**, San Diego, CA (US); **Paul D. Sawin**, Winter Park, FL (US)

Primary Examiner — Charles Hanson
(74) *Attorney, Agent, or Firm* — Jeremy A. Smith; Bradley Arant Boult Cummings LLP

(73) Assignee: **NuVasive, Inc.**, San Diego, CA (US)

(57) **CLAIM**

The ornamental design for an anterior cervical bone plate, substantially as shown and described.

(**) Term: **14 Years**

DESCRIPTION

(21) Appl. No.: **29/504,658**

(22) Filed: **Oct. 8, 2014**

(51) **LOC (10) Cl.** **24-02**

(52) **U.S. Cl.**

USPC **D24/155**

(58) **Field of Classification Search**

USPC D24/155–157

CPC A61B 17/8061; A61B 17/7059; A61B 17/8052; A61B 17/8605; A61B 17/8085; A61B 17/809; A61B 17/8014; A61B 17/8033; A61B 17/8004; A61B 17/888; A61B 17/842; A61B 17/8023; A61B 17/8009; A61B 17/86; A61B 17/1739; A61B 17/8066; A61B 17/1671; A61B 17/1757; A61B 17/8071; A61B 17/176; A61B 2017/1782; A61B 2017/1775

See application file for complete search history.

FIG. 1 is a perspective view of an anterior bone plate showing our new design;
FIG. 2 is a first side view thereof;
FIG. 3 is a first end view thereof;
FIG. 4 is a top view thereof;
FIG. 5 is a bottom view thereof;
FIG. 6 is a perspective view of a second embodiment of an anterior cervical bone plate;
FIG. 7 is a first side view thereof;
FIG. 8 is a first end view thereof;
FIG. 9 is a top view thereof;
FIG. 10 is a bottom view thereof;
FIG. 11 is a perspective view of a third embodiment of an anterior cervical bone plate;
FIG. 12 is a first side view thereof;
FIG. 13 is a first end view thereof;
FIG. 14 is a top view thereof;
FIG. 15 is a bottom view thereof;
FIG. 16 is a perspective view of a fourth embodiment of an anterior cervical bone plate;
FIG. 17 is a first side view thereof;
FIG. 18 is a first end view thereof;
FIG. 19 is a top view thereof; and,
FIG. 20 is a bottom view thereof.

The broken line showing is included for the purpose of illustrating environment and forms no part of the claimed design.

(56) **References Cited**

U.S. PATENT DOCUMENTS

4,488,543 A 12/1984 Tornier
4,794,918 A 1/1989 Wolter

(Continued)

1 Claim, 12 Drawing Sheets

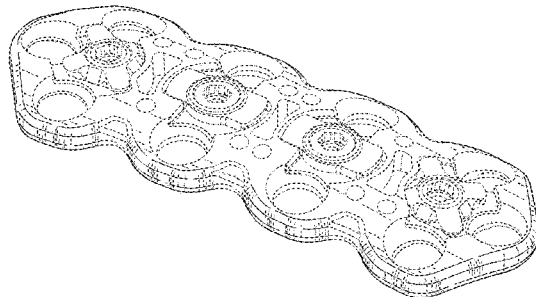
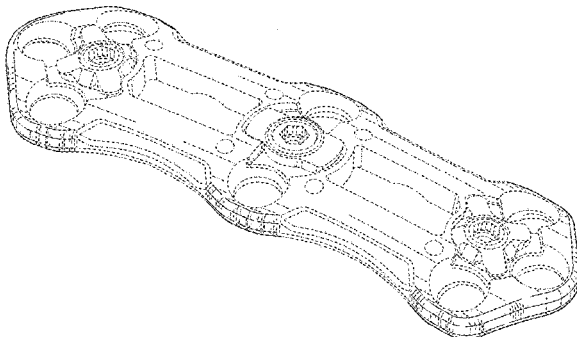

US D779,065 S

(56)

References Cited

U.S. PATENT DOCUMENTS

5,127,914	A	7/1992	Calderale	D615,652	S *	5/2010	Weiman	D24/155
5,364,399	A	11/1994	Lowery	7,727,266	B2	6/2010	Lindemann	
5,380,324	A	1/1995	Muller	7,740,630	B2	6/2010	Michelson	
5,527,311	A	6/1996	Procter	D622,853	S	8/2010	Raven, III	
5,601,553	A	2/1997	Trebing	7,771,458	B2	8/2010	Biedermann	
5,647,872	A	7/1997	Gilbert	D623,744	S	9/2010	Strnad	
5,681,311	A	10/1997	Foley	D623,751	S *	9/2010	Weiman	D24/155
5,735,853	A	4/1998	Olerud	7,857,839	B2	12/2010	Duong	
5,766,254	A	6/1998	Gelbard	D630,750	S	1/2011	Graham	
5,951,558	A	9/1999	Fiz	7,862,597	B2	1/2011	Gause	
6,136,002	A	10/2000	Shih	7,875,062	B2	1/2011	Lindemann	
6,193,721	B1	2/2001	Michelson	7,883,510	B2	2/2011	Kim	
6,206,883	B1	3/2001	Tunc	7,905,830	B2	3/2011	Stefanchik	
D440,311	S	4/2001	Michelson	7,909,860	B2	3/2011	Rathbun	
6,235,034	B1	5/2001	Bray	7,914,561	B2	3/2011	Konieczynski	
D449,692	S	10/2001	Michelson	7,963,980	B1	6/2011	Freeman	
6,336,930	B1	1/2002	Stalcup	7,963,981	B2	6/2011	Binder	
6,406,478	B1	6/2002	Kuo	D643,927	S *	8/2011	Prasad	D24/155
6,413,259	B1	7/2002	Lyons	7,998,180	B2	8/2011	Erickson	
6,423,069	B1	7/2002	Sellers	8,029,551	B2	10/2011	Running	
6,488,685	B1	12/2002	Manderson	8,052,729	B2	11/2011	Dube	
6,503,250	B2	1/2003	Paul	8,057,521	B2	11/2011	Smisson, III	
6,506,191	B1	1/2003	Joos	8,062,296	B2	11/2011	Orbay	
6,558,423	B1	5/2003	Michelson	8,066,750	B2	11/2011	Oi	
6,623,486	B1	9/2003	Weaver	8,109,934	B2	2/2012	Guenther	
6,669,700	B1	12/2003	Farris	8,114,081	B2	2/2012	Kohut	
6,730,127	B2	5/2004	Michelson	8,162,950	B2	4/2012	Digester	
6,740,088	B1	5/2004	Kozak	8,167,918	B2	5/2012	Strnad	
6,793,658	B2	9/2004	LeHuec	8,216,312	B2	7/2012	Gray	
6,866,665	B2	3/2005	Orbay	8,257,408	B2	9/2012	Johnson	
6,872,210	B2	3/2005	Hearn	8,273,111	B2	9/2012	Amato	
6,890,335	B2	5/2005	Grabowski	8,287,574	B2	10/2012	Biyani	
6,945,973	B2	9/2005	Bray	8,317,842	B2	11/2012	Graham	
6,989,012	B2	1/2006	LeHuec	8,348,980	B2	1/2013	Prasad	
7,004,944	B2	2/2006	Gause	8,353,939	B2	1/2013	Anderson	
7,041,105	B2	5/2006	Michelson	8,361,074	B2	1/2013	Flandry, Jr.	
7,044,952	B2	5/2006	Michelson	8,394,130	B2	3/2013	Orbay	
7,060,067	B2	6/2006	Needham	8,394,131	B2	3/2013	Wing	
7,081,119	B2	7/2006	Stihl	8,403,969	B2	3/2013	Wallenstein	
7,094,239	B1	8/2006	Michelson	8,419,777	B2	4/2013	Walker	
7,097,645	B2	8/2006	Michelson	8,425,569	B2	4/2013	O'Farrell	
7,118,573	B2	10/2006	Michelson	8,454,667	B2	6/2013	Humphreys	
7,169,150	B2	1/2007	Shipp	8,523,862	B2	9/2013	Murashko, Jr.	
7,250,053	B2	7/2007	Orbay	8,551,144	B2	10/2013	Youssef	
7,282,053	B2	10/2007	Orbay	8,551,145	B2	10/2013	Huddleston, III	
7,288,094	B2	10/2007	Lindemann	8,556,944	B2	10/2013	Dube	
7,288,095	B2	10/2007	Baynham	8,562,655	B2	10/2013	Butler	
7,303,564	B2	12/2007	Freid	8,613,772	B2	12/2013	Bray	
7,306,605	B2	12/2007	Ross	8,685,069	B2	4/2014	Courtney	
7,318,825	B2	1/2008	Butler	8,740,915	B2	6/2014	Niederberger	
D581,055	S	11/2008	Mateyka	8,784,457	B2	7/2014	Graham	
7,481,829	B2	1/2009	Baynham	8,790,378	B2	7/2014	Castaneda	
7,488,327	B2	2/2009	Rathbun	8,808,333	B2	8/2014	Kuster	
D592,946	S	5/2009	Johnson	8,845,697	B2	9/2014	Montello	
7,527,640	B2	5/2009	Ziolo	8,882,813	B2	11/2014	Jones	
7,527,641	B2	5/2009	Suh	8,906,077	B2	12/2014	Bush, Jr.	
D597,673	S	8/2009	Smisson, III	2002/0062127	A1	5/2002	Schumacher	
D598,104	S *	8/2009	Bush, Jr.	2003/0036759	A1	2/2003	Musso	
D602,589	S *	10/2009	Bush, Jr.	2004/0019353	A1	1/2004	Freid	
D603,503	S *	11/2009	Kriska	2004/0097936	A1	5/2004	Ebid	
D603,504	S *	11/2009	Kriska	2004/0153160	A1	8/2004	Carrasco	
D603,505	S *	11/2009	Kriska	2004/0158250	A1	8/2004	Chappuis	
D603,506	S *	11/2009	Kriska	2004/0193155	A1	9/2004	Castaneda	
D603,507	S *	11/2009	Kriska	2005/0015093	A1	1/2005	Suh	
D603,508	S *	11/2009	Kriska	2005/0033430	A1	2/2005	Powers	
D603,509	S *	11/2009	Kriska	2005/0049595	A1	3/2005	Suh	
D603,510	S *	11/2009	Kriska	2005/0101959	A1	5/2005	Mitkovic	
D603,511	S *	11/2009	Kriska	2005/0107795	A1	5/2005	Morris	
D603,512	S *	11/2009	Kriska	2005/0187551	A1	8/2005	Orbay	
D603,961	S *	11/2009	Kriska	2005/0203627	A1	9/2005	Choksey	
D603,962	S *	11/2009	Kriska	2006/0056613	A1	3/2006	Kim	
D603,963	S *	11/2009	Kriska	2006/0122605	A1	6/2006	Suh	
D603,964	S *	11/2009	Kriska	2006/0221247	A1	10/2006	Doyen	
7,625,375	B2	12/2009	Garden	2006/0235409	A1	10/2006	Blain	
7,674,279	B2	3/2010	Johnson	2006/0293668	A1	12/2006	May	
7,686,808	B2	3/2010	Orbay	2007/0055250	A1	3/2007	Aflatoon	
				2007/0162019	A1	7/2007	Burns	
				2007/0173840	A1	7/2007	Huebner	
				2007/0233108	A1	10/2007	Stalcup	

US D779,065 S

(56)	References Cited				
	U.S. PATENT DOCUMENTS				
2007/0270849	A1	11/2007	Orbay	CN	201308534 Y 9/2009
2008/0183172	A1	7/2008	Fritzinger	CN	201324284 Y 10/2009
2008/0234753	A1	9/2008	Trieu	CN	201586062 U 9/2010
2008/0306550	A1	12/2008	Matityahu	CN	101953712 A 1/2011
2008/0312699	A1	12/2008	Johnson	CN	101972162 A 2/2011
2009/0043341	A1	2/2009	Tyber	CN	201759658 U 3/2011
2009/0163960	A1	6/2009	Binder	CN	201831944 U 5/2011
2009/0270928	A1	10/2009	Stone	CN	201847761 U 6/2011
2009/0287257	A1	11/2009	Hagen	CN	202044331 U 11/2011
2009/0287258	A1	11/2009	Vannemreddy	CN	102362815 A 2/2012
2010/0016858	A1	1/2010	Michel	CN	202223333 U 5/2012
2010/0016901	A1	1/2010	Robinson	CN	202342170 U 7/2012
2010/0057127	A1	3/2010	McGuire	CN	202409108 U 9/2012
2010/0057134	A1	3/2010	Lowry	CN	202409123 U 9/2012
2010/0087871	A1	4/2010	Loyola	CN	202409127 U 9/2012
2010/0121383	A1	5/2010	Stanaford	CN	202568423 U 12/2012
2010/0152783	A1	6/2010	Borostyankoi	CN	102846363 A 1/2013
2011/0264149	A1	10/2011	Pappalardo	CN	102871717 A 1/2013
2011/0282389	A1	11/2011	Janice	CN	202665675 U 1/2013
2011/0301608	A1	12/2011	Roth	CN	202843762 U 4/2013
2012/0022600	A1	1/2012	Overes	CN	202843768 U 4/2013
2012/0053587	A1	3/2012	Kiritsis	CN	202859275 U 4/2013
2012/0071931	A1	3/2012	Perez-Cruet	CN	202892074 U 4/2013
2012/0130496	A1	5/2012	Duffield	CN	202942203 U 5/2013
2012/0136392	A1	5/2012	Keegan	CN	202982197 U 6/2013
2012/0209334	A1	8/2012	Lewis	CN	203107261 U 8/2013
2012/0277803	A1	11/2012	Remesh	DE	7915573 U1 5/1979
2012/0303031	A1	11/2012	Cocancig	DE	8528003 U1 1/1986
2013/0006309	A1	1/2013	Lorio	DE	9217768 U1 5/1993
2013/0018424	A1	1/2013	Subik	DE	9217769 U1 5/1993
2013/0053895	A1	2/2013	Stoll	DE	9315148 U1 1/1994
2013/0053898	A1	2/2013	Voisard	DE	4438264 A1 3/1996
2013/0072988	A1	3/2013	Hulliger	DE	8213228 U1 1/2000
2013/0211463	A1	8/2013	Mizuno	DE	10240653 A1 5/2003
2013/0238095	A1	9/2013	Pavento	DE	20317651 U1 3/2004
2014/0039498	A1	2/2014	Chatain	DE	102006012581 A1 4/2007
				DE	202009008872 U1 9/2009
				DE	202011107822 U1 5/2012
				EP	0542004 A1 5/1993
				EP	1520545 A1 4/2005
				EP	2433580 A1 3/2012
				ES	2078085 T3 12/1995
				FR	2405062 A1 5/1979
				FR	2740674 A1 5/1997
CN	2498996	Y	7/2002	JP	2010220762 A 10/2010
CN	1366866	A	9/2002	JP	2010233915 A 10/2010
CN	1372869	A	10/2002	KR	20020010449 A 2/2002
CN	2517396	Y	10/2002	KR	20050023433 A 3/2005
CN	2543495	Y	4/2003	KR	20070022261 A 2/2007
CN	2631438	Y	8/2004	KR	100974498 B1 8/2010
CN	1748655	A	3/2006	RU	2011119282 A 11/2012
CN	2822542	Y	10/2006	WO	WO9722306 A1 6/1997
CN	2882556	Y	3/2007	WO	WO2004017837 A2 3/2004
CN	200980723	Y	11/2007	WO	WO2005034780 A1 4/2005
CN	201042458	Y	4/2008	WO	WO2006022644 A1 3/2006
CN	201055419	Y	5/2008		
CN	201260694	Y	6/2009		

* cited by examiner

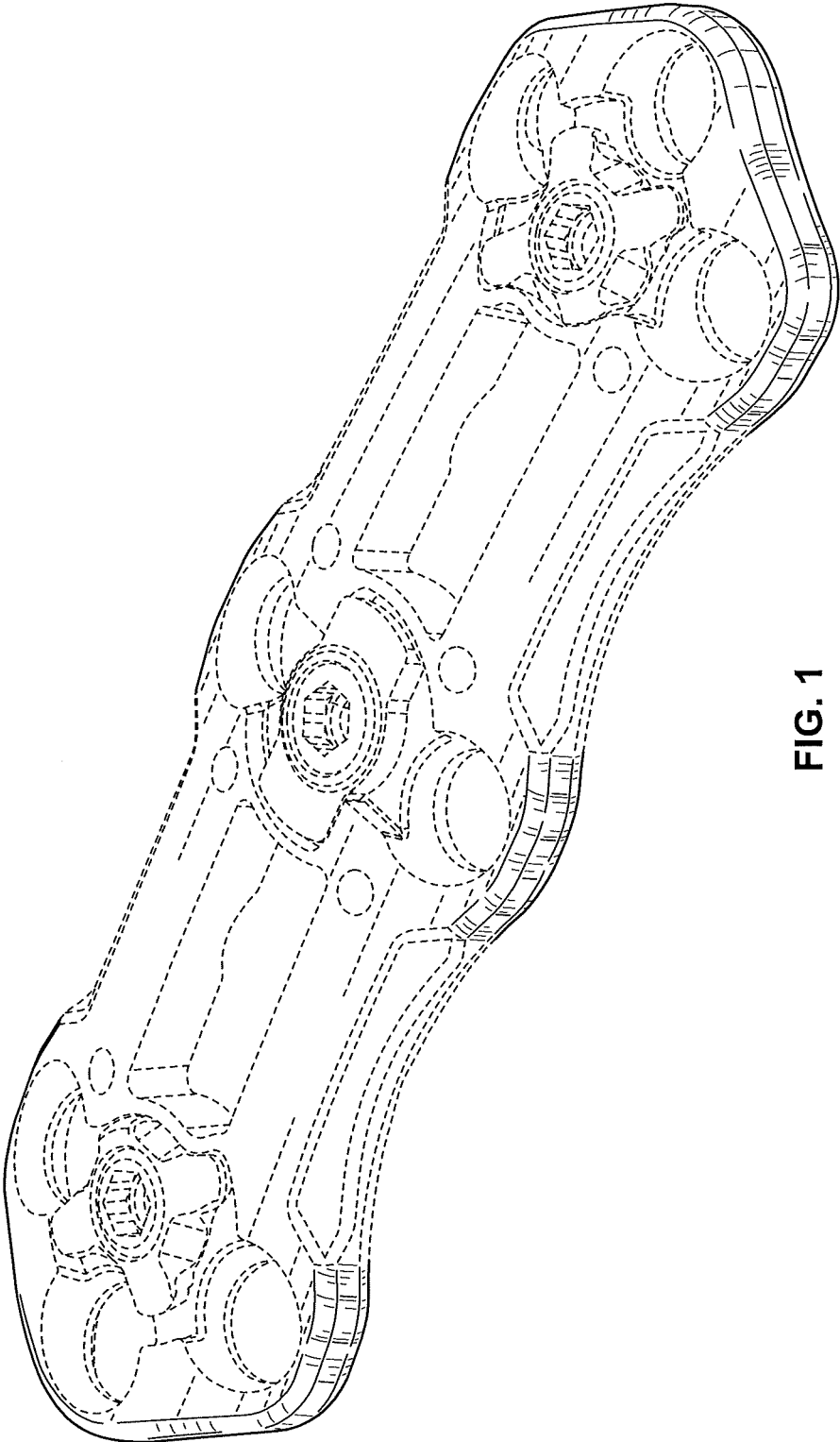

FIG. 1

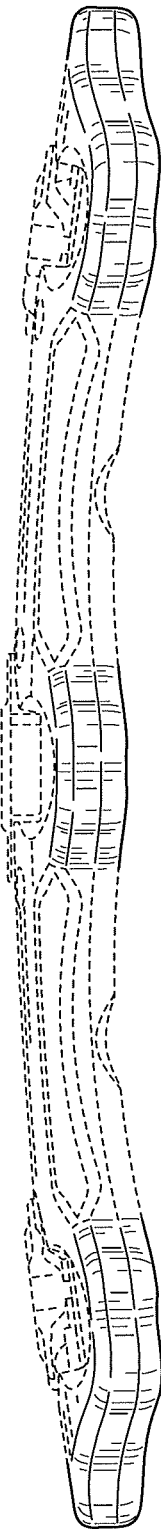

FIG. 2

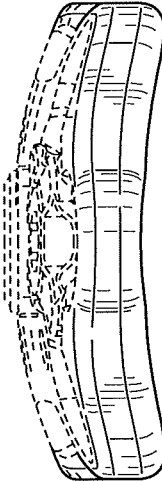

FIG. 3

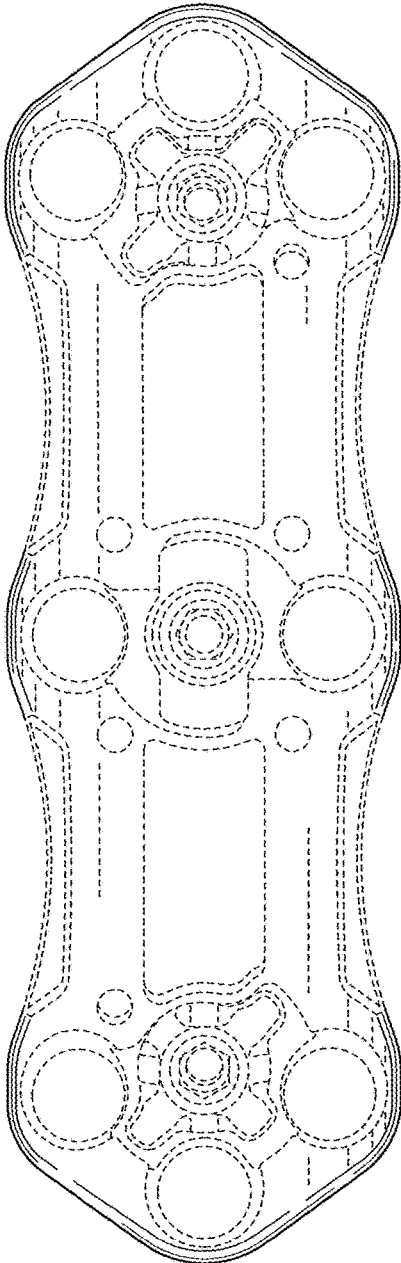

FIG. 4

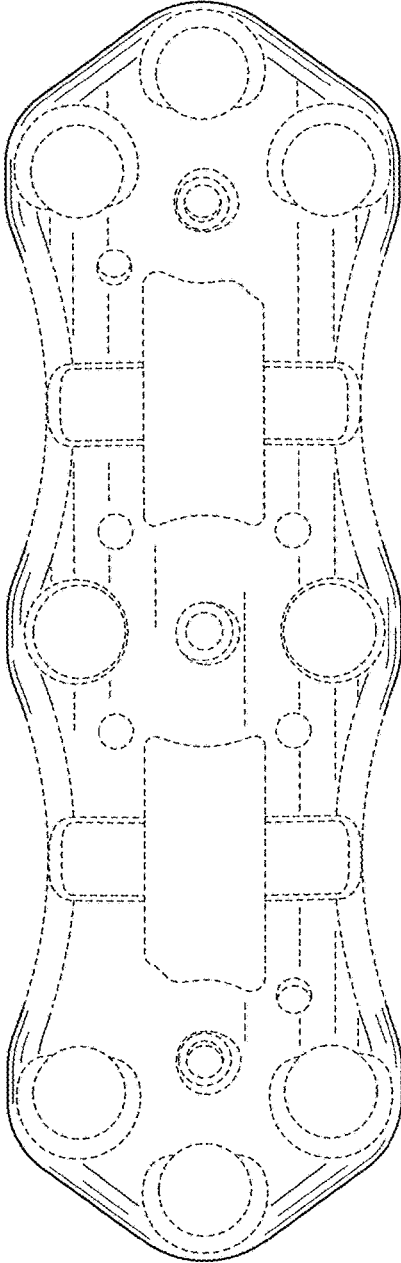

FIG. 5

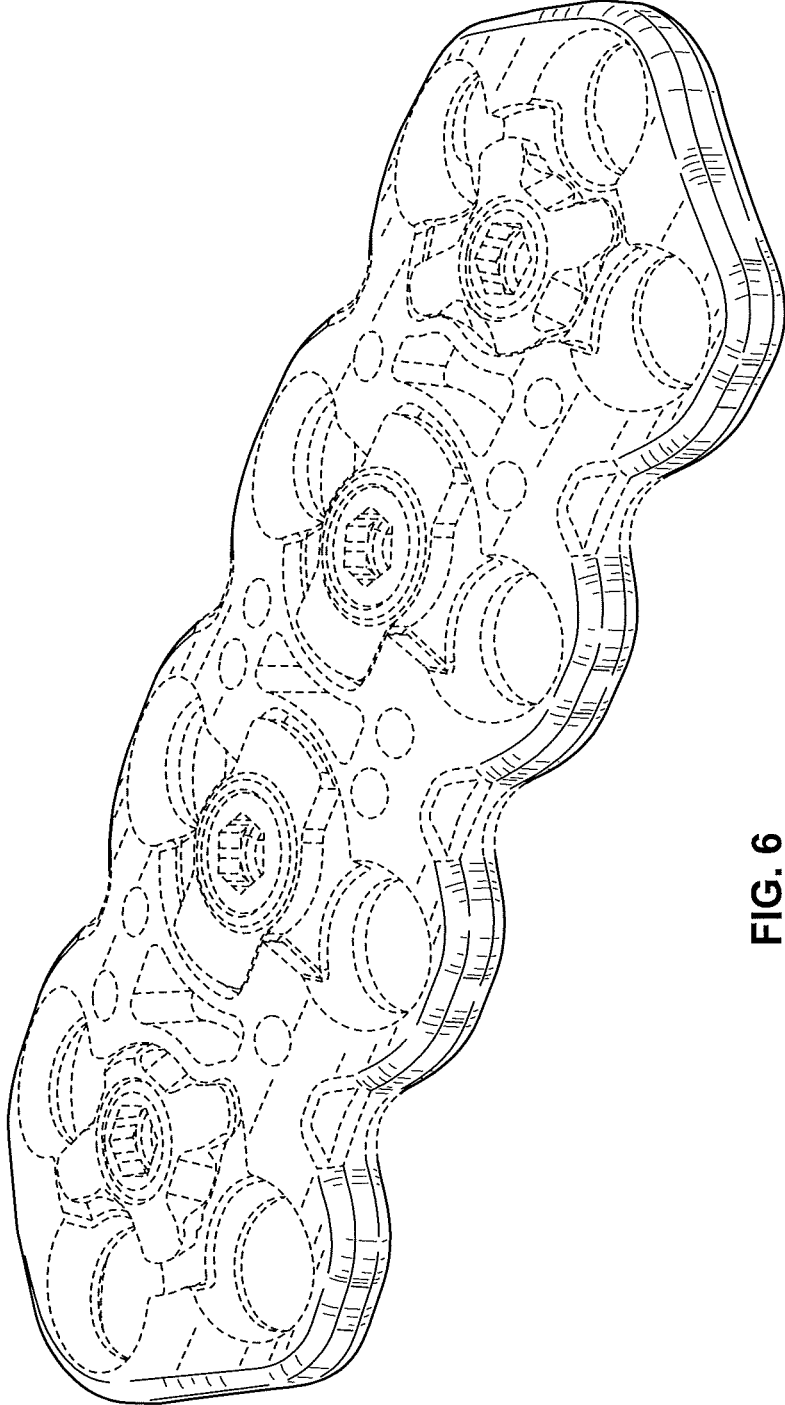

FIG. 6

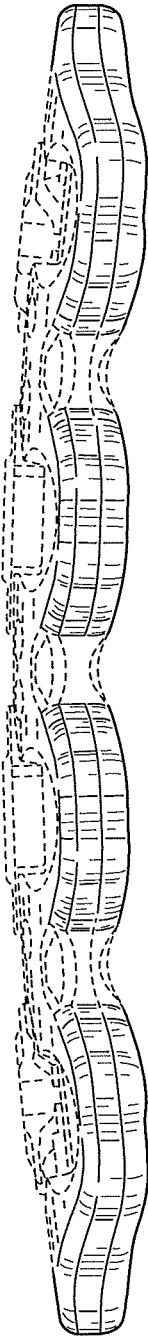

FIG. 7

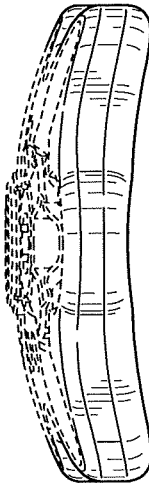

FIG. 8

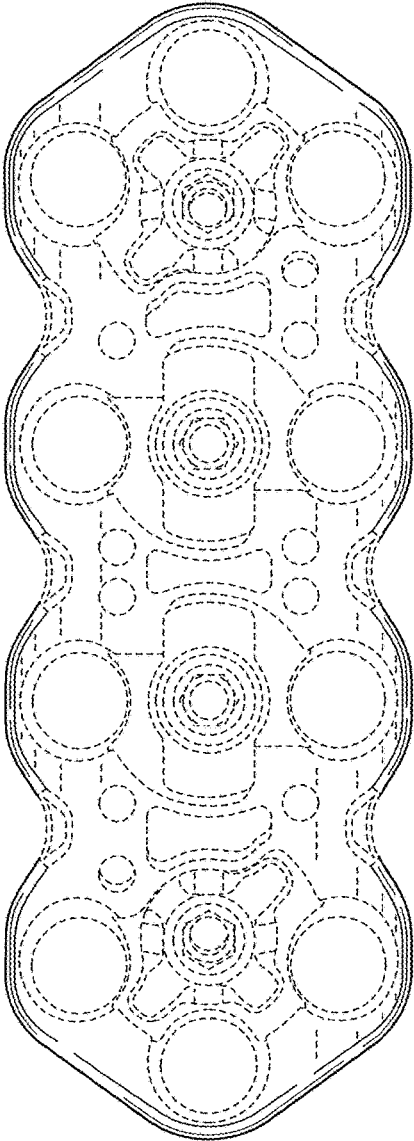

FIG. 9

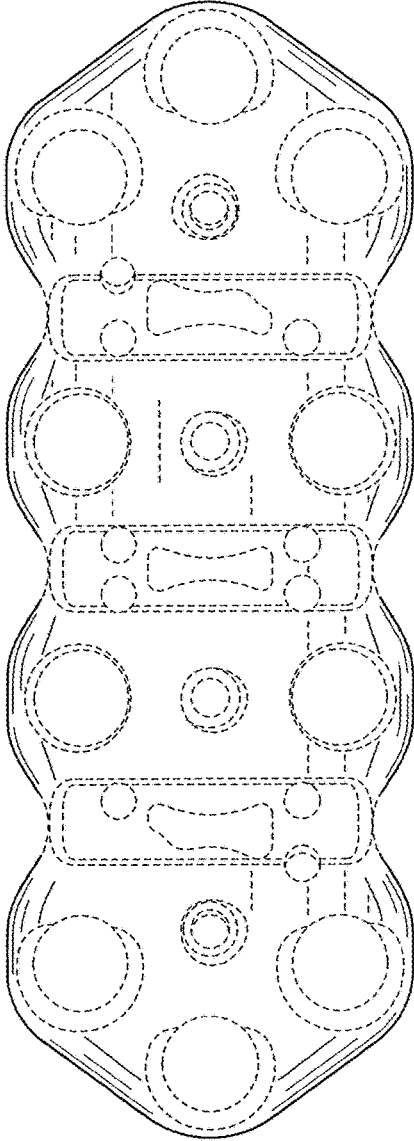

FIG. 10

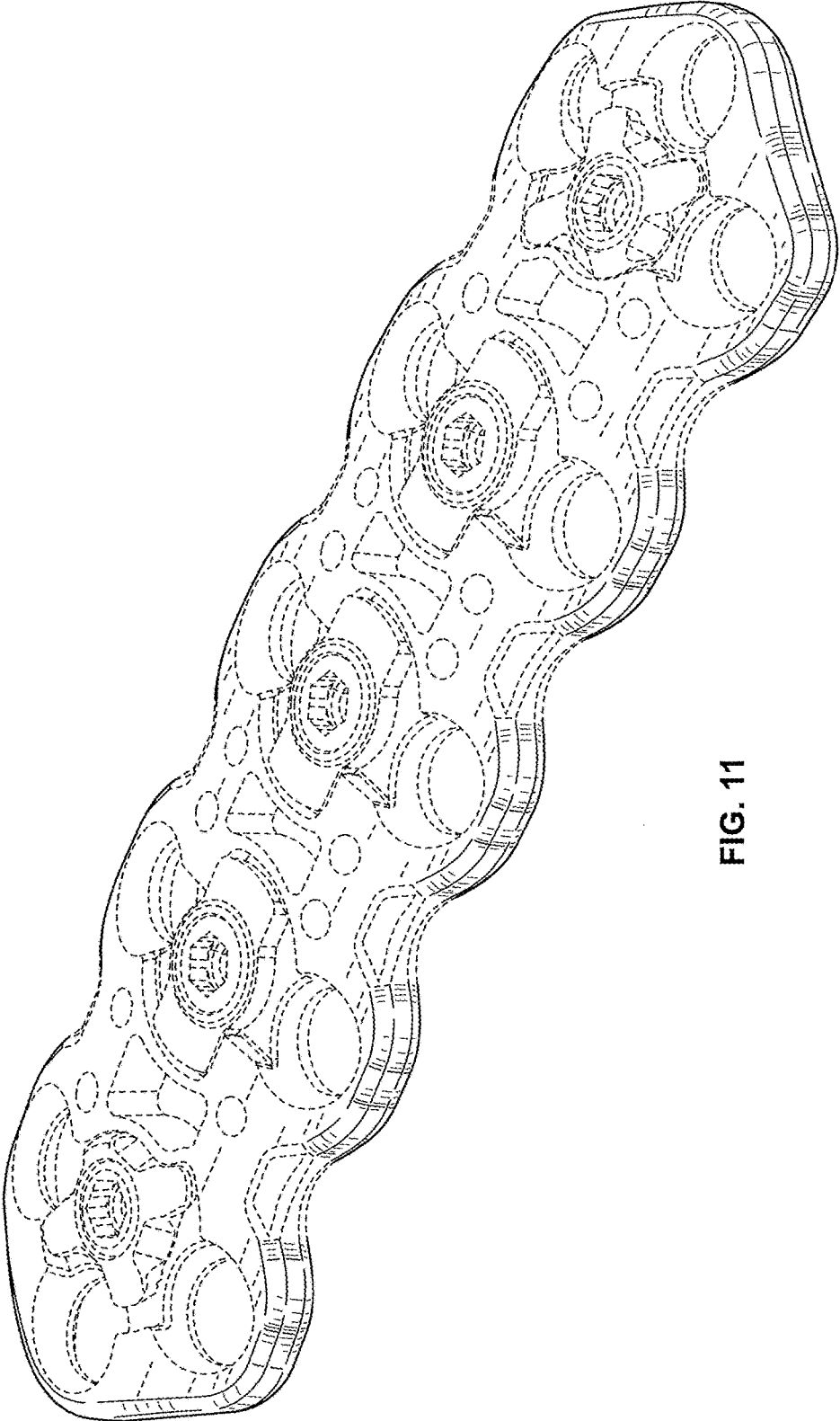

FIG. 11

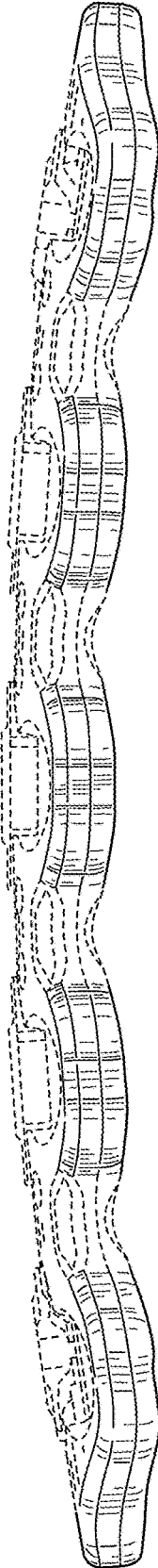

FIG. 12

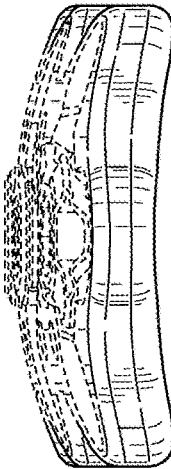

FIG. 13

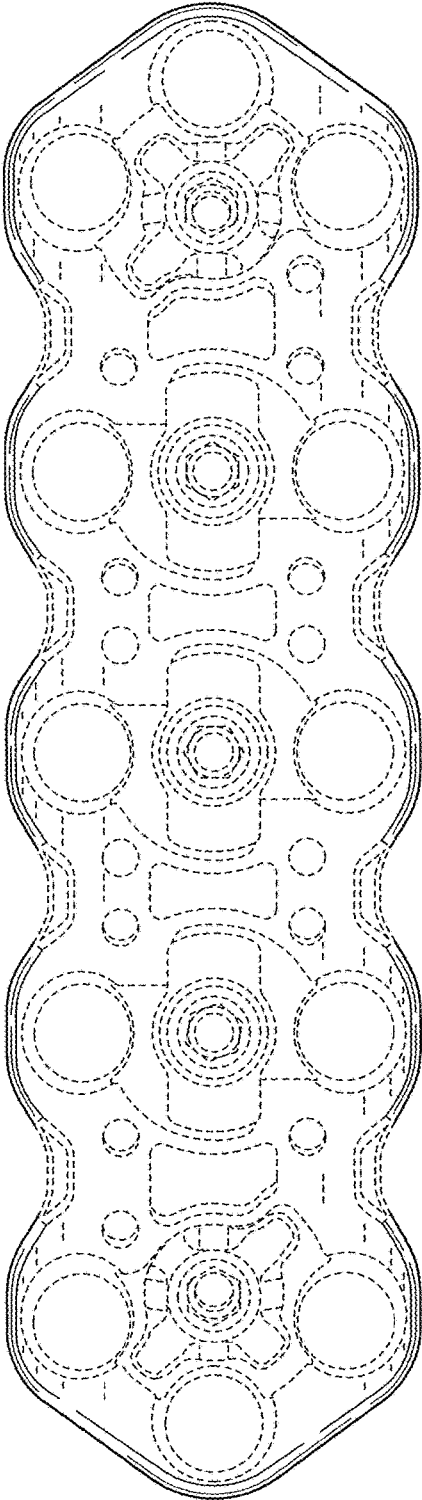

FIG. 14

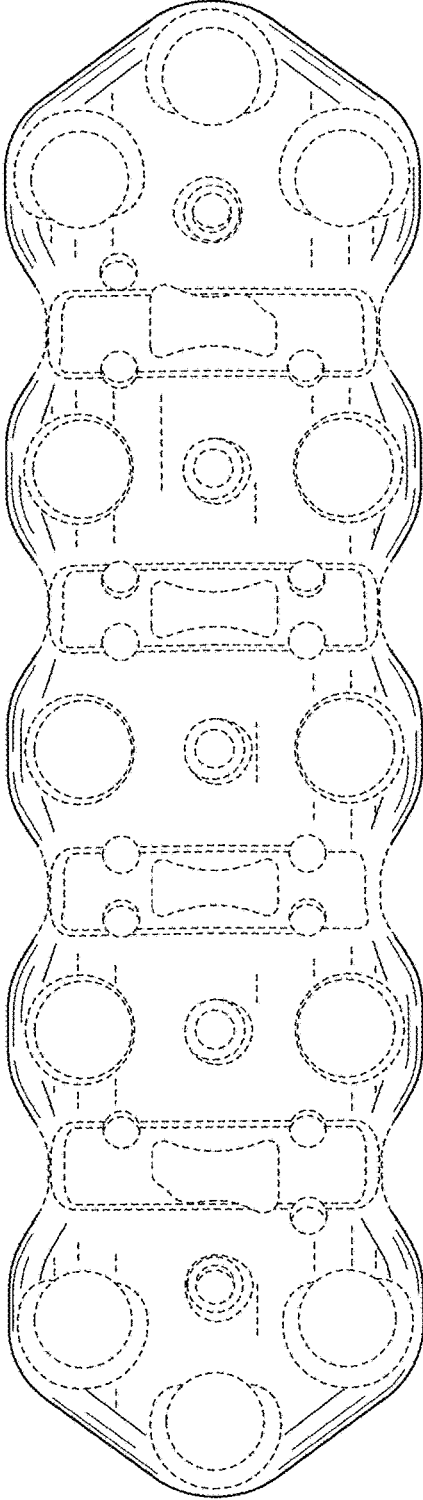

FIG. 15

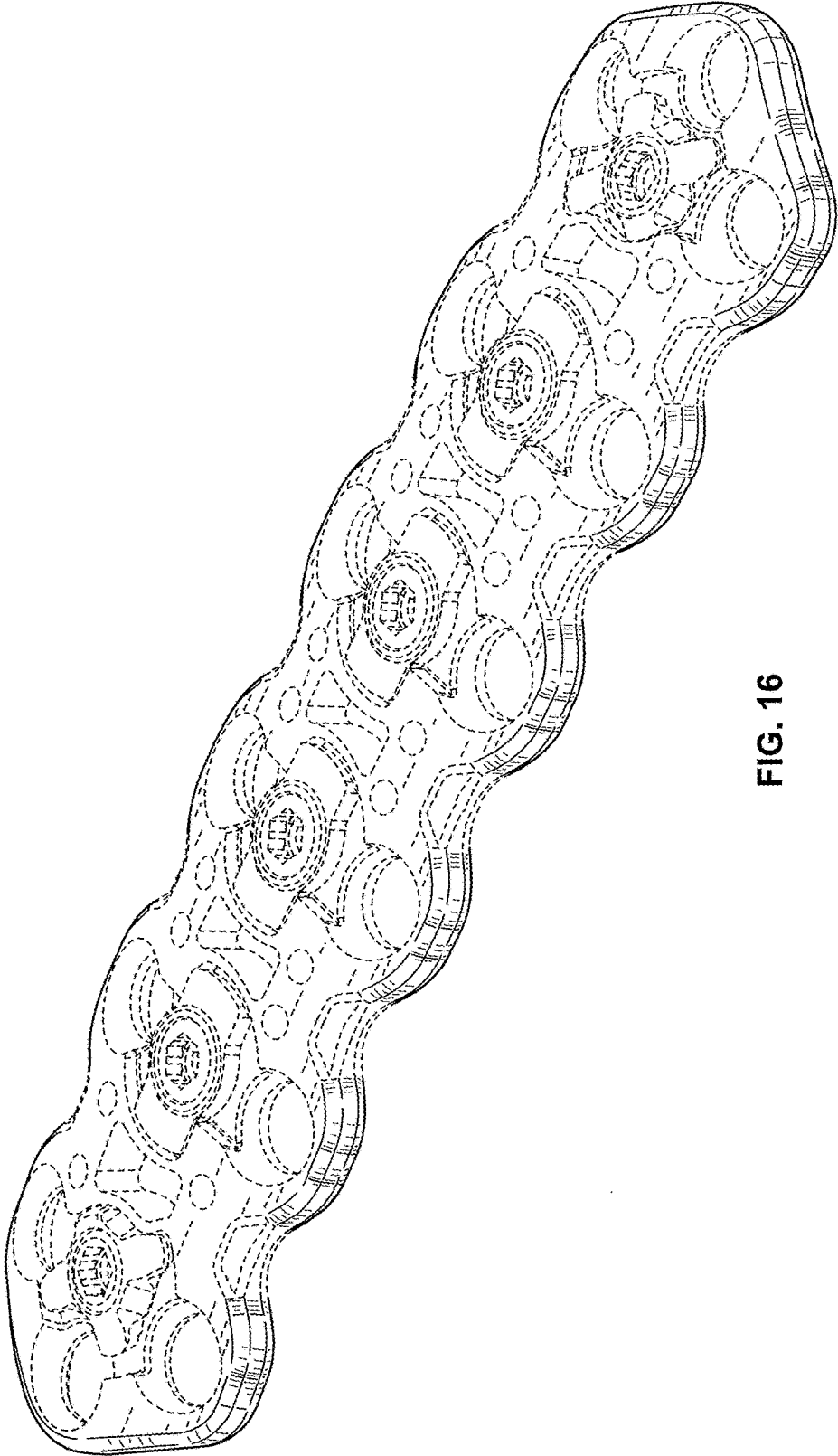

FIG. 16

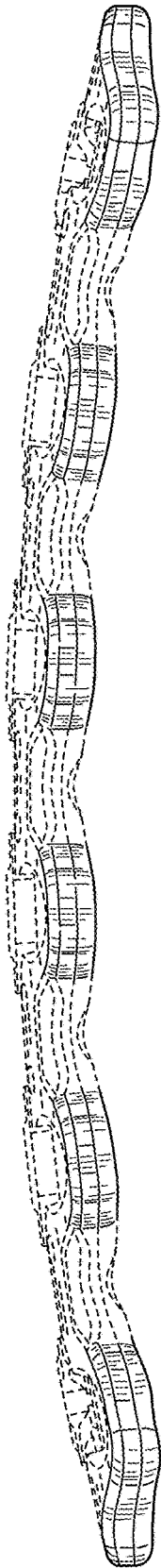

FIG. 17

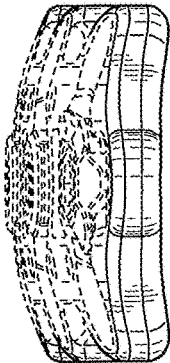

FIG. 18

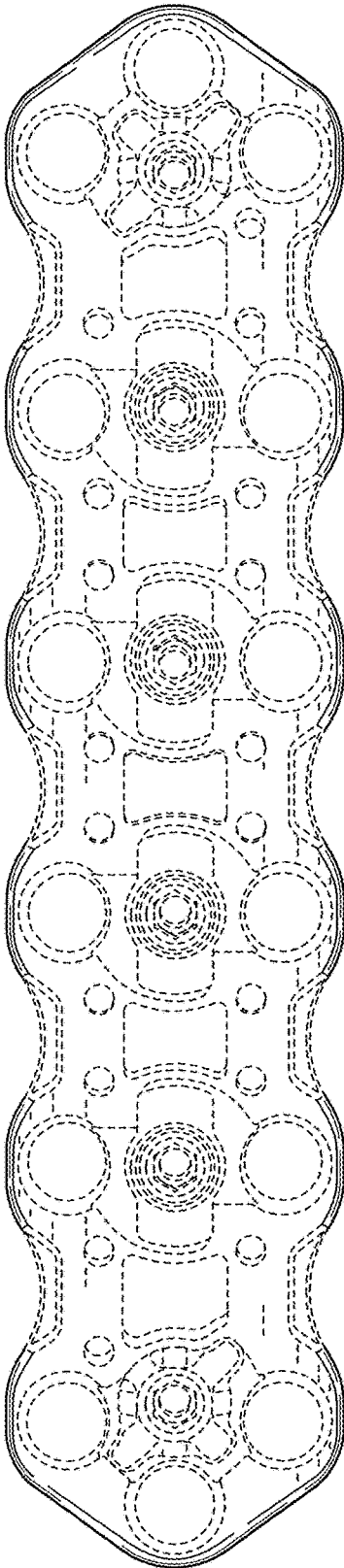

FIG. 19

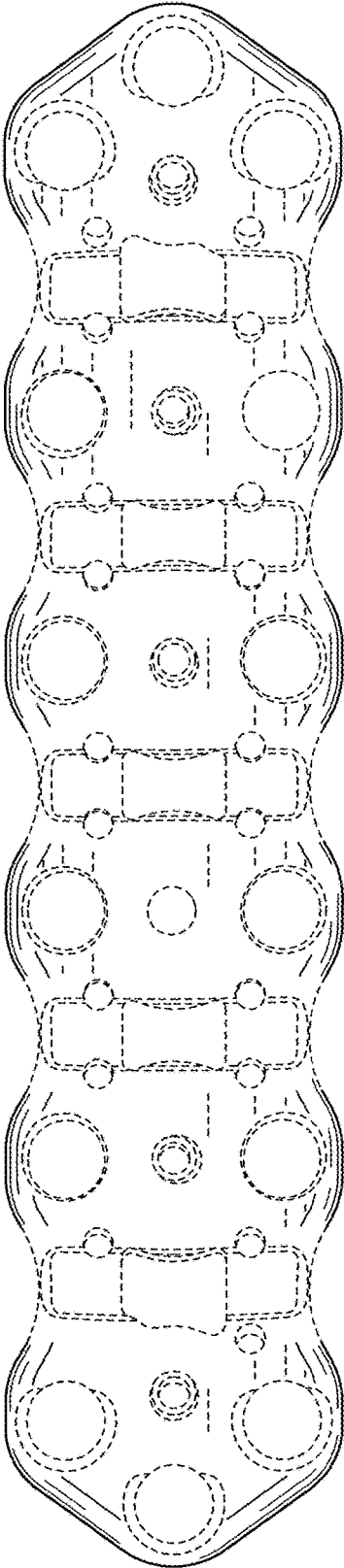

FIG. 20