



US00D685692S

(12) **United States Design Patent**
Platto et al.

(10) **Patent No.:** **US D685,692 S**

(45) **Date of Patent:** **** Jul. 9, 2013**

(54) **VEHICLE FRONT LOWER GRILLE**

(75) Inventors: **Gordon M. Platto**, Troy, MI (US);
Bradley Alan Richards, Bloomfield
Hills, MI (US); **Shawn Sung Yu**,
Shanghai (CN); **Timothy Doyle**, Royal
Oak, MI (US)

(73) Assignee: **Ford Motor Company**, Dearborn, MI
(US)

(**) Term: **14 Years**

(21) Appl. No.: **29/411,518**

(22) Filed: **Jan. 23, 2012**

(51) **LOC (9) Cl.** **12-16**

(52) **U.S. Cl.**
USPC **D12/163**

(58) **Field of Classification Search**
USPC D12/163, 196, 171, 169, 216, 90-92,
D12/86; 180/68.1, 68.6; 296/193.11
See application file for complete search history.

(56) **References Cited**

U.S. PATENT DOCUMENTS

D561,654 S *	2/2008	Platto et al.	D12/163
D578,443 S *	10/2008	Schiavone et al.	D12/163
D584,196 S *	1/2009	Ebel et al.	D12/163
D584,197 S *	1/2009	Song et al.	D12/163

D586,267 S *	2/2009	Ebel et al.	D12/163
D619,057 S *	7/2010	George et al.	D12/163
D626,897 S *	11/2010	Ectors et al.	D12/163
D644,965 S *	9/2011	Tonello	D12/163
D644,966 S *	9/2011	Tonello	D12/163
D644,967 S *	9/2011	Tonello	D12/163
D664,481 S *	7/2012	Platto et al.	D12/163
D664,484 S *	7/2012	Kawaguchi	D12/169
D665,316 S *	8/2012	Asakura	D12/163

* cited by examiner

Primary Examiner — Melody Brown

(74) *Attorney, Agent, or Firm* — Damian Porcari

(57) **CLAIM**

The ornamental design for a vehicle front lower grille, as shown and described.

DESCRIPTION

FIG. 1 is a top plan view of a vehicle front lower grille;
FIG. 2 is a bottom plan view of the vehicle front lower grille;
FIG. 3 is a front elevational view of the vehicle front lower grille;
FIG. 4 is a left side elevational view of the vehicle front lower grille;
FIG. 5 is a right side elevational view of the vehicle front lower grille;
FIG. 6 is a perspective view of the vehicle front lower grille;
and,
FIG. 7 is another perspective view of the vehicle front lower grille.

1 Claim, 7 Drawing Sheets

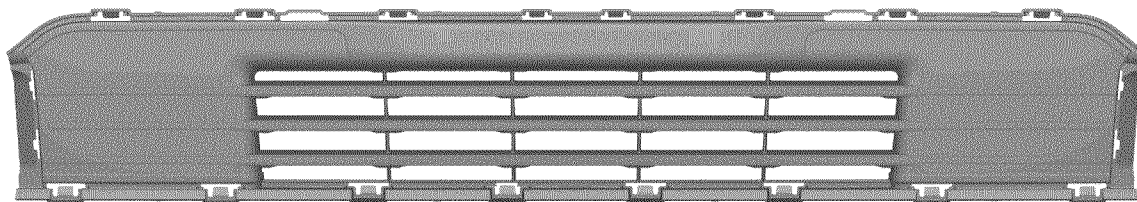

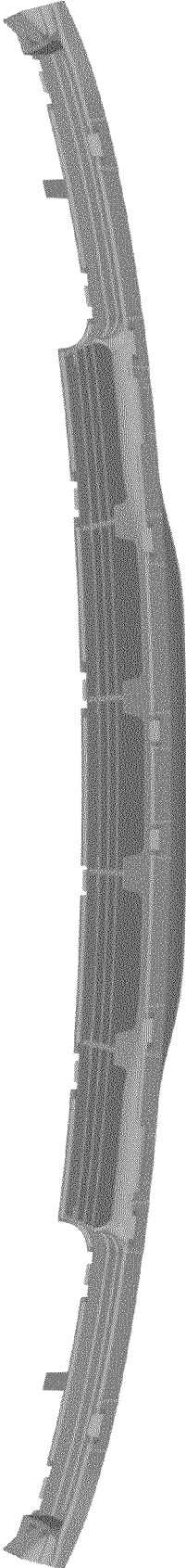

Figure 1

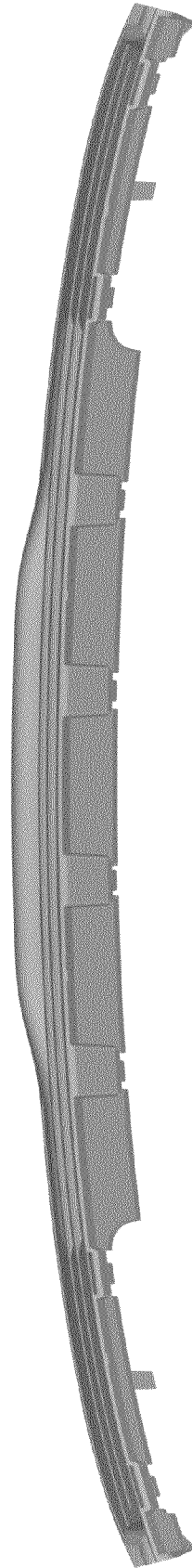

Figure 2

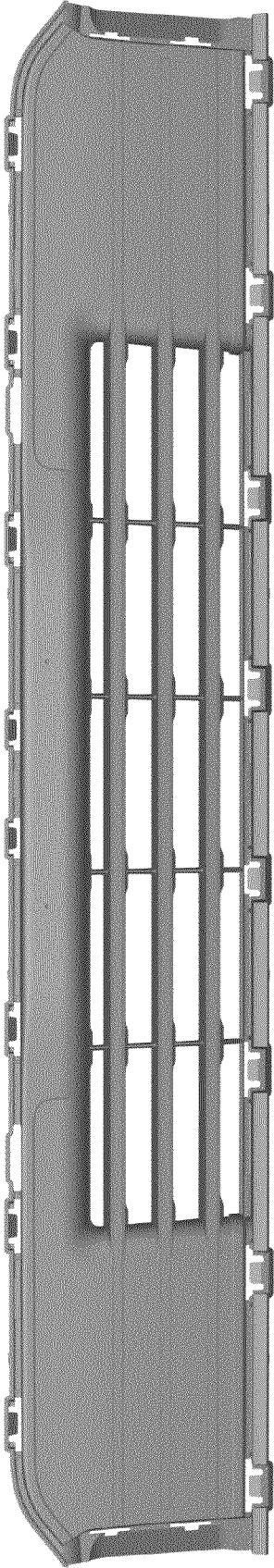

Figure 3

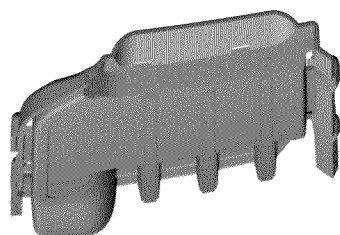

Figure 4

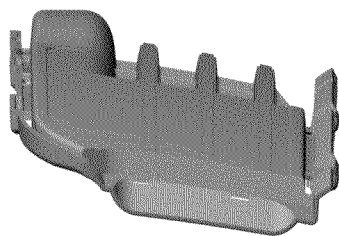

Figure 5

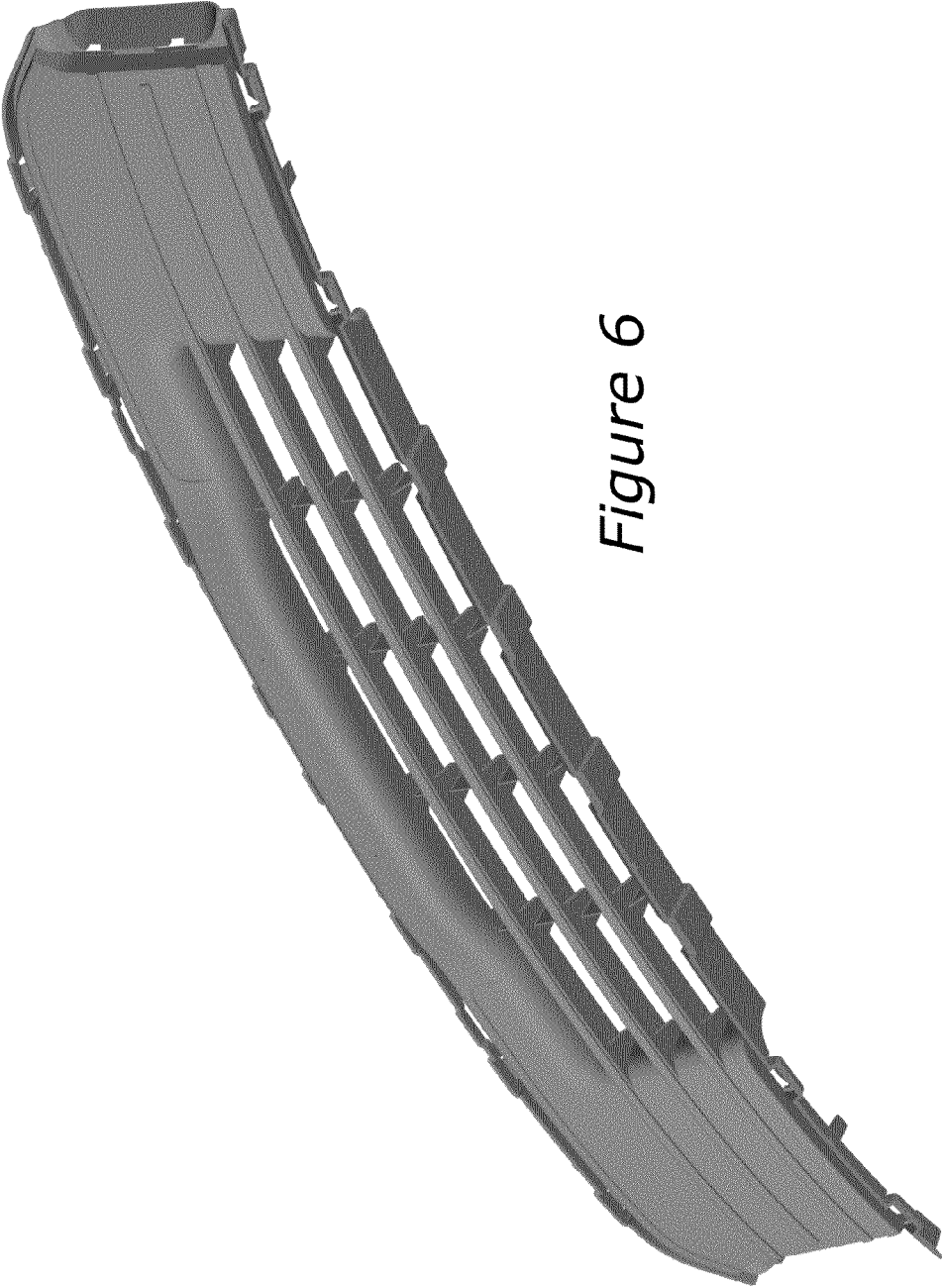

Figure 6

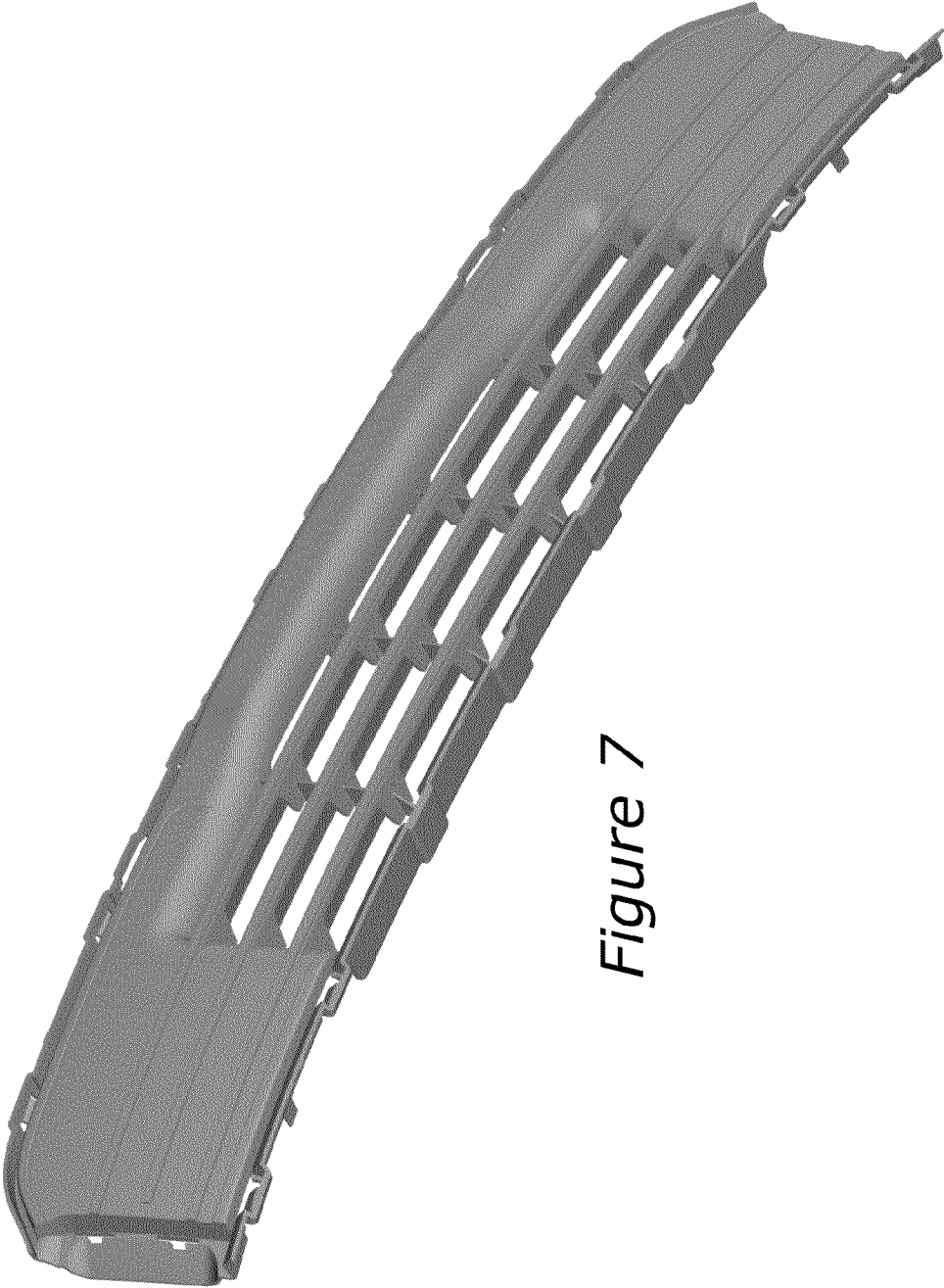

Figure 7