

FIG. 1

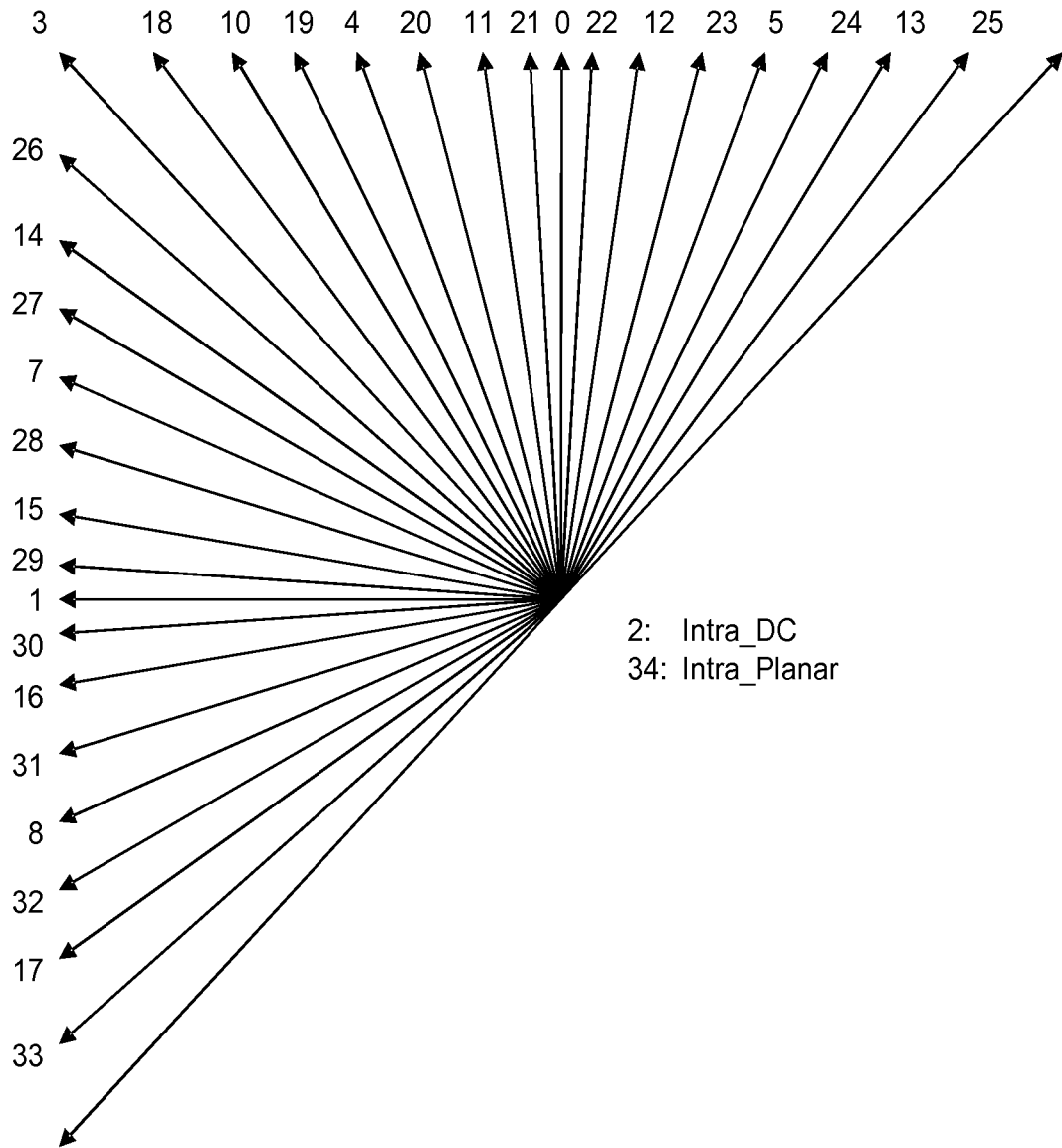
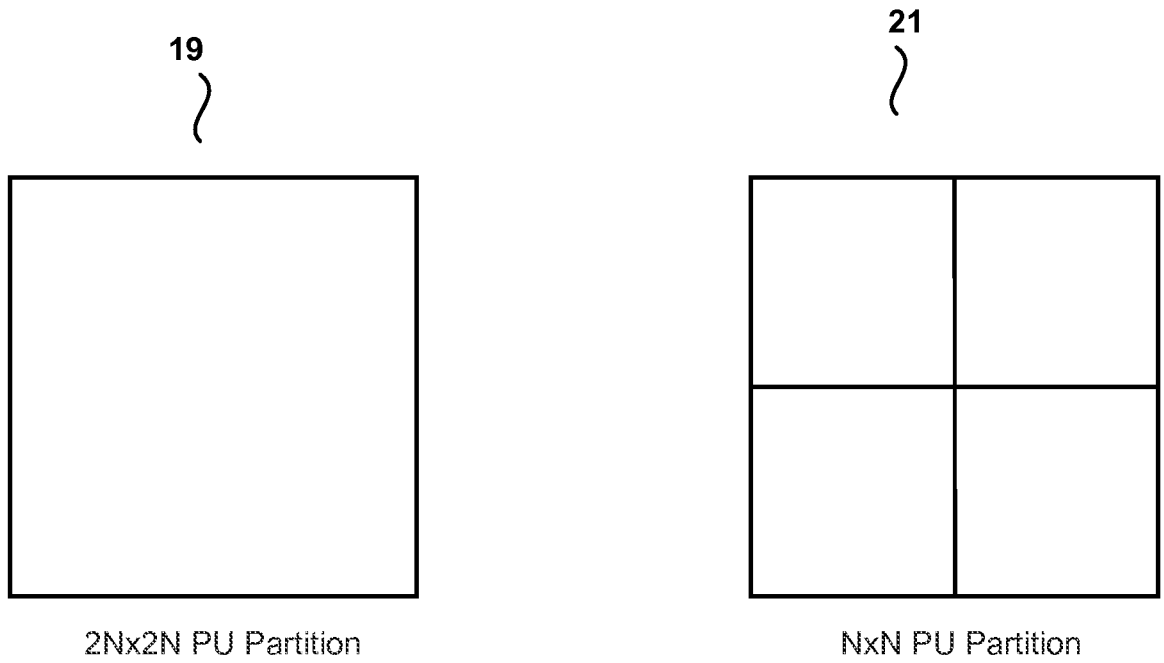

FIG. 2



**FIG. 3**

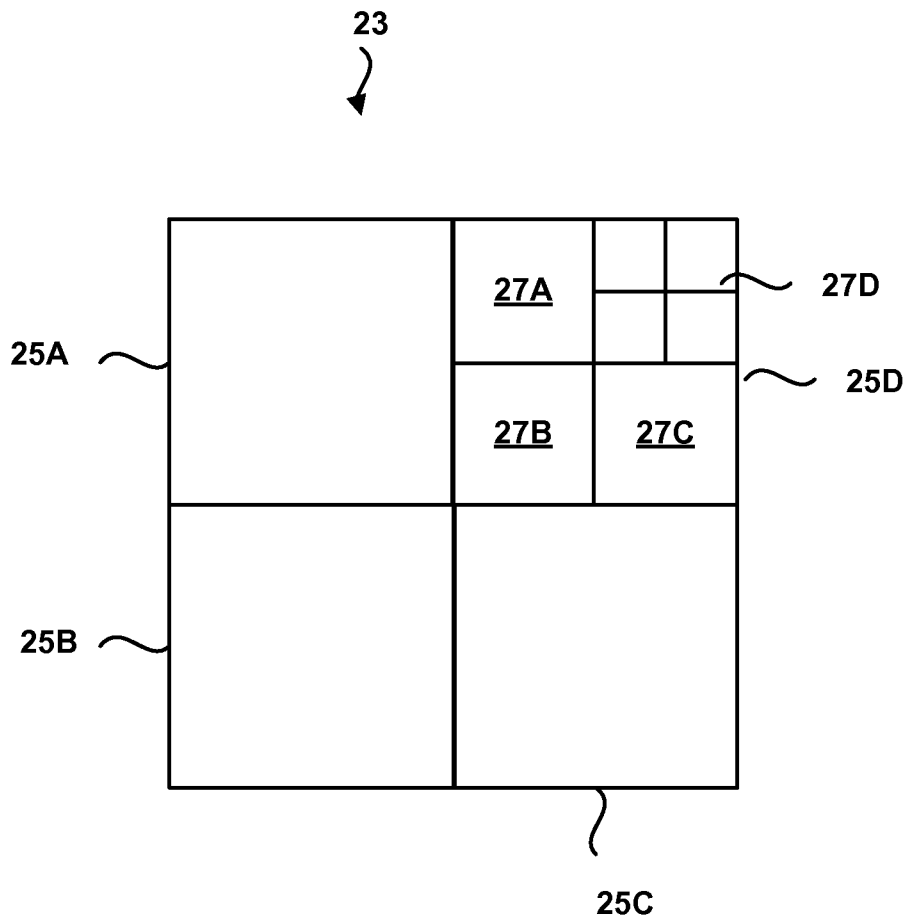

FIG. 4

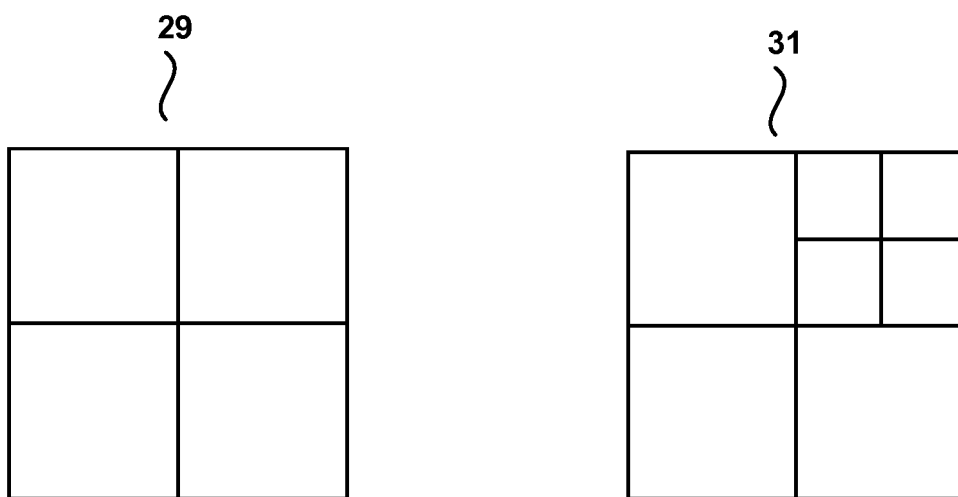
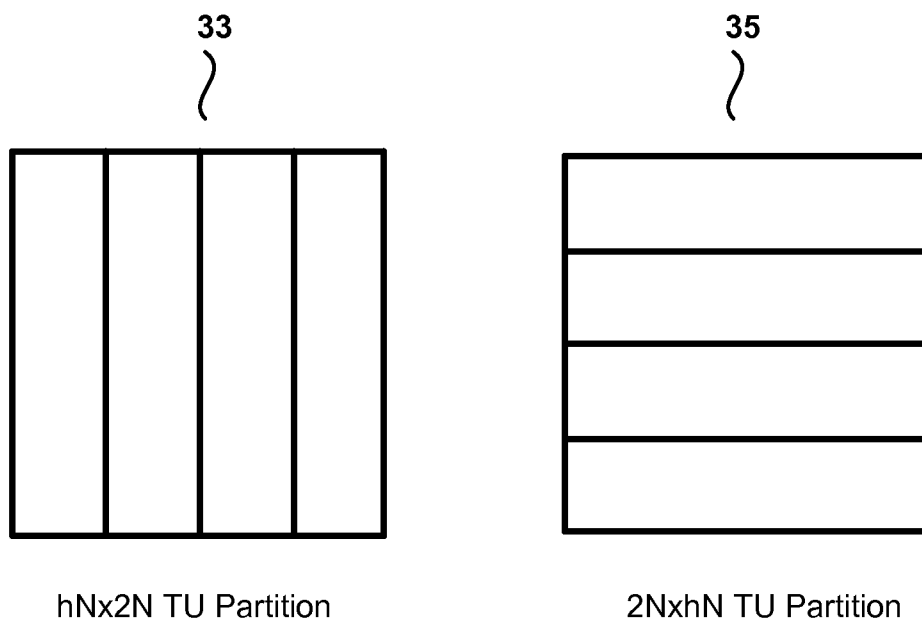
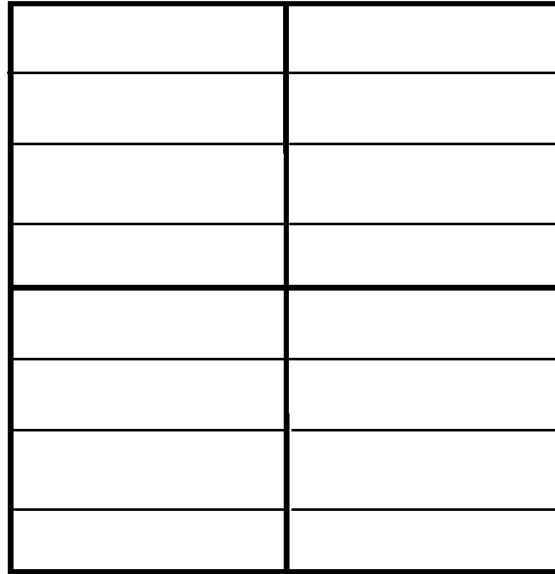

FIG. 5



**FIG. 6**

37  
↓



2NxhN TU Partitions

39  
←

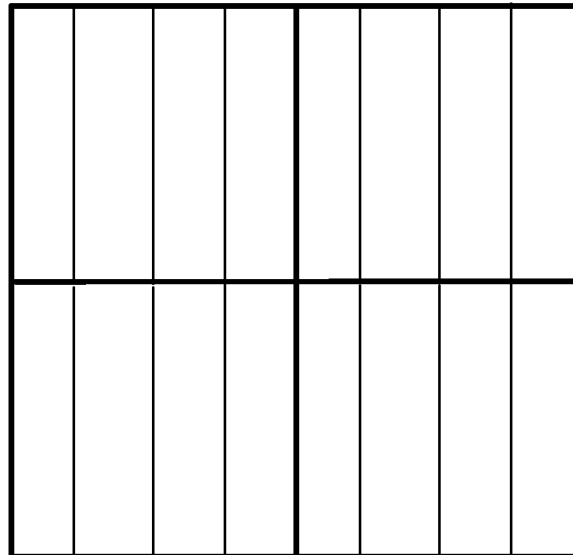

hNx2N TU Partitions

FIG. 7

41  
↙

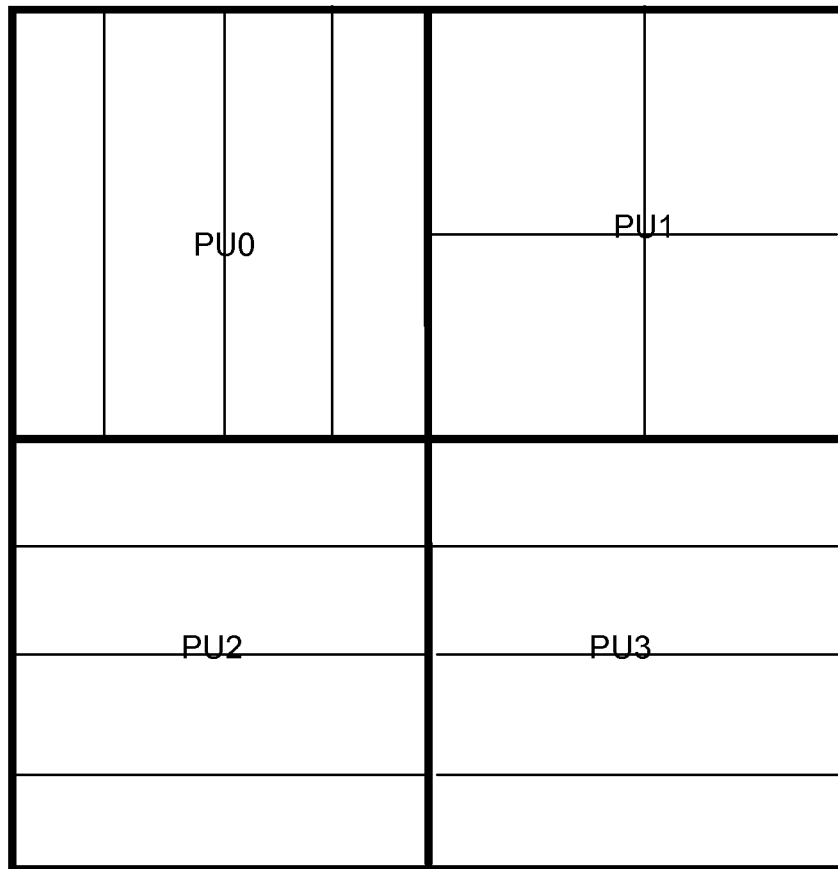
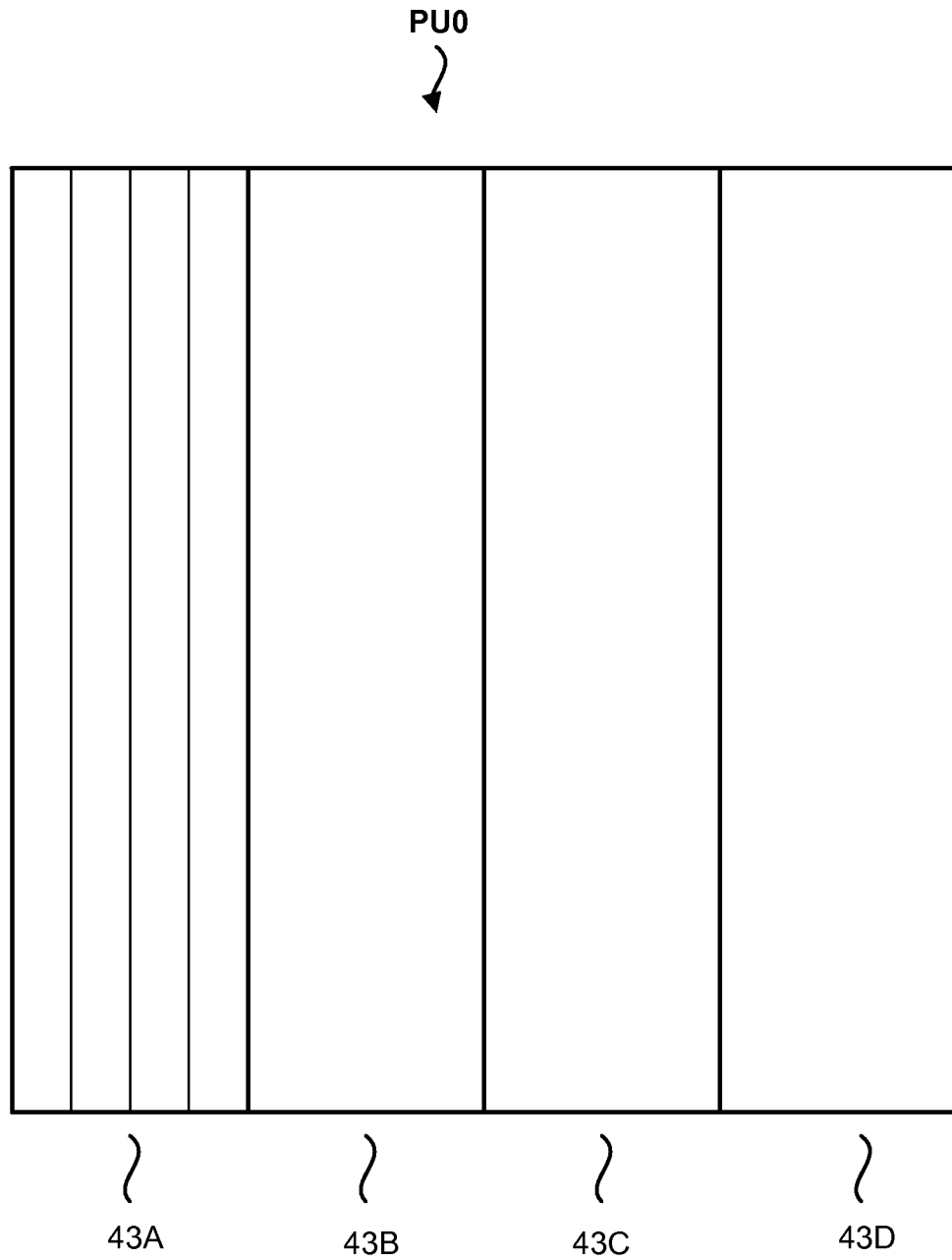
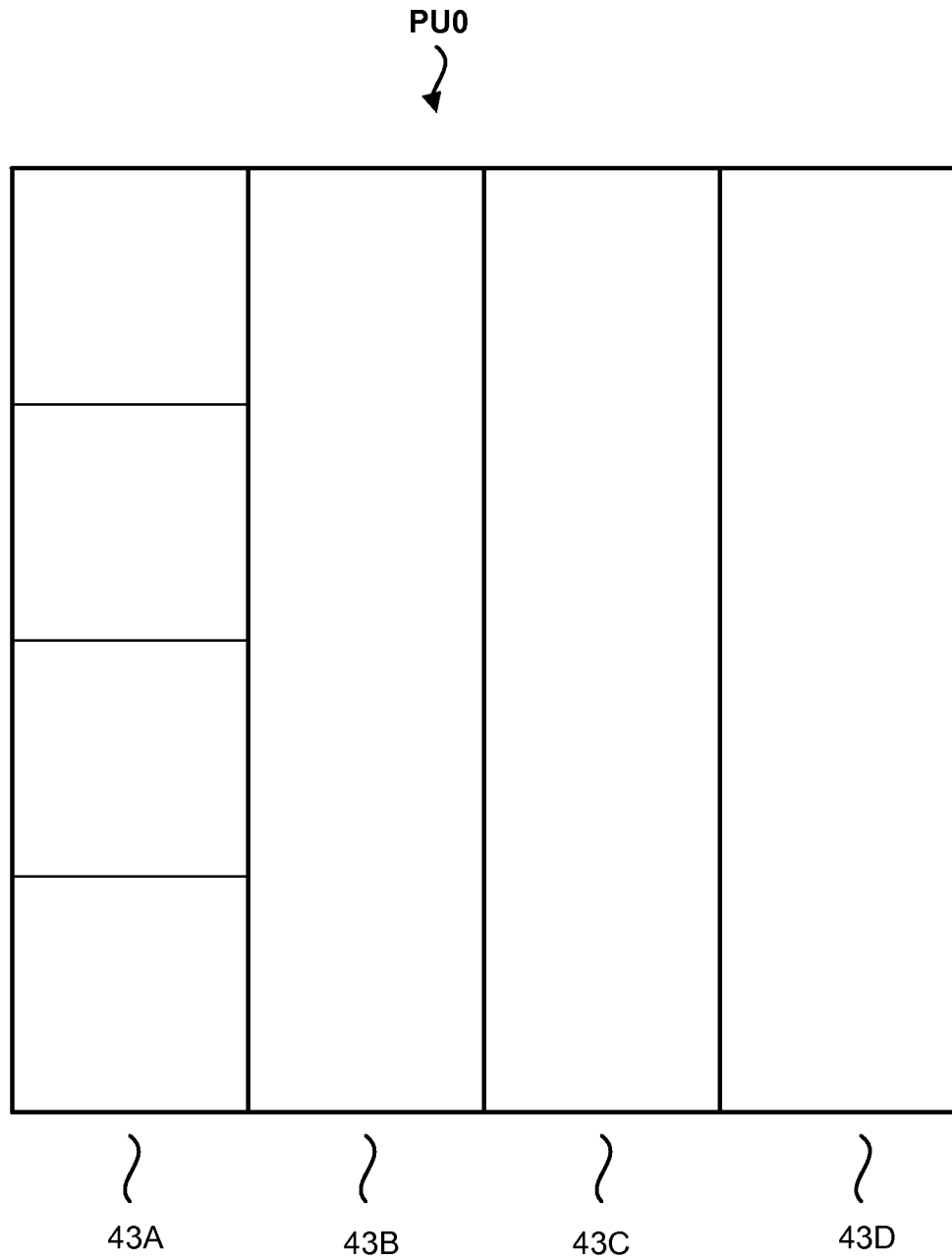

FIG. 8



**1/16NxN Partitioning of Sub-block 43A**

**FIG. 9**



**1/4Nx1/4N Partitioning of Sub-block 43A**

**FIG. 10**

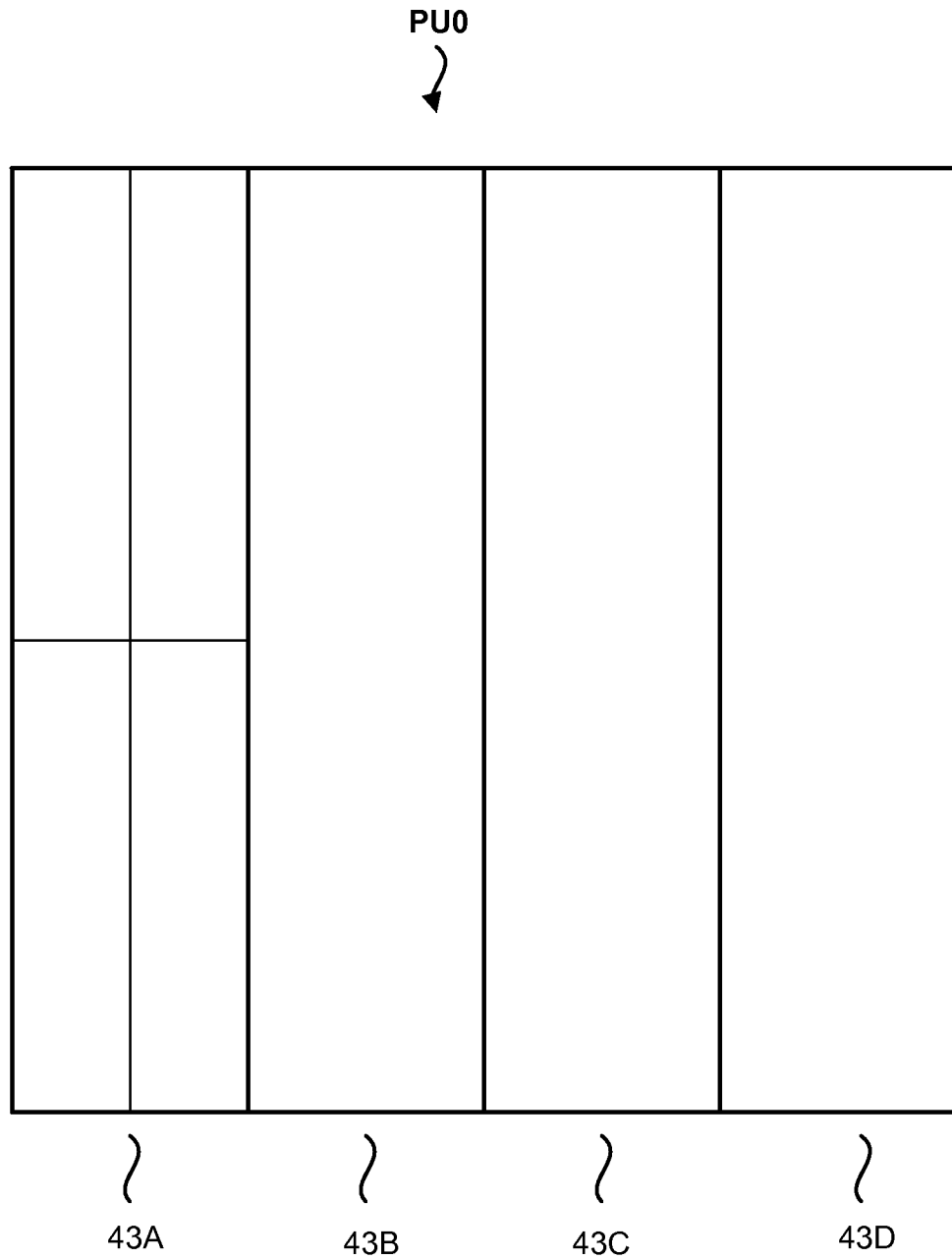

**1/8Nx1/2N Partitioning of Sub-block 43A**

**FIG. 11**

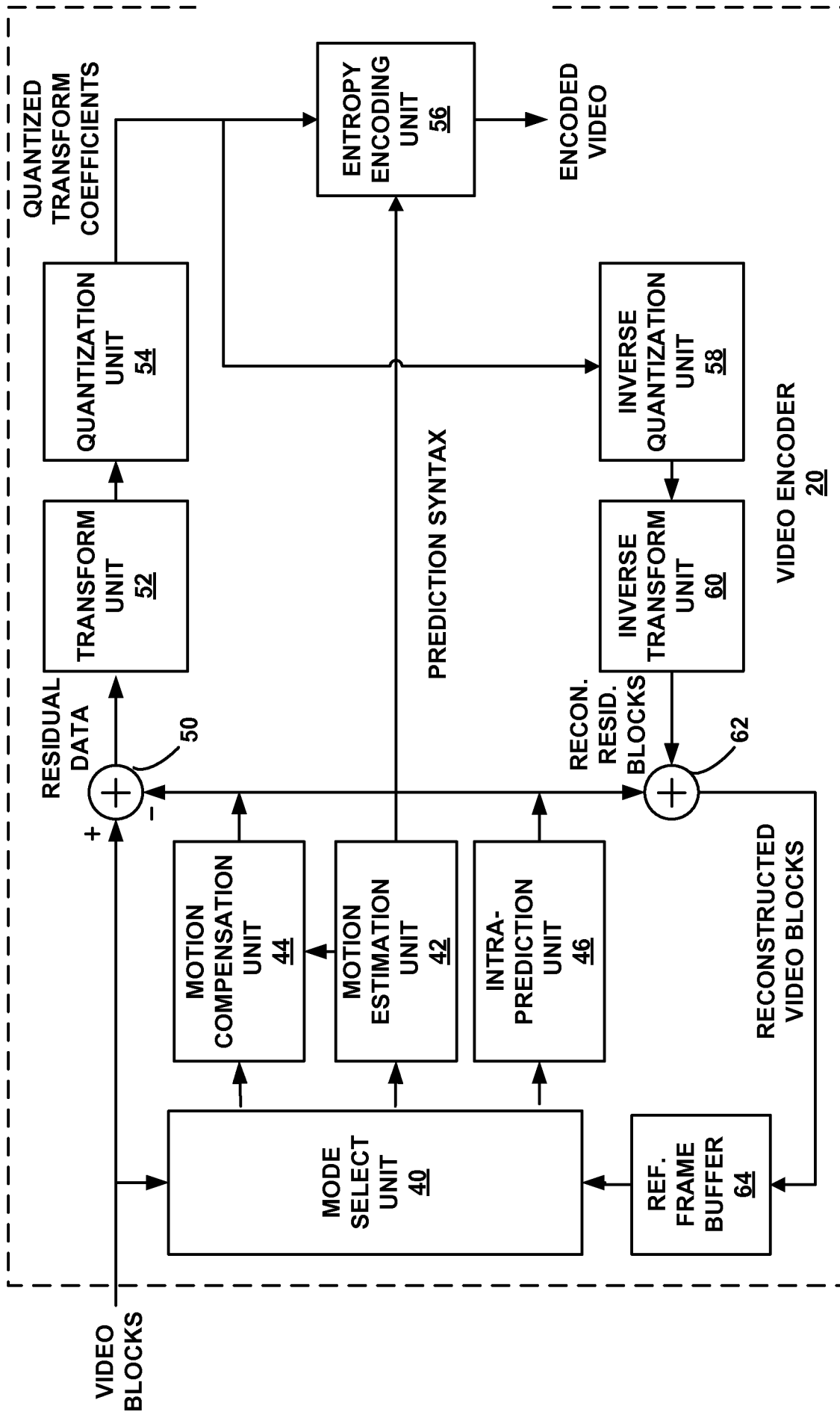

FIG. 12

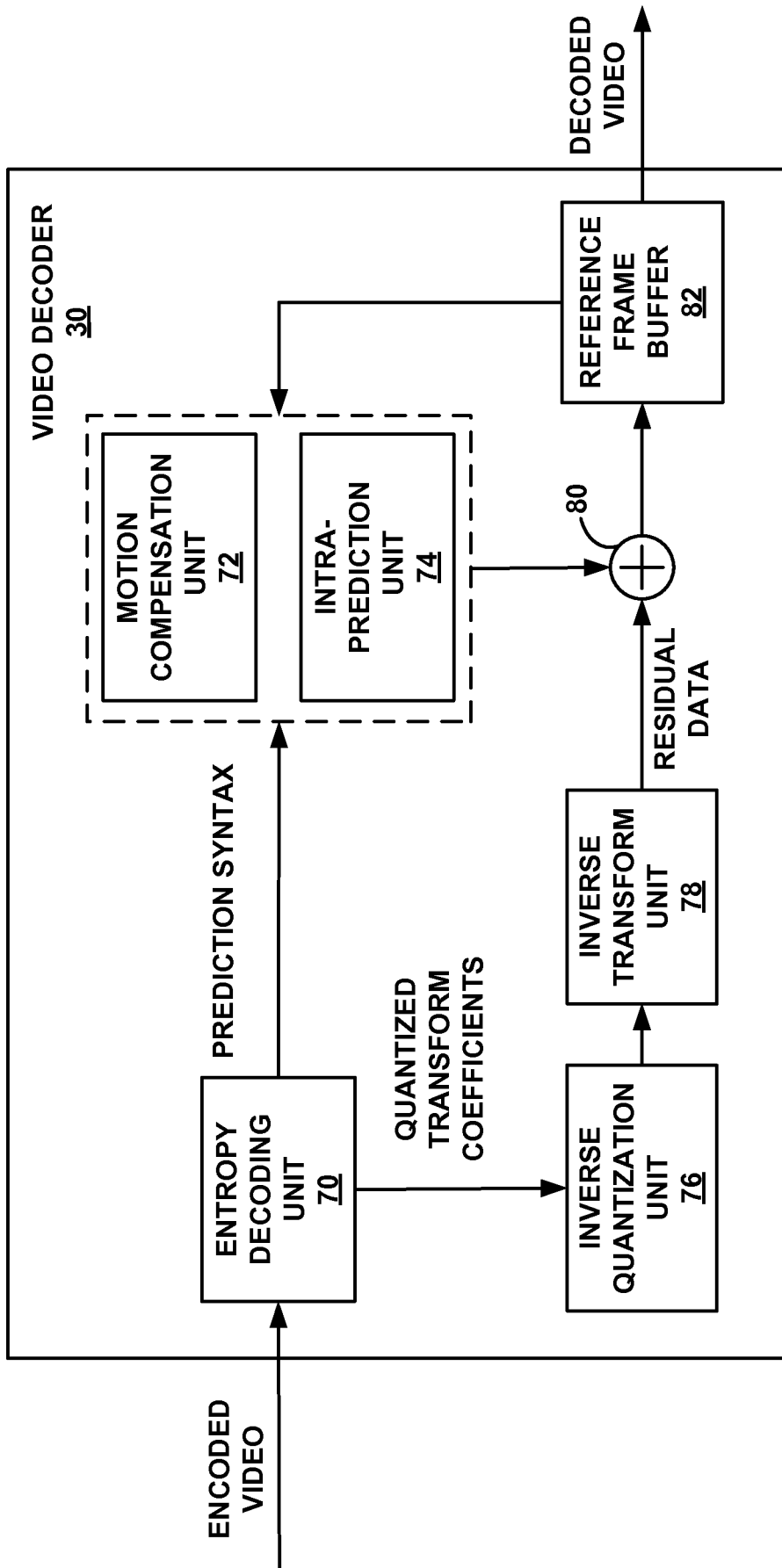

FIG. 13

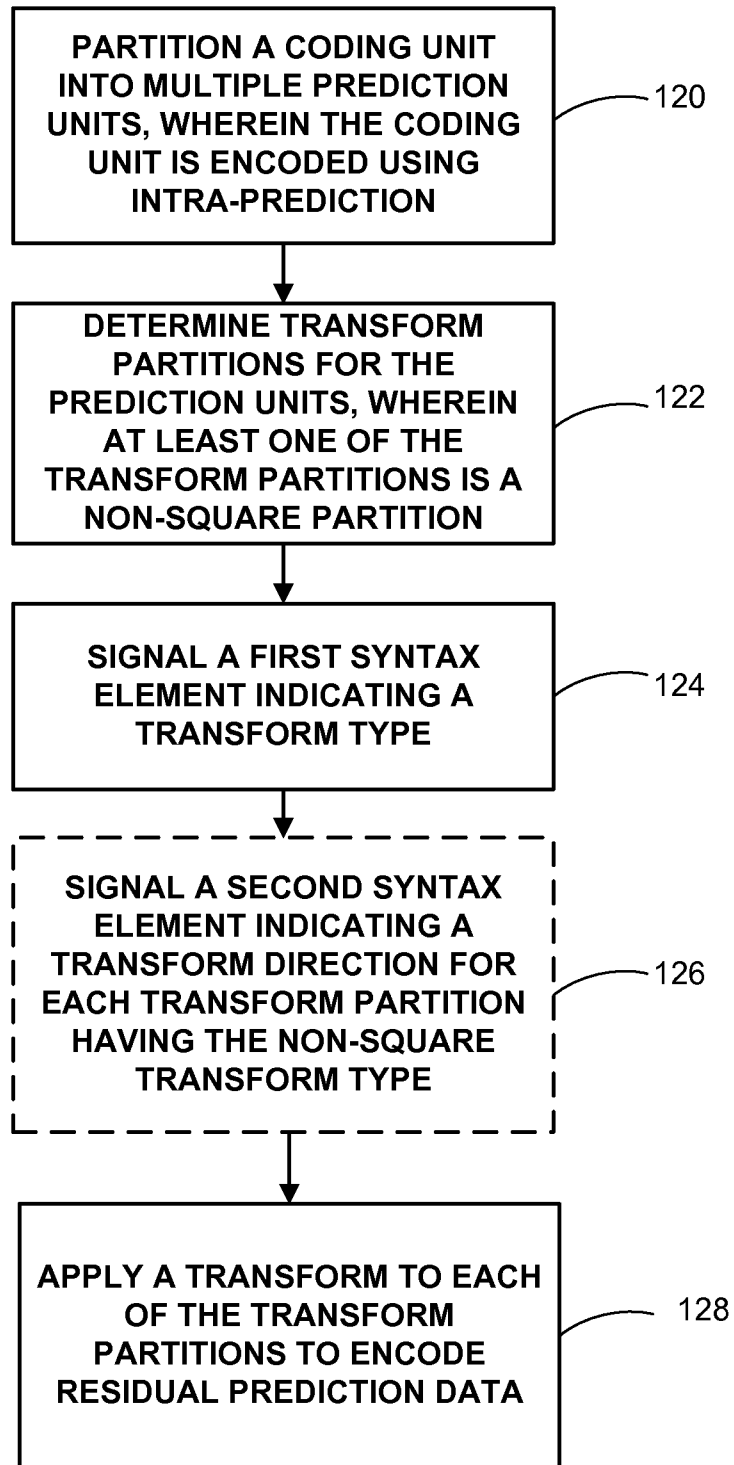

FIG. 14

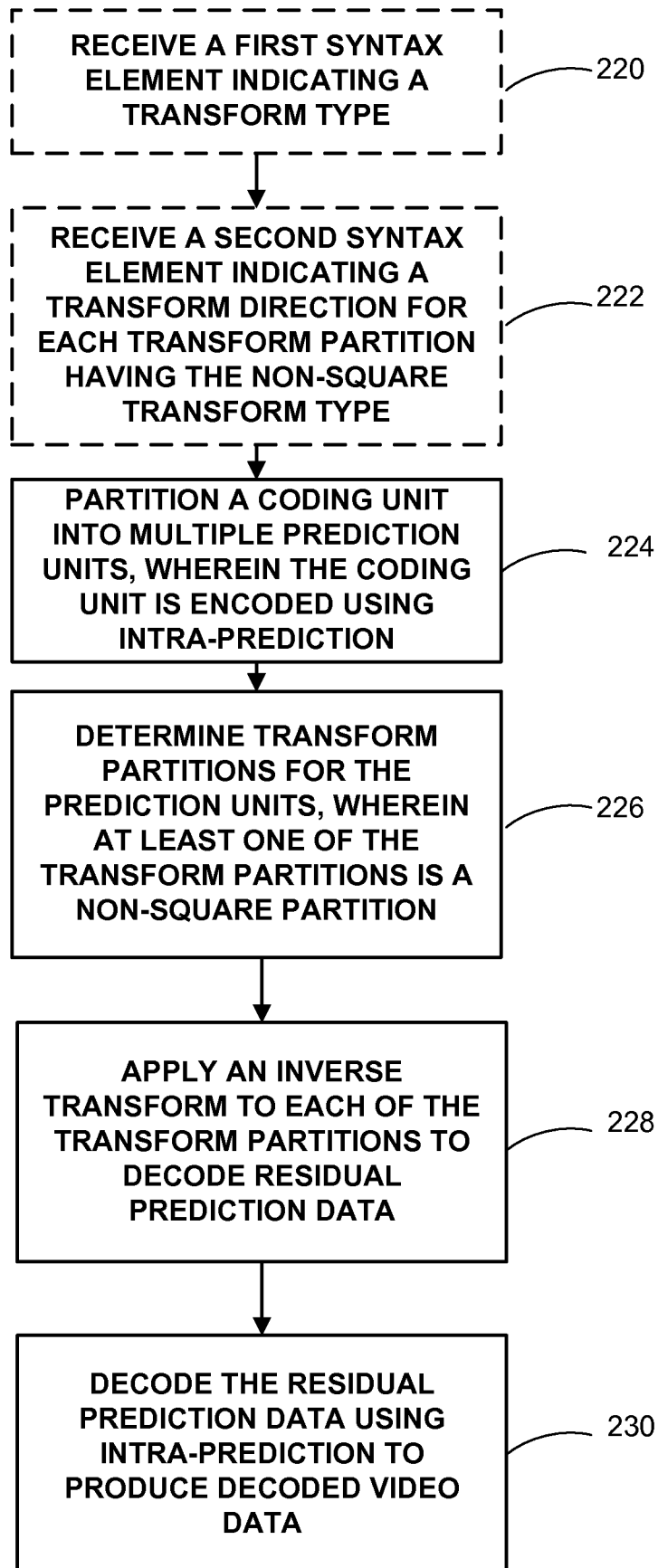

FIG. 15