

[54] TELEPHONE INSTRUMENT

[75] Inventors: James M. Sharp; Daniel H. Christian, both of Corinth, Miss.

[73] Assignee: International Telephone and Telegraph Corporation, New York, N.Y.

[**] Term: 14 Years

[21] Appl. No.: 122,790

[22] Filed: Feb. 19, 1980

[51] Int. Cl. D14-03

[52] U.S. Cl. D14/58; D14/53

[58] Field of Search D14/53, 58, 52; 179/100 R, 100 D, 178, 179, 84 R, 100 C, 91 R

[56] References Cited

U.S. PATENT DOCUMENTS

- D. 236,356 8/1975 Henshaw et al. D14/58
- D. 246,650 12/1977 Peral-Hernandez D14/53
- D. 257,772 1/1981 Fukutani D14/53
- 3,217,254 11/1965 Hughes et al. 179/90 R

Primary Examiner—Bernard Ansher
Attorney, Agent, or Firm—James B. Raden; Marvin M. Chaban

[57] CLAIM

The ornamental design of a telephone instrument, substantially as shown and described.

DESCRIPTION

FIG. 1 is a perspective view of the front of a telephone instrument showing our new design; FIG. 2 is a right side elevational view thereof; FIG. 3 is a front elevational view thereof; FIG. 4 is a left side elevational view thereof; FIG. 5 is a rear elevational view thereof; and FIG. 6 is a perspective view of a further embodiment thereof.

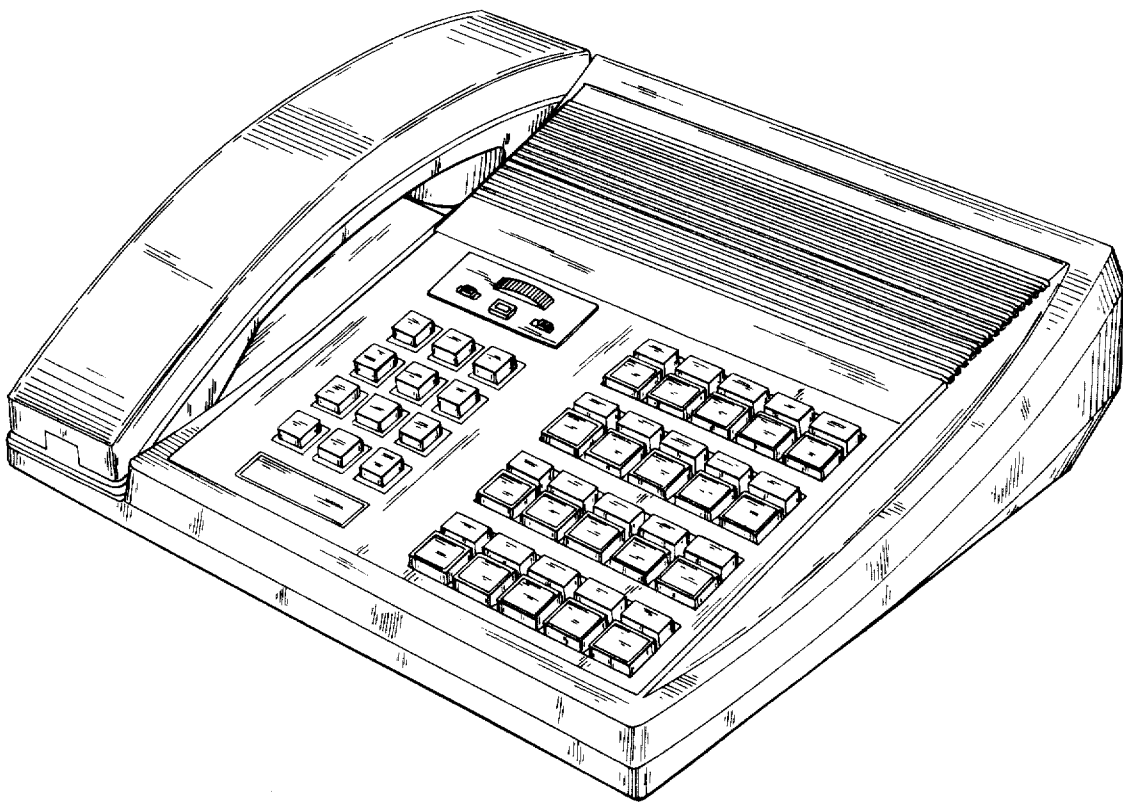

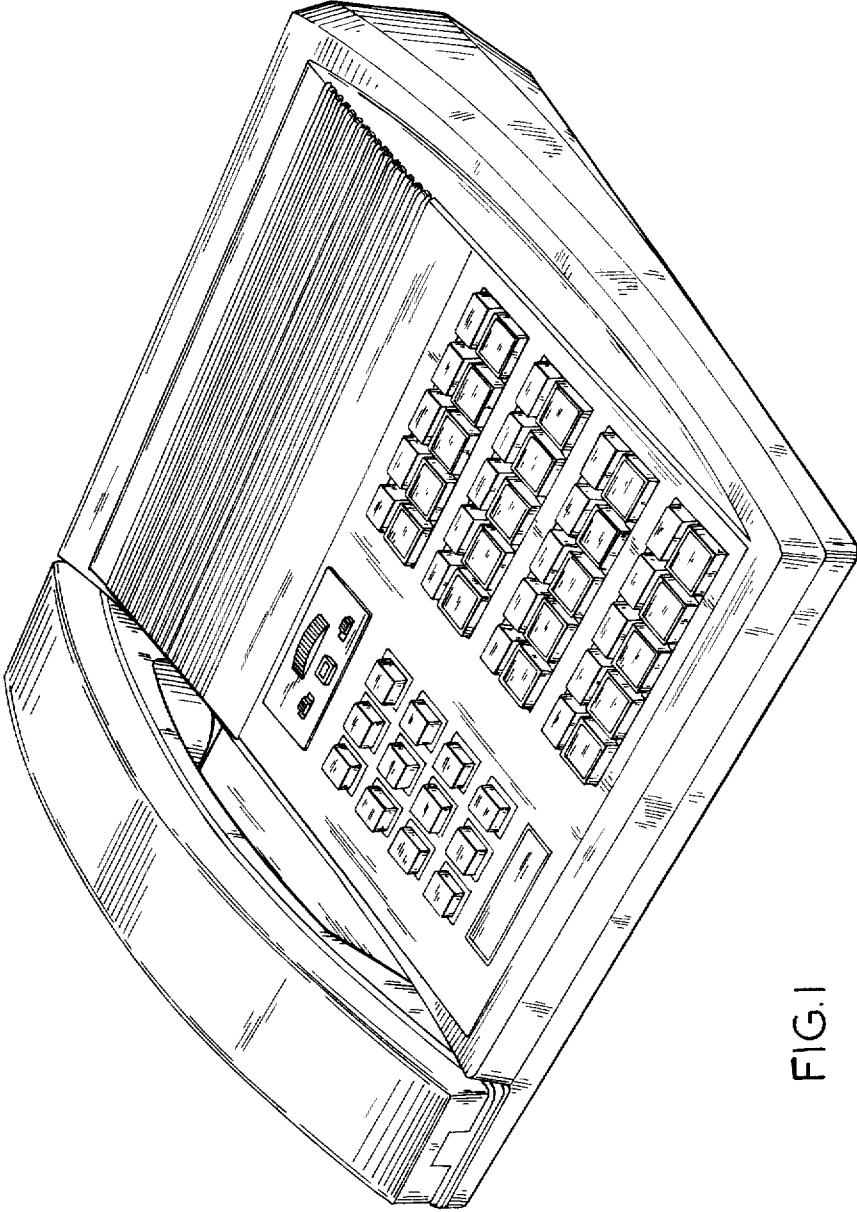

FIG. 1

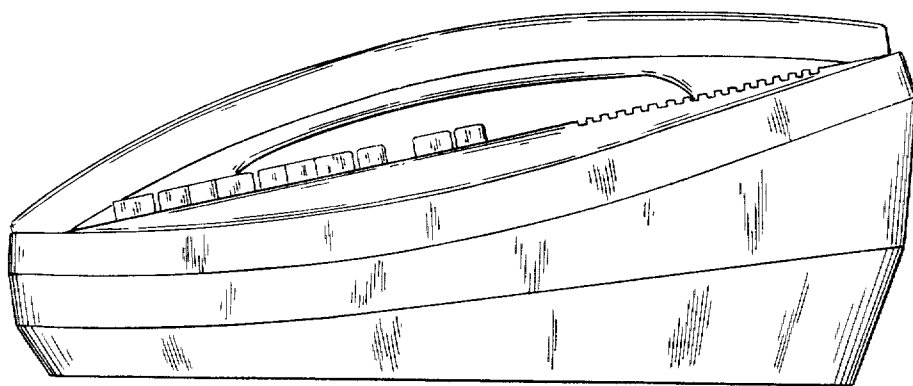

FIG. 2

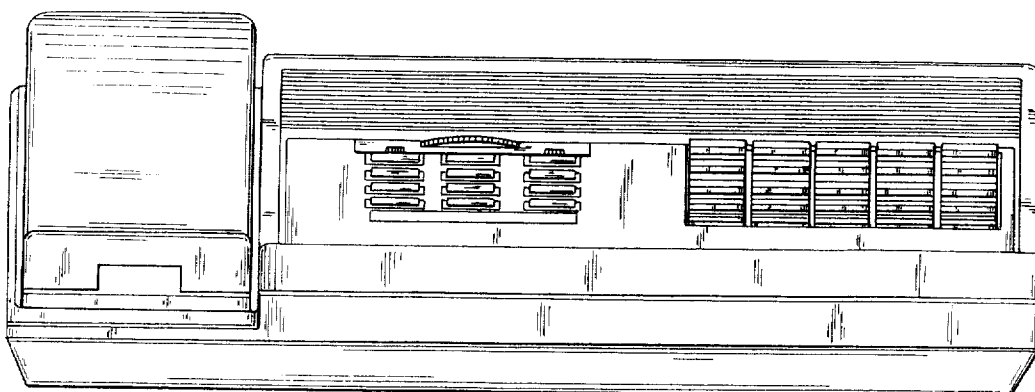

FIG. 3

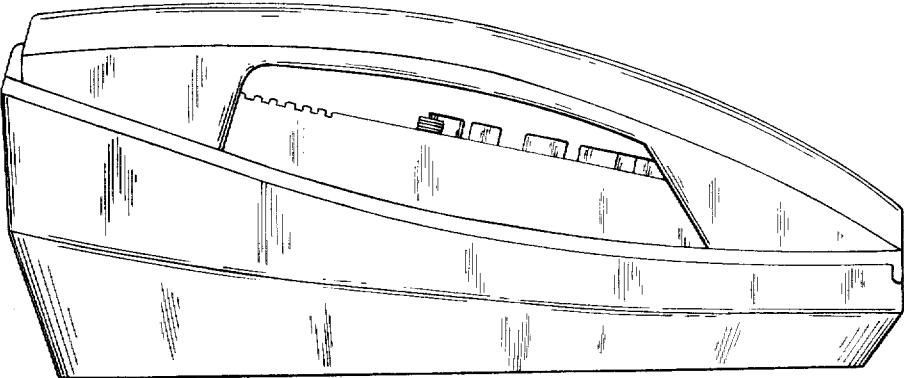

FIG. 4

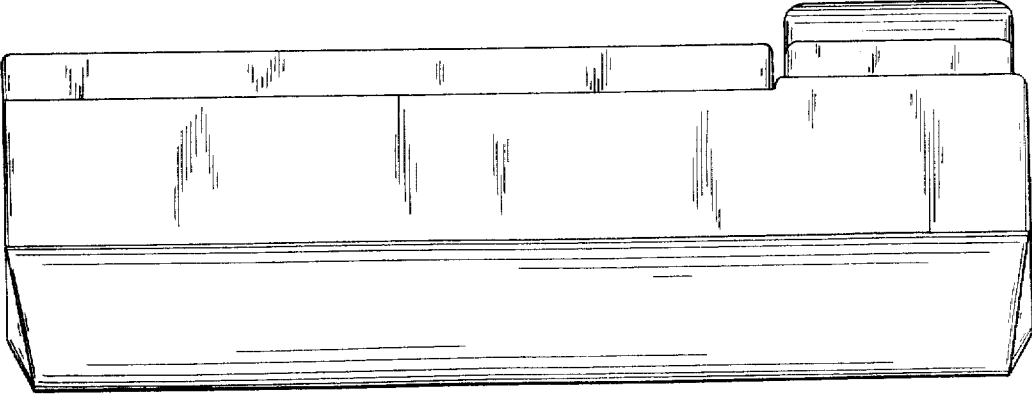

FIG. 5

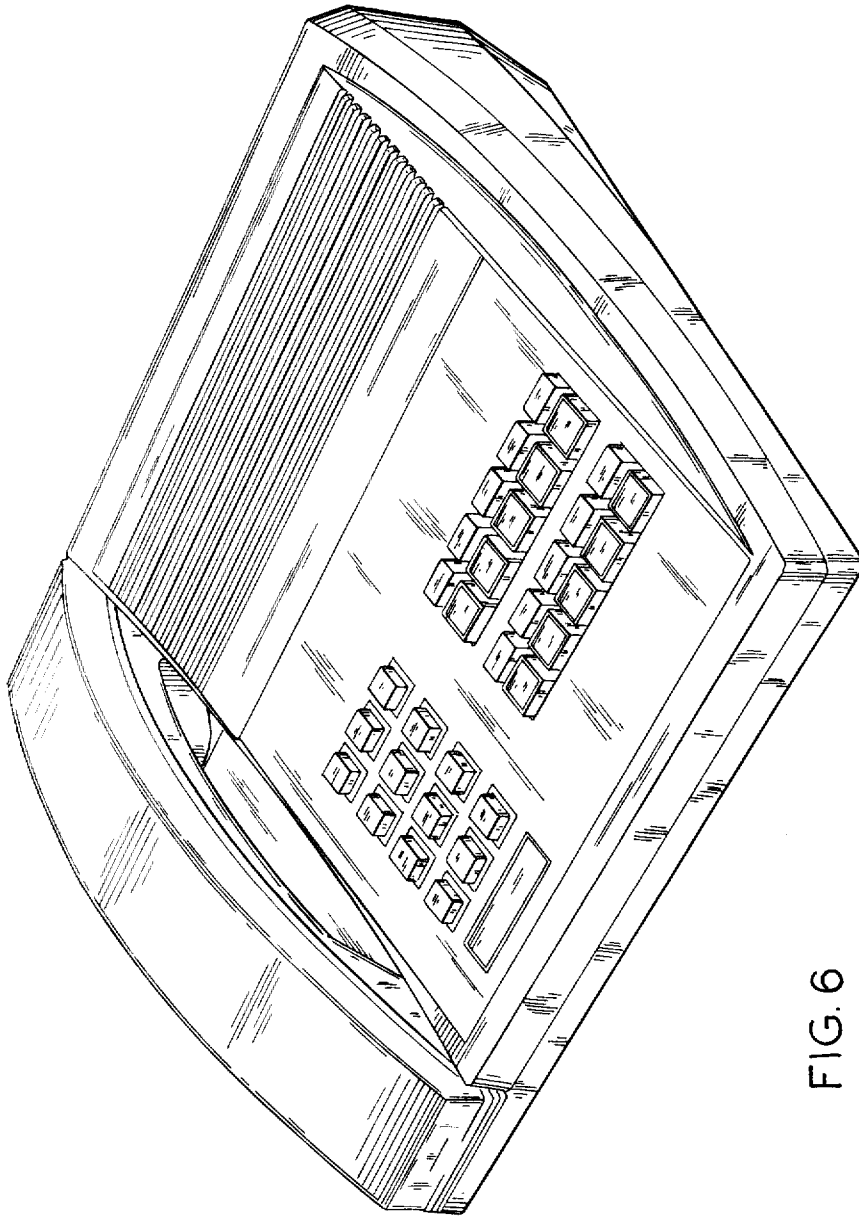

FIG. 6