

(19) World Intellectual Property Organization
International Bureau



(43) International Publication Date
23 May 2002 (23.05.2002)

PCT

(10) International Publication Number
WO 02/41177 A1

(51) International Patent Classification⁷: **G06F 17/30**

(74) Agent: **LLOYD, Barry, George, William**; BT Group Legal Services, Intellectual Property Department, 8th floor, Holborn Centre, 120 Holborn, London EC1N 2TE (GB).

(21) International Application Number: PCT/GB01/05051

(22) International Filing Date:
16 November 2001 (16.11.2001)

(81) Designated States (*national*): AE, AG, AL, AM, AT, AU, AZ, BA, BB, BG, BR, BY, BZ, CA, CH, CN, CO, CR, CU, CZ, DE, DK, DM, DZ, EC, EE, ES, FI, GB, GD, GE, GH, GM, HR, HU, ID, IL, IN, IS, JP, KE, KG, KP, KR, KZ, LC, LK, LR, LS, LT, LU, LV, MA, MD, MG, MK, MN, MW, MX, MZ, NO, NZ, OM, PH, PL, PT, RO, RU, SD, SE, SG, SI, SK, SL, TJ, TM, TR, TT, TZ, UA, UG, US, UZ, VN, YU, ZA, ZW.

(25) Filing Language: English

(26) Publication Language: English

(30) Priority Data:
00310267.0 20 November 2000 (20.11.2000) EP
00310269.6 20 November 2000 (20.11.2000) EP
00310323.1 21 November 2000 (21.11.2000) EP

(84) Designated States (*regional*): ARIPO patent (GH, GM, KE, LS, MW, MZ, SD, SL, SZ, TZ, UG, ZM, ZW), Eurasian patent (AM, AZ, BY, KG, KZ, MD, RU, TJ, TM), European patent (AT, BE, CH, CY, DE, DK, ES, FI, FR, GB, GR, IE, IT, LU, MC, NL, PT, SE, TR), OAPI patent (BF, BJ, CF, CG, CI, CM, GA, GN, GQ, GW, ML, MR, NE, SN, TD, TG).

(71) Applicant (*for all designated States except US*): **BRITISH TELECOMMUNICATIONS PLC** [GB/GB]; 81 Newgate Street, London EC1A 7AJ (GB).

(72) Inventor; and

(75) Inventor/Applicant (*for US only*): **TITMUSS, Richard, John** [GB/GB]; 27 King Edward Road, Ipswich, Suffolk IP3 9AN (GB).

Published:
— with international search report

[Continued on next page]

(54) Title: METHOD OF MANAGING RESOURCES

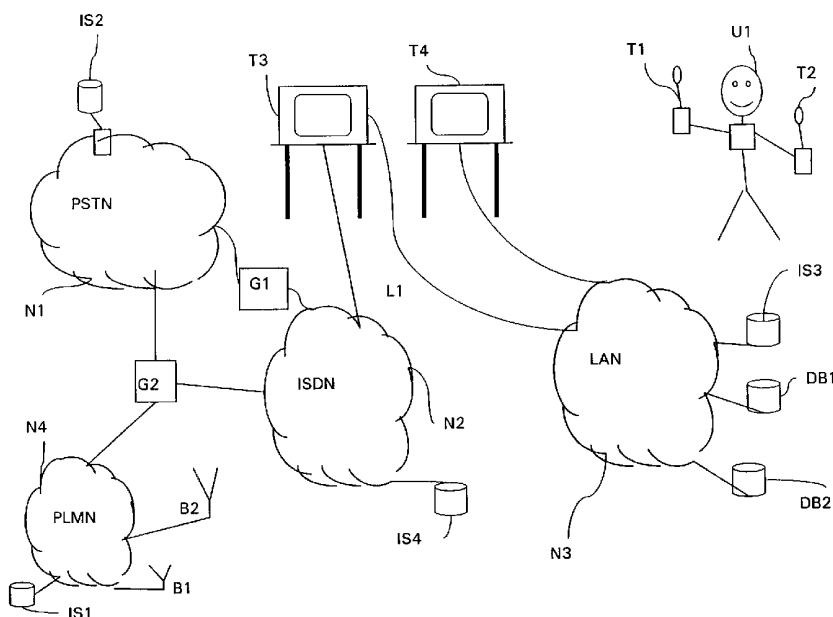

(57) Abstract: The invention is concerned with a method of retrieving information in respect of subject matter of interest to a user on the basis of a state of the user, and of presenting the retrieved information to the user via a terminal, where the presentation of information includes creating a viewable page that comprises at least some of the retrieved information. The method includes the steps of: (i) retrieving information, (ii) organising the retrieved information in accordance with predetermined criteria, at least one of which includes a state of the user, and (iii) storing the organised information, such that when a viewable page is created, a selection of said stored information is retrieved in accordance with display capabilities of the terminal.

WO 02/41177 A1



— *before the expiration of the time limit for amending the claims and to be republished in the event of receipt of amendments*

For two-letter codes and other abbreviations, refer to the "Guidance Notes on Codes and Abbreviations" appearing at the beginning of each regular issue of the PCT Gazette.

METHOD OF MANAGING RESOURCES

The present invention relates to a system and method of managing resources, particularly for managing loadings in distributed information retrieval
5 systems.

In the current information rich climate, a considerable amount of attention is being paid to develop improved methods of information retrieval. In particular, the field of agent technology is heavily involved in developing agents for searching, summarisation, filtering and presentation of information e.g. Davies, Weeks & Revett,
10 1997 (Davies, Weeks, Revett (1997) "Information Agents for the WWW" in Software agents and soft computing, Eds H. Nwana, N. Azarmi, Berlin Springer-Verlag). Most, if not all, of these rely on the agent having some knowledge of the user. The inclusion of user information is rapidly becoming a key area, not only for agent technology, but also for the Internet in general, as demonstrated by the recently
15 proposed Open Profiling Standard Dunn, Gwertzman, Layman & Partovi 1997 (Dunn, Gwertzmann, Layman, Partovi (1997) "Privacy and profiling on the web" Technical note, WWW consortium 2 June 1997). User information is undoubtedly playing an ever-increasing role as digital libraries, electronic commerce, and personalised applications become more widespread.

20 The goal for many workers involved in the design of information retrieval systems is to design a system that can identify information for, and present information to, many users. The amount of processing involved in serving a request for information can be expected to scale with the number of users, as interests generally vary between users. As a result the scalability of a system is likely to
25 become an increasingly important issue with increasing user subscription. Clearly systems that are unable to deliver information to their customers within a reasonable amount of time are likely to lose their customers to systems that can. In general, information retrieval systems comprise a plurality of components: web, database and/or files servers, which pass information between each other in accordance with
30 the architecture of the retrieval system.

One way of reducing network traffic and response times between these components is to employ various caching techniques. Caching is a special high-speed

storage mechanism, whereby data that is repeatedly accessed is stored in a buffer – typically in either static or dynamic memory (conventionally referred to as memory and disc caching respectively) – for quick access. There are many types of caches, notably "macro" caches to which highly popular information can be distributed and periodically updated and from which most users would obtain information; Local server caches (for example, corporate LAN servers or access provider servers that cache frequently accessed files), where the decision of what data to cache may be entirely local; a web browser's cache, which contains the most recent Web files that have been downloaded and which is physically located on the hard disk (and possibly some of the following caches at any moment in time); a disk cache (either a reserved area of RAM or a special hard disk cache) where a copy of the most recently accessed data and adjacent (most likely to be accessed) data is stored for fast access; RAM itself, which can be viewed as a cache for data that is initially loaded in from the hard disk (or other I/O storage systems); L2 cache memory, which is on a separate chip from the microprocessor but faster to access than regular RAM and L1 cache memory on the same chip as the microprocessor.

Furthermore, some personalised information retrieval systems perform pre-emptive caching and filtering, where popular web pages are multicast to regional publication centres to be examined by user agent programs and, possibly, forwarded to a user's home system for viewing. This avoids the problem of network overload since the server at the original publication point will multicast the object to a manageable number of regional centres and this process may be repeated to send the object to sub-centres. It also aids the user in finding new and interesting items since the user will be notified if their personal filtering agent accepts an item.

25

In the following description, the terms "interest", "user profile", "information source", "context", "instantiated interest" are used and are defined as follows: "interest" includes subject-related data such as keywords and/or images and/or music that are representative of a subject. Commonly images and music are accompanied by some form of description e.g. for music "Faure Requiem, written in 1887, the piece reflects Faure's vision of death". In this case, keywords could be extracted from the description, and used to describe an interest (e.g. for the subject Impressionist, Death).

30

"user profile" includes one or more interests stored in respect of a user.

"information source" includes an entity that contains information, e.g. a document.

"context" includes representations that describe the current status of a user – e.g. state (work, play), situation (home, away) and company (colleagues).

5 "instantiated interests" when the status of the user has been identified, the context of the user is instantiated – e.g. the user is identified to be working at home, so the context is instantiated to work, home. Interests are then filtered according to the instantiated context and these interests are referred to as instantiated interests.

10 According to a first aspect of the invention there is provided a method of retrieving information in respect of subject matter of interest to a user on the basis of a state of the user, and of presenting the retrieved information to the user via a terminal, where the presentation of information includes creating a viewable page comprising at least some of the retrieved information. The method includes the steps of:

- 15 (i) retrieving information,
(ii) organising the retrieved information in accordance with predetermined criteria, at least one of which includes a state of the user, and
(iii) storing the organised information,

such that when a viewable page is created, a selection of said stored information is

20 retrieved in accordance with display capabilities of the terminal.

The subject matter of interest includes a plurality of sets of keywords, each set of keywords having at least one identifiable state of the user allocated thereto, and the organising step (ii) comprises

25 tagging the retrieved information in accordance with whichever state was allocated to its corresponding set of keywords,

ranking said tagged information, at least on part, in accordance with a state of the user, and

30 arranging the tagged information in accordance with the rankings associated therewith.

Preferably the method further includes the steps of

identifying duplicates in the tagged information,

removing duplicates so that there is only one of each tagged information, and assigning a predetermined ranking to the tagged information for which there are duplicates. The assigned ranking may have the effect of increasing the ranking of that tagged information, as duplicates can indicate that information is especially relevant to a user, particularly when the information has been retrieved in respect of different subject matter.

According to a second aspect of the present invention there is provided a method of identifying information in respect of subject matter of interest to a user when information has already been retrieved in respect of subject matter of interest to one or more other users. The method includes the steps of:

storing the retrieved information of interest to the or each other user;
comparing the subject matter of interest to the user to the subject matter of interest to the or each other user, and if there is overlap between subject matters;
and
identifying the stored information corresponding to the overlapping subject matter as being relevant to the user.

This second aspect has the effect of reducing the volume of retrieval traffic, as new queries are checked for overlap with queries that have already been serviced; if there is overlap between the queries then there is no point in retrieving the same information more than once.

Further aspects, features and advantages of the present invention will be apparent from the following description of preferred embodiments of the invention, which refers to the accompanying drawings, in which

Figure 1 is a schematic diagram illustrating the physical, or transport, layer of a communications system according to the invention;

Figure 2 is a schematic block diagram showing components of an information provider according to the present invention;

Figure 3 is a schematic block diagram showing means for generating actions by a profiler forming part of the apparatus of the information provider shown in Figure 2;

Figure 4 is a schematic block diagram showing external inputs to a context determining means forming part of the apparatus of the information provider shown in Figure 2;

Figure 5 is a schematic flow diagram showing steps involved in determining a user's context according to the present invention;

Figure 5b is a schematic block diagram showing further external inputs to the context determining means shown in Figure 4;

Figure 6 is a schematic flow diagram showing steps carried out by second retrieving means forming part of the apparatus of the information provider shown in Figure 2;

Figure 7 is a schematic block diagram showing the second retrieving means of the information provider of Figure 2 co-operating with a monitoring means component; and

Figure 8 is a schematic diagram showing a Bayes net forming part of the monitoring means component.

Overview

Referring to Figure 1, at the physical level the communications environment of a user U1 includes a cellular telephone T1 and a personal digital assistant T2 carried by the user; and a computer workstation T3 including a modem. The workstation T3 is most likely to be located some distance away from the user U1.

The workstation T3 in this case comprises a local area network (LAN) server, connected to further terminals (only one shown T4) at different distances from the user. In communication with the various terminals are a number of different communications channels forming parts of different notional networks (although some or all may be commonly owned). The workstation T3 is also connected to database servers DB1, DB2, shown on the same LAN N3 as the terminal T3; it is understood that the database servers DB1, DB2 could be located on LANs that are connected to LAN N3 via one or more switches and/or routers (not shown).

A public switched telephone network (PSTN) N1 is interconnected with an integrated services digital network (ISDN) N2 via a gateway G1 (e.g. a local or international switching centre), and is connected via an ISDN line L1 to terminal T3, and hence to local area network N3. A public land mobile network (PLMN) (e.g. a GSM -

compatible digital cellular network) N4 is connected via a gateway G2 to the PSTN N1 and ISDN N2. A base station B1 of the PLMN provides a Pico cell in the environment of the building within which the user U1 is located, and a base station B2 provides a cell within the same general area. Thus, the networks N1-N4 are capable of delivering data
5 at different rates to the various terminal T1-T3: low speed data via the PLMN N4, higher speed data via the PSTN N1, and yet higher speed data via the ISDN N2 or LAN N3.

Information sources, held for example on servers IS1-IS4, are distributed throughout the networks N1-N4. Only four servers are shown, however other
10 distributions are envisaged. The user U1 wishes to receive pertinent information from any or all the information sources in the system.

Overview of an Information retrieval system that utilises an embodiment of the invention

15 The context of a user U1 at a moment in time largely determines the type and content of information that is of interest to the user U1 at that moment in time, e.g. if a user U1 is at work then the user U1 is likely to want to know about work related interests. If information is categorised and presented according to the user's context, it achieves three things: firstly the volume of information presented to the
20 user U1 is reduced, secondly the user does not have to manually filter out information that is not relevant to his present context, and thirdly the user is not distracted by information that is not relevant to his present context. It is therefore convenient to filter information as a function of a user's context in order to reduce the volume of information that is not relevant to the user.

25 Referring to Figure 2, an information retrieval system that makes use of an embodiment of the present invention, is generally referred to as information provider 200, is located on terminal T3. The information provider 200 essentially comprises a profiler 201 for generating a profile comprising interests of a user, interfacing means 203 for interfacing with the user, Index generator 205 for indexing information
30 sources stored on servers IS1 – IS4, and retrieval engine 207 for retrieving information in accordance with the context of a user.

The components of the information provider 200 are described in greater detail below, but in overview, the profiler 201 receives interests information from the

user, via interfacing means 203, and generates a personal profile, which is stored in profile database DB1, for the user. The interests comprising the profile are accompanied by attributes, e.g. home/away, work/play, which generally describe a context of the user. The Index generator 205, as mentioned above, indexes
5 information sources stored on servers IS1-IS4.

The retrieval engine 207 comprises context-determining means 209, first retrieving means 211 and second retrieving means 213. Context-determining means 209 receives information from external sources relating to the user U1 – e.g. the location of the user, the time of day, and one or more inputs from a diary, from
10 which the context of the user U1 is determined. The first retrieving means 211 is arranged to retrieve information from the personal profile generated by the profiler 201, such that, once the context determining means 209 has determined the context of the user, the first retrieving means 211 can retrieve interests relating to that context. The second retrieving means 213 uses the context-related interests retrieved
15 by the first retrieving means 211 to query the index generator 205 and retrieve information sources corresponding to those queries.

The amount of processing involved in serving a request for information can be expected to scale with the number of users. This is because interests, and the context in which interests are tagged as relevant to a user, generally vary between
20 users, making it difficult to generate a generic query that could be used in respect of multiple users. Furthermore, a system such as the information provider 200 described above involves communication between several components, each of which may be located on separate networks. As a result, each of the processes described above generates network traffic, which, for multiple queries, can result in unacceptable
25 performance levels and ultimately user dissatisfaction.

Essentially embodiments of the present invention are concerned with managing system resources in order to reduce network load and shorten response times. In particular, embodiments cache data as a function of user interests and context. The embodiments are concerned with analysing and caching the results
30 returned by user based pre-emptive caching and filtering systems such as those described above. Thus information that has been identified as being relevant to the user can be organised into a list in accordance with the user's instantiated context, processed for duplicates and then cached. Such caching is particularly advantageous

when presenting information on mobile devices, where the size of the display only allows a subset of information to be displayed to the user at any one time, and the user wants to be presented with information that is most pertinent to him. In embodiments of the invention, sequential subsets of information are extracted from
5 the cache so that the first subset comprises information that would be most relevant to the user's state, and the last subset would comprise information that is least relevant to the user's state.

Further advantages include a lower processing load, as all of the results of user based pre-emptive filtering are analysed "once only", rather than on a "per
10 page" basis. In addition, processing the results "once only" allows duplicates to be identified, possibly for special treatment, and ensures that the user is not presented with the same information twice.

The following worked example illustrates the functionality of the information provider
15 200:

Assume that the user has a user profile including the following sets of interests:

- Mobile Internet (Work)
- WAP (Work, Play)
- Venture Capitalist (Work)
- 20 Motorised transport (Work, Home)
- Television listings (Home, Play)
- Birdwatching (Play)
- Eating out (expensive food) (Play)
- Football – Startreck United (Play)
- 25 Tattingstone White Horse (Play, Home)

At 08:00, while en route for work, the user U1 receives an SMS alert informing him of local traffic delays around Martlesham. The user ignores the report, continues to work and gets stuck in a traffic jam. Bored, the user U1 decides to look
30 at the news available from the information provider 200 on his WAP phone. The user scrolls through the shortlist delivered by second retrieving means 213 and marks those interests that he wants to read later. By default the user U1 was shown work-

related interests, because context-determining means 209 had determined the user's context to be work. However, there are links to Leisure-related interests.

The user U1 has a meeting scheduled with a venture capitalist for 09:00. The user U1 has set a high preference value for information relating to the a venture
5 capitalist interest, so the shortlist includes information relating to a venture capitalist at the top of the list. Fortunately a description of a news article relating to a venture capitalist appears on the shortlist, and the user U1 is able to view the article prior to his 09:00 meeting.

Later in the day, while at his desk and a little bored, the user U1 starts
10 thinking about his evening activities. The user U1 changes the context to the Play/Home context, and is presented with a shortlist of items including TV programmes for that evening, news about his football team, and notice of the next Bird watching convention.

At the weekend, the user U1 visits Norwich. From the user's banking details,
15 the profiler 201 has included an interest in locations of NatWest cash machines, and from the user's motorised transport interest, the profiler 201 has included an interest in locations of petrol stations. Both of these implied interests are appended with all contexts (so in this embodiment Work, Home, Play, Away). The context determining means 209 determines that the context of the user is Away and Play, and, based on
20 the user's determined location by tracking device 405, the second retrieving means 213 retrieves information detailing the location of expensive restaurants, NatWest cash points and petrol stations around Norwich.

Profiler 201

25 The information provider 200 has a predetermined, finite number of interests from which interests associated with a user U1 can be selected. These interests fall within the following non-exhaustive list of categories:

- General interests: e.g. current affairs, finance, home, business, leisure, hobbies, clubs etc.;
- 30 • Places: e.g. home town, holiday destination, business trip, family homes etc.

There is a "master copy" of general interests, which are interconnected via connectors as an acyclic graph. The master copy is stored in a database table in the profile database DB1. Each of the interests (of type general or location) has one or

more predefined keywords that are associated with the interest, and these keywords are also stored within the profile database DB1, linked to their respective interest. (The keywords are used for retrieval of information relevant to the user, as described in more detail later). Each interest has a unique identifier (ID), and the connectors in
5 the acyclic graph link interests together (so that the inclusion of keywords for an interest is at least partly dependent on which other interests are linked to that interest such that, for example, interest I1 inherits a predetermined number of keywords from its parent and child interests).

The profiler 201 is arranged to receive interest information from the user and
10 to generate a profile that comprises the user's interests and keywords relating to those interests. The profiler 201 can also implicitly identify interests in accordance with predefined rules.

Explicit modification of profile:

A user can explicitly input words and/or phrases that are representative of
15 the user's interests, whereupon the profiler 201 attempts to find interests within the master copy that match the input. This involves searching through the acyclic graph for a match between the input and the interests, possibly using WORDNET, a lexical reference system, or similar, to broaden the search. If the profiler 201 cannot locate an interest that matches the input, the user U1 can navigate through the interests
20 and select interests manually.

The profiler 201 can additionally co-operate with a parser (not shown) in order to translate the entered keywords and/or phrases into one or more predetermined interests; many known systems could be adapted to parse input and translate the parsed input into a format understood by the profiler 201.

25 In addition, users can access their profile at all times. Thus a user is able to view their profile, view their instantiated context, make changes directly to their profile, and indeed to the information sources used to retrieve information in respect of the interests in the profile.

30 *Implicit modification of profile:*

The profiler 201 can include one or more rules that inter-relate interests, such that if interest A is linked with interest B and a user U1 has interest A, then the profiler 201 will automatically include interest B in the user's profile. Rules can also

be based on information retrieved by the profiler 201 from other users and/or external sources. The latter can be particularly useful for providing service-related information to users – e.g. if one of the information sources IS1 – IS4 includes information relating to banks, the information provider 200 has the potential to deliver bank-related information to a user. However, in order to deliver bank-related information that is relevant to the user, the information provider 200 needs to know which bank the user U1 has an account with. Clearly the user U1 could explicitly enter this information, but it would be far more convenient to the user U1 if this information could be retrieved without having to involve the user U1 directly. To this end the profiler 201 can be further arranged to co-operate with web browsers (not shown), one located on each terminal T1, T2, T4 used by the user U1. In particular the profiler 201 could download software, for website tracking, on the hard disk drive of the terminal(s) T1, T2, T4. Assuming the user U1 banks “on-line”, the URL of the user’s bank could be accessible to the downloaded software, and from this the profiler 201 can retrieve the name of the bank, and add this to the user profile in the profile database DB1. Alternatively, if the profiler 201 has access to billing information in respect of third party services and/or systems used by the user, the profiler 201 can be arranged to request bank details from the billing system relating to the third party. The third party system could be located on one of the networks N1 – N4.

The user U1 can override any interests that have been inferred implicitly.

The profiler 201 is arranged to tag a context type to each interest. In this embodiment, two categories of context are described, namely state and situation, although many other context categories are possible. In their simplest forms, these context categories have two types: state context has *work* and *play*, and situation context has *home* and *away*. For each category of context, some interests may be tagged with both types of contexts – e.g. user U1 may be interested in computers for Work and Play purposes. The context type can be entered explicitly or implicitly, and each interest can be tagged with a default context type.

30 *Storage of profile*

When an interest is selected for a user U1, the profiler 201 enters an identifier corresponding to the ID of that interest, together with the position of that interest in the tree hierarchy, into a database table for the user U1. The processes

involved in storing data in, performing queries on and receiving data from, databases are known to those with ordinary skill in the art of database administration. For place names interests, e.g. place names in the UK, there is a "master copy" of place names, each of which is accompanied by county information, and an interest in
5 respect of a place name is dynamically created using country/county/place retrieved from the master copy.

Interests can additionally be stored with attributes such as stock value and location. Setting the stock value attribute indicates that the user U1 is interested in stock values in respect of a particular interest (e.g. interest may be a company).
10 Setting the location attribute indicates that the user U1 is interested in location information relating to an interest (e.g. interest may be banks, so that specifying a location attribute, such as Bognor Regis, refines the interest to banks in Bognor Regis). Other attributes include expertise, privacy, relevance weightings, priority weightings, times, days, volume of information, delivery channels, layout, quality of
15 information sources, and bookmarks. There are default settings for each of the attributes, but the user U1 can change any of these settings via interfacing means 203 (described below).

The profiler 201 can also "push" questions out to the user U1 - e.g. to
20 suggest interests to the user in accordance with predetermined rules. The predetermined rules include implicit profiling information, changes in the interest acyclic graph, information from the system administrator, and feedback from the user U1. The profiler 201 monitors the user's response to the questions, and modifies the rules in accordance with the response.

25 Referring to Figure 3, the profiler 201 therefore additionally comprises profile modifier 301 for receiving information from a variety of inputs 302 (e.g. output of collaborative filtering, changes to system interests etc., or feedback from the user U1) and creating actions 305 based on these inputs 302. The inputs may be accompanied by conditions such as time to push information to the user U1, priority
30 status relating to type of interests etc. The profile modifier 301 has access to a predetermined list of functions, and based on the nature of the input 302 and corresponding conditions, selects one of the functions to create an action 305. The functions stored in the list include "user interaction functions", which include the

functionality to activate suggestions and questions to prompt the user U1 with (qualified by question type), and "system functions" in respect of interests, which include the functionality to add new interests, delete referred interests, modify referred interests etc. The "user interaction functions" include pushing information to the user via interfacing means 203, and can be tagged with question type, including "on trial", and "revert to original settings" etc., and delivered to the user in accordance with the priority of the request. The "system functions" include effecting a change to a stored user's profile. This further functionality of the profiler 201 is illustrated in the following example:

10 An interest I1 is passed to the profile modifier 301 as a result of collaborative filtering of interests between users. The profile modifier 301 creates a suggestion action 305, the suggestion being that new interest I1 should be added to the user's profile, and, because the interest is a new interest, profile modifier 301 assigns a condition of low priority to the suggestion. The suggestion action 305 is then pushed to the user U1. Typically a new interest will also be tagged with "on trial", such that the message pushed to the user U1 reads:

"We think that you may be interested in adding a new interest I1 to your profile.

This will have the effect of returning stories like Story1, Story2, Story3

Would you like to add I1 to your profile? Please answer Yes, No, I'll try it for a week"

20 Profile modifier 301 is also operable to receive responses from the user U1. If the user selects the option "I'll try it for a week", a message is sent to the profile modifier 301, which identifies the type of feedback, stores the message and creates a timer condition in respect of an action to prompt for some user feedback. Once the timer has expired, profile modifier 301 generates a feedback action 305 for feedback, kills the timer and deletes the message from the profile modifier 301. The message pushed to the user reads:

"Last week RF suggested the addition of interest I1 to your profile.

Would you like to keep this change?

Please answer Yes or No

30 *(If you answer No you will revert back to your original settings)"*

The feedback from the user U1 is received by profile modifier 301, which identifies the type of feedback. If the feedback includes making a change to the user profile, a system action 305 is generated based on the system functions and the profile is modified as described above.

Other inputs 302 include system administrator inputs – e.g. the user U1 should be questioned in respect of the make of car that the user U1 drives.

The profile modifier 301 further includes means for storing feedback (not shown) from the user U1, in particular maintaining lists of interests in which the user U1 is not interested (on a list of deleted interests). Thus whenever an input 302 is received in respect of a new interest, profile modifier 301 compares the new interest with the list of deleted interests (and does not create an action in respect of deleted interests). In addition to strict comparison between incoming inputs 302 and deleted interests, the profile modifier 301 can access the lexicon WORDNET, or similar, in respect of the interests on the deleted list, comparing new requests with terms identified by WORDNET as being equivalent to deleted interests.

Interfacing means 203

Interfacing means 203 controls the communication of information between the user U1 and the information provider 200. As shown in Figure 1, the user U1 can, for example, communicate with the information provider 200 located on terminal T3 via any one of three Terminals T1, T2, and T4. Two of the Terminals T1, T2 can be arranged to send and receive data using WML (Terminals T1 and T2 having a Bluetooth emitting and receiving device respectively so that information that is received via terminal T1 can be received on terminal T2), and the third terminal T4 can be arranged to send and receive data using HTML. Each of the terminals T1, T2, T4 is capable of running web browsers. The user enters data via a form on the browser, in a known manner, in order to perform a number of actions, including (non-exhaustive list):

- modifying interests comprising the user profile;
- modifying the user's context;
- viewing items pushed to the user; and
- selecting items pushed to the user.

This form essentially captures any parameters entered by a user and transfers the captured parameters to other parts of the information provider 200 stored on the Terminal T3. For further information see "Client/Server Programming with Java and Corba", 2nd Edition, R. Orfali and D, Harkey, pp. 239 - 242.

When the user U1 explicitly adds or deletes an interest from the user profile, the form posts the interests, together with the action that is to be performed in respect of that interest (e.g. add, delete), to the profiler 201, which processes this information as described above. The form can include drop down menus and the like
5 to enable a user U1 to select from a predetermined list, which is especially useful for defining interests in films, food, etc. as the user U1 can select which film he is interested in, or type of food he is interested in.

Interfacing means 203 can alternatively or additionally be configured with means (not shown) to present at least part of the shortlist and/or interactions with
10 the user U1 via a speech medium.

Index generator 205

Index generator 205 creates an index for each information source stored on information source servers IS1 – IS4, and stores the information in index tables on
15 index database DB2. Each index table includes at least some of the following information:

1. The name of information source (e.g. name of a document).
2. Key terms that have been extracted from the information source.
3. The network address (URL) of the information source.
- 20 4. A locality record for the information source
5. Date and time that the information source was created.
6. Context attribute of information source – i.e. whether relevant to Work, Play, Home or Away (optional).

A locality record is a location defined in latitude, longitude and altitude, and a
25 three-dimensional shape defining the locality in which the record is valid, with the defined location at the centre of three-dimensional shape. Localities with which respective information sources are associated are individually configurable. Some information (for example weather information) could therefore be readily accessible by the user over a relatively wide area, whereas other information, being more location-
30 specific (such as local services information), could be filtered out for all areas except in a narrowly defined locality.

The type of information indexed by Index generator 205 includes News data, stock market listings, Lycos, weather data, classified advertisements, event guides,

entertainment information such as cinema listings, places to stay, places to eat, sport, financial information, shopping information e.g. store guides, and information on services e.g. cash point locations, petrol station locations. There are many methods for building indexes to unstructured information sources, and the particular
5 method employed is unimportant for this embodiment. Thus, any means that is capable of retrieving and storing data in accordance with the index table defined above can be used (see "Managing Gigabytes" by Ian H. Witten, Alistair Moffat, Timothy C. Bell Morgan Kaufmann; ISBN: 1558605703 for a comprehensive review of many methods currently employed in search and retrieval technology). The Index
10 generator 205 accesses the information servers IS1 – IS4 at regular intervals so that the index tables are up to date (daily, hourly, weekly, depending on the nature of the information source and the rate at which it changes).

Retrieval engine 207

15 The function of retrieval engine 207 is to determine and instantiate the user's context in real-time, to retrieve interests associated with the instantiated context from the profiler 201 and to retrieve information from information sources IS1 – IS4 via Index generator 205 based on those interests.

The first stage – in which the retrieval engine 207 determines and
20 instantiates the user's context – is performed by context-determining means 209 and is described with reference to Figure 4. Context-determining means 209 includes a configurable list 400 defining each of the context types – e.g. HOME can be defined by a location – as latitude and longitude values, and AWAY can be defined as any location more than n1 Km from home. Similarly, WORK can be defined by time of day
25 and location, and PLAY can be defined by time of day and any location more than n2 Km from work. The Context-determining means 209 is arranged to receive input from several sources, e.g. a diary 401, a clock 403, and a personal tracking device 405, and to combine these inputs with information in the predetermined list so as to derive the context of the user U1. The examples shown in Figure 4 are merely illustrative of
30 the types of sources that can co-operate with Context-determining means 209 (more examples are given below).

The clock 403 could be a system clock, located on the Terminal T3. The diary 401 could be Microsoft Outlook™ calendar, or a custom built diary, to which the

Context-determining means 209 can submit queries at predetermined times, requesting time-tagged data in respect of the user's planned actions. Information relating to interfacing with Outlook™ can be found in "Programming Microsoft Outlook and Microsoft Exchange" by Thomas Rizzo, Microsoft Press; ISBN: 5 0735605092. Entries in a diary 401 often include phrases, which require to be parsed into a format recognised by the Context-determining means 209; the diary 401 can be configured to interact with a parser and translate the entries accordingly.

The personal tracking device 405 is carried by the user U1 and enables his position within the communications environment to be tracked. For example, in this 10 embodiment the tracking device 405 comprises a chip carrying card or "smart card" carrying data identifying the user, and some or all of the terminals T1-T5 carrying a card reader are arranged to read the card. Alternatively, it could comprise a 'smart badge' transponder, the location of which is tracked within the building. Specifically, the workstations T1-T4 and the cellular telephone T1 carry such smart card readers. 15 Additional smart card readers are installed at access doors within the building, and are connected to the LAN N3 to signal thereon. Further, preferably, the cell phone T1 comprises, in addition to cell phone communicating components, a global positioning system (GPS) receiver and is arranged to derive and signal its position periodically as disclosed in EP 0467651 (Motorola). Alternatively, the cell phone T1 could perform 20 positioning additionally using a land-based positioning signal, such as by differential GPS positioning, or purely using land-based positioning signals, such as differential GSM triangulation signals.

Once the Context-determining means 209 has gathered information from the diary 401, the clock 403 and the tracking device 405, and other such devices (not 25 shown), this information is combined in order to instantiate the user's context. As an example, this process is defined with reference to Figure 5:

- S 5.1 Take current time (t) and compare with time slots predefined for work (start time T₁, end time T₂, nominally applies to weekdays):
 - i. If (T₁ < t < T₂) and diary information work related: context WORK
 - 30 ii. If (T₁ < t < T₂) and diary information play related: context PLAY (e.g. day on leave)
 - iii. If (t < T₁ OR t > T₂) and diary information work related: context WORK (e.g. working in evening)

iv. If $(t < T_1 \text{ OR } t > T_2)$ and diary information play related: context PLAY (i.e. evening free)

- S 5.2 Transform position data (l_i, l_j) into latitude and longitude and compare with position for home (loc_1, loc_2) :

- 5 (i) If $(loc_1 < l_i < loc_1 + n_1)$ AND $(loc_2 < l_j < loc_2 + n_1)$: context HOME
 (ii) If $(l_i > loc_1 + n_1)$ OR $(l_j > loc_2 + n_1)$: context AWAY

such that

S 5.1 (i or iii) and S 5.2 (i) give WORK, HOME (W, H) as contexts

S 5.1 (i or iii) and S 5.2 (ii) give WORK, AWAY (W, A) as contexts

10 S 5.1 (ii or iv) and S 5.2 (i) give PLAY, HOME (P, H) as contexts

S 5.1 (ii or iv) and S 5.2 (ii) give PLAY, AWAY (P, A) as contexts

In addition to instantiating the context of the user with respect to state and situation, additional context information can be determined, for example, "outside", "stressed", "engaged", etc. Inputs from the devices listed at points 1 – 7 below, some of which are shown in Figure 5b, may be used to identify this additional context information. Such additional context information can also be used to determine whether or not to push information to the user, as described in more detail below. The devices may include:

1. Information from the user: the user U1 can use a predetermined key, or sequence of keys, to indicate that he is distracted or on the move via terminal T1;
2. Weather information;
3. Light level detectors, such as Photovoltaic sensing devices available from Remote Measurement Systems 2633 Eastlake Ave E, Suite 20, Seattle WA 98102 (e.g. PVC-1 device)
- 25 4. Thermocouple sensors, such as temperature indicators available from TC Ltd (TC Ltd, P.O. Box 130, UXBRIDGE UB8 2YS, England) – to help determine whether the user U1 is outside or inside;
5. Input representative of stress levels – e.g. monitoring body temperature or interactions of the user with his terminal T1, T2, T4. Monitoring of user/terminal interaction is disclosed in the Applicant's published application W000/25565 (IPD case ref A25709);
- 30 6. Input representative of Noise levels – can be determined by analysing the audio signal received via the audio input on the terminal T1;

7. Inputs from additional physical sensors, connected to the terminal T1 by a serial interface (not shown), including inputs from
- a low acceleration detector 501 (e.g. ADXL202, which measures acceleration of a low force in two directions);
 - 5 ○ a high acceleration detector 503 (ACH04-08-05 available from Measurement Specialities Incorporated (which can be referenced via Universal Resource Locator (URL) <http://www.msiusa.com> on the Internet)) which measures acceleration of a high force in three directions;
 - a direction detector 505 (e.g. a compass, HMC2003, available from
10 Honeywell (referenced via URL <http://www.ssechoneywell.com>), which gives an absolute measurement of orientation of the terminal T1); and
 - a direction and velocity detector 507 (using an ENC Piezoelectric Vibrating Gyroscope (part number S42E-2 which is sold under the registered trademark GYROSTAR) available from Murata manufacturing Company Ltd.
15 (URL <http://www.murata.com>)). The acceleration, direction and velocity detectors may be connected via a multiplexer 509 (MUX) to the context-determining means 213.

The complex nature of the physical data makes the use of simple rules for determining the user's context from all of these inputs unreliable. Hidden Markov
20 Models (HMM), or a Kalman Filter, can be used to determine more accurately the user's context when the instantiation of context is based on a combination of inputs 1 – 7. A good description of the mechanics and applications of Kalman Filters is provided by du Plessis, R.M., 1967; *"Poor man's explanation of Kalman Filters or How I stopped worrying and learned to love matrix inversion"*.

25

The second stage – in which the retrieval engine 207 retrieves interests associated with this instantiated context from the profiler 201 – is performed by first retrieving means 211, which submits a request in respect of the instantiated context to the profiler 201. The profiler 201 queries the profile database DB1, which retrieves
30 information in accordance with the query, and returns interests relating to the instantiated context to the first retrieving means 211. For example, if the instantiated context is Work, Play, the database DB1 searches for interests tagged with W, P.

The third stage – in which the retrieval engine 207 retrieves information relevant to the user's instantiated interests from information sources IS1 – IS4 – is performed by second retrieving means 213, as shown in Figure 6.

Second retrieving means 213:

- 5
- S 6.1 Receives the instantiated interest data from first retrieving means 211;
 - S 6.2 Selects one of the index tables containing data relating to an information source, and checks for correspondence between instantiated interests and indexed keywords, e.g. using a key word match;
 - S 6.3 Retrieves network address (URL) and name of information source for positive
- 10
- key word matches;
 - S 6.4 Repeats S 6.2 and S 6.3 for all of the information sources that have been indexed by Index generator 205;
 - S 6.5 Compiles network address (URL) and name of the information sources that have been retrieved at S 6.3 into items on a shortlist.

15

In an alternative embodiment, first retrieving means 211 retrieves *all* of the user's interests. Then, using the context attributes tagged to the interests, e.g. football P (Play), H (Play, Home); computers W, P (Work, Play), second retrieving means 213 ranks the items on the shortlist in accordance with the user's instantiated context. In addition, any items that occur more than once (duplicate items that have been returned

20

in respect of two different interests) can be assigned a higher ranking. The items on the shortlist created at S 6.4 are then organised in accordance with the rankings, so that items that are most relevant to the user's instantiated context are placed at the top of the shortlist.

When a significant volume of data is indexed, e.g. around 2 Gigabytes or

25

more of data, the capabilities of current hardware mean that the invention is likely to be operated in accordance with the first embodiment (i.e. retrieve data only in respect of instantiated interests). In this case, the second retrieving means 213 can be arranged to retrieve information relating to interests other than the instantiated interests at a later (predetermined) time.

30

The shortlist can be stored in the database DB1, and shortlist page views are created (e.g. HTML/WML page views are created comprising shortlist data) for delivery to the user U1 via interfacing means 203.

Interfacing means 203 can be arranged to receive the shortlist page views from the database DB1 at predetermined intervals, and to post that data for display on the user's Terminal T1, T2, T4. In one arrangement the shortlist page views are requested from the second retrieving means 213, and passed from the second
5 retrieving means 213 to the interfacing means 203. As stated earlier, items that rank the highest are displayed at the top of the list. The user U1 can select any of the items on the shortlist, and this selection is posted to second retrieving means 213, which sends a request for data to the URL in the item. Data returned from the URL is then displayed to the user U1.

10

In some instances, the instantiated context of the user U1 may indicate that the user U1 is not disposed to receive information. For example, the user U1 could be travelling, in a meeting, tired, in a badly lit environment etc., in which case responding to the information is difficult. In these situations, the second retrieving
15 means 213 can withhold sending information until the user's context is determined to be more suited to receiving information. The second retrieving means 213 is therefore arranged to receive inputs from the context-determining means 209 that are representative of the user's instantiated context, and compare these with predetermined information providing rules, such as

20 IF (Context == tired) OR (Context == Away) OR (Context == Low light) OR (Context includes travelling) etc.

THEN (Set a timer (X mins) to check for context after X mins) where X is predefined

ELSE (Send information to user)

Clearly other forms of rules are possible.

25

Adaption of profile:

The embodiment presented above describes ranking items on a user's shortlist in accordance with the user's instantiated context, so that information relating to instantiated interests is presented to the user U1 first. In addition to the
30 context information, preference attributes such as relevance, importance, etc. (described above) are also factored into the ranking process. However, it may be that the user U1 habitually ignores information relating to a particular interest (this is

particularly possible for interests that have been derived implicitly based on rules (see example below)).

As shown in Figure 7, the information provider 200 can further include monitoring means 701 for observing the way in which the user U1 accesses items on the shortlist, and adapting attributes of the user's interests accordingly. Preferably the monitoring means 701 includes a Bayes net 703 and co-operates with the second retrieving means 213. Items on the shortlist are input to the Bayes net 703, shown in Figure 8, to compute a priority associated with interests corresponding to those items. As known in the art, a Bayes net considers the causal relation of history data in order to modify the a-priori probability of the occurrence of an event. A discussion of Bayes nets is given in "Artificial Intelligence – A Modern Approach" by S. Russell and P. Norvig, Prentice Hall, USA.

The Bayes net 703 is operable to adapt the preference attributes, based on how the user U1 is observed to deal with items on the shortlist. For example, items that are placed high up the shortlist suggest that the information source is relevant to the user. In practice, however, the user may choose to access information relating to that interest later in the day. If that is the case, the monitoring means 701 uses the Bayes net 703 to modify the preference attributes, such that the next time an item relating to the interest appears on the shortlist, the monitoring means 701 can anticipate how the user U1 will want to deal with it, and factor this into the ranking of the interest accordingly.

In addition to implicitly adapting the user's profile as described above, the second retrieving means 213 can be further arranged to receive information from the profile modifier 301. As described above, profile modifier 301 can push questions out to the user U1, requesting explicit rating of information sources – e.g. the user U1 could be presented with ratings from -2 to +2, and asked to indicate how relevant a particular information source was to them. In general, if a user returns a high score, second retrieving means 213 lowers the threshold of the relevance preference attribute in respect of interests that relate to that information source; conversely, if the user returns a low score, second retrieving means 213 increases the relevance threshold.

If a user continually assigns a low score to information sources that have been identified for an interest, this could indicate that the keywords associated with the interest need modifying. The system administrator would either perform modification of keywords explicitly, or the user could be prompted to suggest some keywords. The user's response to the modified keywords could be monitored by the feedback, providing a means of improving the quality of the keywords in respect of an interest.

Data storage

10 The information provider 200 is capable of providing information for many users, and a shortlist page view is generated for each user, on a per-user basis, every time the user requests information (automatically or manually). This places significant loads on various components of the information provider 200, which can be reduced by caching data. The objective is to create pages, which are to be viewed by users, on the cache once only (i.e. request data from its stored location once only), so that any subsequent request for the page can be delivered from the cache. This shortens the request-response chain, improves response time, and reduces network load. The second type of caching arrangement, where the items on the shortlist are cached, describes an embodiment of the present invention.

20

Several caching arrangements are used:

1. *The results of the queries for all users are cached.*

It is possible that, where there are a large number of users, some of the interests will overlap – i.e. User U1 will have some interests that are identical to the interests of user U2 (even though the context attribute tagged to the interest may vary between users), and it would therefore be inefficient to perform the same query a number of times.

Consider performing a query – in respect of interests I1...In – for user U1 (assume that this query has not been performed before).

- 30 • In accordance with Figure 6, second retrieving means 213 retrieves (step S6.3) URL and information source names corresponding to information sources that are relevant to the user's instantiated context. This is stored in a query cache, which can be provided by storage on the database DB1.

- Keywords relating to the interests I1 ...In are hashed, saved e.g. in a file or similar, and linked to the respective identifiers in the query cache.
- When a new query arrives in respect of interests J1 ... Jn (e.g. for user U2), the corresponding keywords are compared with the hashed keywords to identify whether a query has already been processed in respect of those interests.
- If so:
 - second retrieving means 213 does not have to perform a query in respect of interests J1 ... Jn, and
 - interests J1 ... Jn are linked to the identified items in the query cache.

10 In situations where users have specified their own keywords to characterise an interest, it is quite likely that the keywords specified by one user will be different to those specified by another user. Despite the fact that the actual words are different, there may be some overlap in their meaning, so that a query performed in respect of one user's keywords may well overlap with a query in respect of another

15 user's keywords. Thus, in addition to performing a check for identity between keywords corresponding to serviced queries and incoming queries, incoming keywords and serviced keywords could be passed through a Lexicon, or word list such as a thesaurus, so as to identify alternatives to these keywords. These alternative words and phrases would then be compared, in order to identify serviced

20 keywords that overlap with incoming keywords. If there is overlap between alternatives, then the interests corresponding to the incoming query are linked to whichever items correspond to the identified keywords.

Queries could be monitored for their time of request and degree of commonality across the user community, so that queries in respect of requests that are determined to occur frequently, and within a particular time interval, could be automatically performed at a predetermined time.

2. The content of the shortlist for each user is cached.

As described above, the items on the shortlist for each user comprise

30 information, such as URL and information source names, corresponding to information sources that have been identified as relevant to a user's interest (and instantiated context). In one embodiment of the invention, each shortlist is created from the contents of the query cache. The items are then preferably post-processed

by second retrieving means 213 to identify duplicates, and, as described above, the items are ranked in accordance with the user's instantiated context prior to storing in the database DB1. Typically, there will be a considerable number of items on the shortlist, but only a selection can be displayed to the user at any one time due to
5 terminal display constraints. Thus the items on the shortlist need to be cached in a content cache (for each user), which can be provided by storage on the database DB1, so that the post-processing described above does not have to be performed for each selection of items that is displayed to the user.

10 *3. The page views comprising information on the shortlist are cached.*

As described above, the page views comprising the shortlist data are typically created using WML/HTML (although other formats are possible, see later). In one embodiment of the invention, the page views comprise sections of the shortlist stored in the content cache. These page views are retrieved using HTTP, which is a
15 request-response type of protocol – in its simplest configuration a client application, here the retrieving means 213, sends a request to a server, here the index generator 205, and then the index generator 205 responds to the request by retrieving data from the content cache and sending it to the second retrieving means 213. In this configuration, there is a cache as an intermediary, such that the retrieving means 213
20 makes its request to the cache (e.g. a request for a page view showing the shortlist) instead of to the index generator 205. The cache then makes the request to the index generator 205 on behalf of the retrieving means 213. The index generator 205 replies to the cache, and then the cache relays this to the retrieving means 213 (which passes the information on to the interfacing means 203). Each page view
25 should obey the HTTP 1.1 caching rules (see "Illustrated guide to HTTP", Paul Hethmon, Manning Publications Co. or RFC 2616 Hypertext Transfer Protocol -- HTTP/1.1. R. Fielding, J. Gettys, J. Mogul, H. Frystyk, L. Masinter, P. Leach, T. Berners-Lee. June 1999. (Format: TXT=422317, PS=5529857, PDF=550558 bytes) (Obsoletes RFC2068) (Updated by RFC2817) (Status: DRAFT STANDARD)); in
30 particular the following must be included in the response header of the page views:

- (i) Expiry header, with HTTP date;
- (ii) Cache-control: max-age=sec tag, stating lifetime of the content;
- (iii) Content-length response header (which also allows persistent connections)

In one arrangement, the network address (URL, item 3 in the index table) is pre-appended with the user's session ID, and changes to the session ID, such as changes to the user profile, updates to information sources etc. are used to control operation of the cache (when a user's profile is modified (e.g. an interest is added) then the
5 cached page views are out of date (because the content populating the page view is out of date); to prevent these old pages being sent to the user U1, the session ID changes). Thus once the session ID changes, the cache is triggered to request new data from the index generator 205, and thus from the content cache. If the session ID changes because there has been a change to the user profile, it is likely that the
10 content cache for that user will need to be flushed, and populated with new data from the query cache.

Additional Details and Modifications

Context changes:

15 In the above description, the context of the user U1 is determined by context-determining means 209, and this information is used to arrange the data on the shortlist. However, it may be that the user U1 wishes to view information relating to a context other than his present one. For example, if the user U1 is at work, he may wish to see news relating to his football team, Startreck United. The interest
20 football is likely to be accompanied by the contexts Play, Home or Play, Away. Assuming the information provider 200 is arranged to retrieve information relating to the user's instantiated context only, the user U1 has to explicitly change the context in order to view this information. The form displayed on the browsers (on any of the terminals T1, T2, T4) thus includes means for entering a request for change of
25 context – either by entering a time, from which a context will be derived, or by explicitly entering the new context. When this form is posted by interfacing means 203, as described above, the new context information is sent to the first retrieving means 211, and inputs from the context-determining means 209 are disabled.

Different types of contexts can also be included – e.g. friends/family, and all
30 of these contexts can be categorised by weekday and weekend (as weekend leisure activities are likely to be different from week day leisure activities).

Categorising types of users:

When a user U1 first subscribes to the system, the form presented to the user U1 on his browser can include a plurality of drop down menus and lists comprising interests selectable by the user. As an alternative, or in addition, the form can include descriptions of types of users, and the user U1 can indicate which type of user he is. For example, there may be several boots buttons:

- Slippers button
- Stiletto button
- Trendy trainers button
- Walking boot button
- 10 • Cowboy boot button etc..

Each of these buttons has a pre-configured list of interests appended thereto, and, upon selection of one of the buttons, all of the respective interests will be assigned to the user U1.

As an additional or alternative use for the buttons, the user U1 is prompted to select which of these buttons best represents them. The profiler 201 can be arranged to maintain lists of users against type of button and perform some sort of collaborative filtering and implicit filtering of interest data between similar types of users.

20 *Format of data:*

The information may be summarised and delivered, and optimised to, a variety of formats/devices. The formats included, but are not limited to, HTML, WML, I-mode (cHTML), VxML, XML, Postscript, PDF. The devices include but are not limited to PCs, mobile phones, PDAs, other communications devices, games consoles, set-top boxes, multi-media kiosks, wearable computers, FAX and printed hardcopy.

The information may be delivered on demand or alerted to the user U1. The alerting may use a number of mechanisms including but not limited to email, Internet Push services, SMS, WAP Push services, Voice.

30 The indexing of data by Index generator 205 includes both local and remote sources held in formats including, but not limited to, XML, HTML, WML, CHTML, plain text, RTF and speech.

The networks over which data is transmitted further includes UMTS, GPRS packet switched mobile networks.

Example of implicit adaption of profile: traffic information

5 Assume that the user U1 has explicitly specified an interest in motorsport, transport and cars etc. for contexts Work and Home, and the profiler 201 includes a rule that states "If a user has an interest in motor vehicles, include an interest in traffic reports". In accordance with the description above, the user's profile will be modified to include the interest traffic. Assume further that the information provider
10 200 is arranged to automatically send the user U1 data at 08:30 every day. The context determining means 209 determines that the user is on his way to work (inputs from the tracking device 405 indicate that the user is moving, and that the movement is taking the user U1 closer to work and further from home; inputs from the diary and clock 401, 403 confirm that the user is on his way to work). The first
15 retrieving means 211 retrieves information from the user's profile relating to his instantiated context, and passes this information to the second retrieving means 213, which compiles a shortlist of information sources relevant to the user's interests, and sends the shortlist to retrieval engine 701, before the shortlist is transmitted to the user's terminal T1. As the traffic interest is relevant to the user's current context, the
20 ranking associated with the traffic interest is likely to be high, and thus the interest appears relatively high up the shortlist. However, assume that the user chooses to ignore the traffic interest: the Bayes net 703 modifies the preference weight associated with traffic, such that the next day (assuming the user is determined to be in same context) this modified preference weight will be applied and the interest is
25 likely to appear further down the list (the actual position depending on the degree to which the weight is modified).

The degree to which the preference weight is modified can depend on the number of days an interest is ignored, so that some sort of time dependent function is applied to calculate the weight.

30

Aspects of the information provider 200, in particular the profile information stored on database DB1, may be operated behind a firewall, so that external parties cannot gain access to profile information. Alternatively the whole system could be

run from within an intranet, or a secure network environment, such that the only communication with external systems is to receive updated information sources, for indexing purposes, and to communicate with a mobile user.

As will be understood by those skilled in the art, the invention described above may be embodied in one or more computer programs. These programmes can be contained on various transmission and/or storage mediums such as a floppy disc, CD-ROM, or magnetic tape so that the programmes can be loaded onto one or more general purpose computers or could be downloaded over a computer network using a suitable transmission medium.

5

Unless the context clearly requires otherwise, throughout the description and the claims, the words "comprise", "comprising" and the like are to be construed in an inclusive as opposed to an exclusive or exhaustive sense; that is to say, in the sense of "including, but not limited to". The words "X including Y" and the like are to be construed as indicating that X has at least Y, but that X most likely has other elements in addition to Y.

10

CLAIMS

1. A method of storing information in respect of subject matter of interest to a user
5 on the basis of a state of the user, wherein the subject matter of interest includes a plurality of sets of keywords, each set of keywords having at least one identifiable state of the user and/or environment allocated thereto, the method including the steps of:
- 10 (i) retrieving information on the basis of the subject matter of interest and an identified state of the user and/or environment,
 - (ii) organising the retrieved information in accordance with a plurality of criteria, at least one of which includes the identified state of the user or the environment, and
 - (iii) storing the organised information.
- 15
2. A method according to claim 1, in which the organising step (ii) comprises
tagging the retrieved information in accordance with whichever state was
allocated to its corresponding set of keywords,
ranking said tagged information, at least on part, in accordance with the
20 identified state of the user and/or environment, and
arranging the tagged information in accordance with the rankings associated therewith.
3. A method according to claim 2, further including the steps of
25 identifying duplicates in the tagged information, and
removing duplicates so that there is only one of each tagged information.
4. A method according to claim 3, further including the step of assigning a
predetermined ranking to the tagged information for which there are duplicates.
- 30
5. A method according to any one of the preceding claims including presenting the
retrieved information to the user via a terminal, said presentation of information
including creating a viewable page comprising at least some of the retrieved

- information, such that when a viewable page is created, a selection of said stored information is retrieved in accordance with display capabilities of the terminal.
6. A method according to any one of the preceding claims, wherein the identifiable
5 state of the user includes a user's current state.
7. A method according to any one of claims 1 to 5, wherein the identifiable state or the user includes a user's future state.
- 10 8. A method according to any one of the preceding claims, wherein the identifiable state of the environment includes at least one of weather, temperature, and/or time of day.
9. A computer program, or a suite of computer programs, comprising a set of
15 instructions to cause a computer, or a suite of computers, to perform the method steps according to any of the preceding claims.
10. A method of identifying information, the method including the steps of:
receiving a first prompt to retrieve information of interest to a user,
20 constructing a query in response to the first prompt,
using the query to retrieve information of interest to the user,
storing the retrieved information,
receiving a second prompt to retrieve information of interest to a user,
comparing the first and second prompts and, in the event of similarity;
25 identifying the information stored in response to the first prompt as being relevant to the second prompt.
11. A method according to claim 10, wherein a prompt comprises a request from a user.
30
12. A method according to either one of claims 10 or 11, wherein a prompt comprises a timed trigger to retrieve information.

13. A method according to any one of claims 10 to 12, wherein a prompt comprises a change of state of the user.

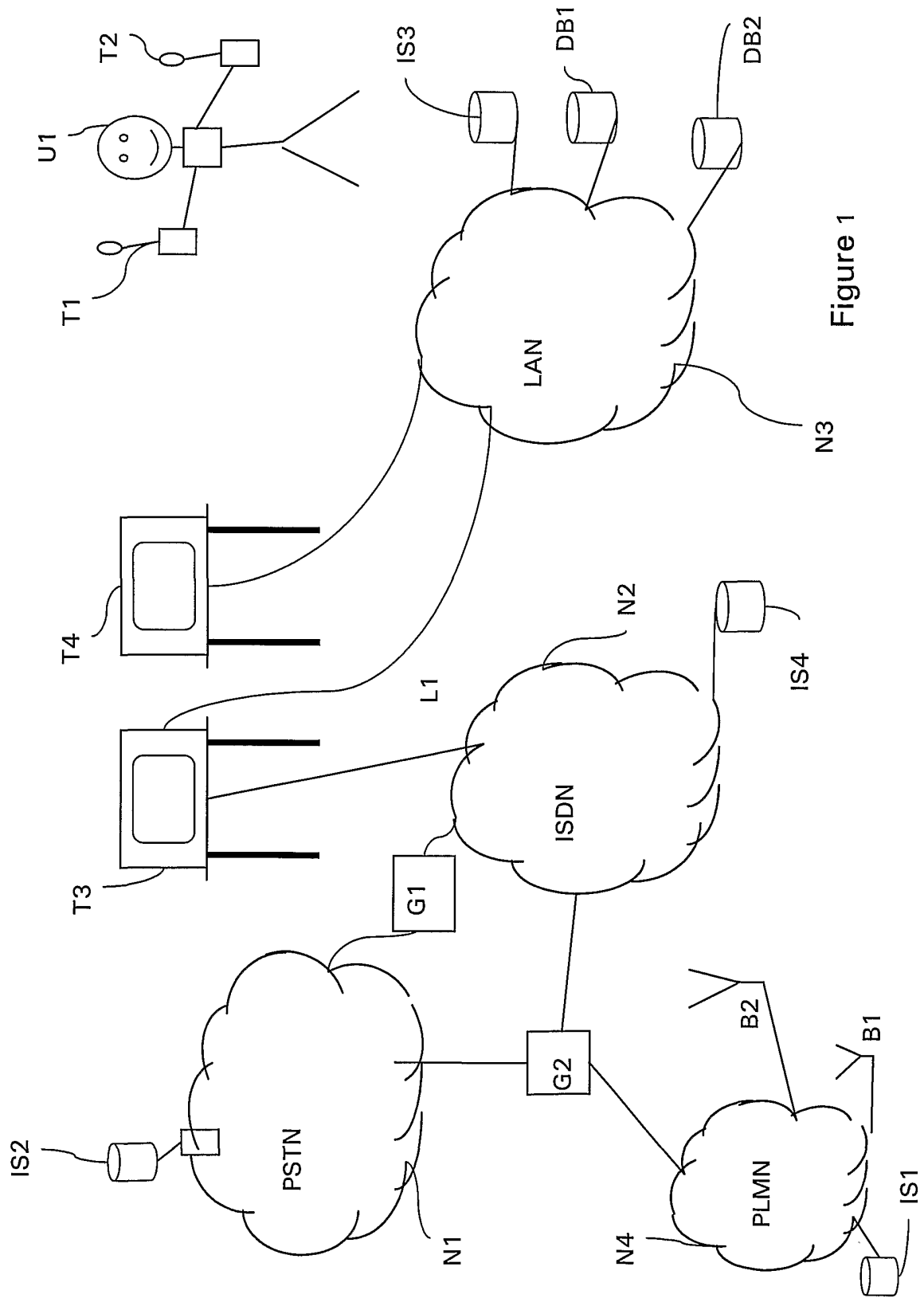

Figure 1

2/7

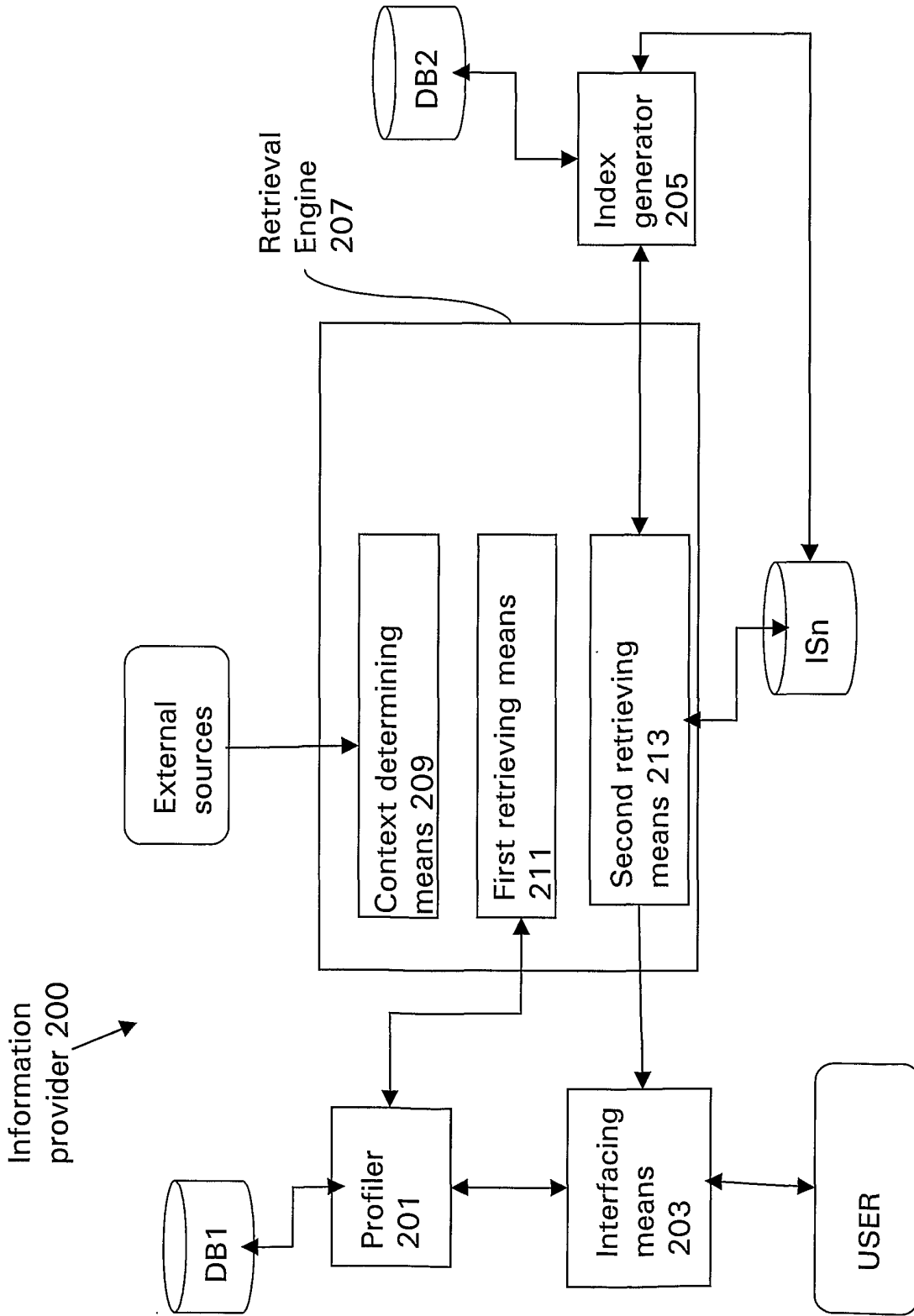

Figure 2

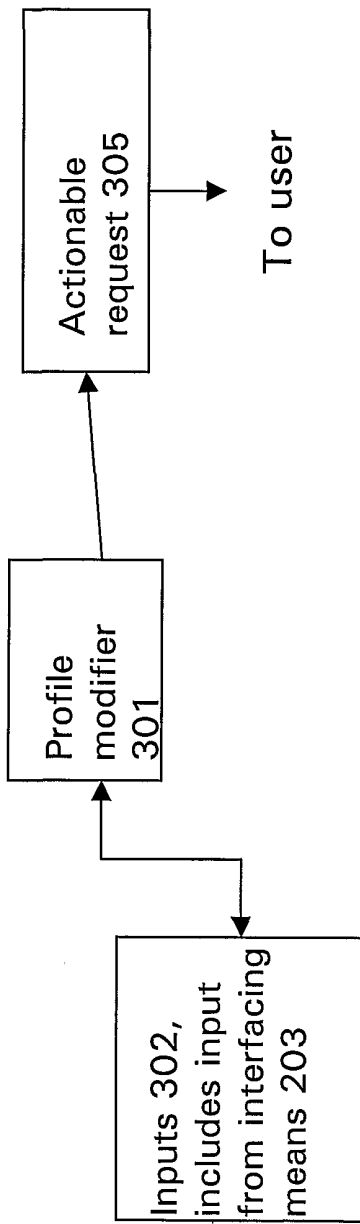

Figure 3

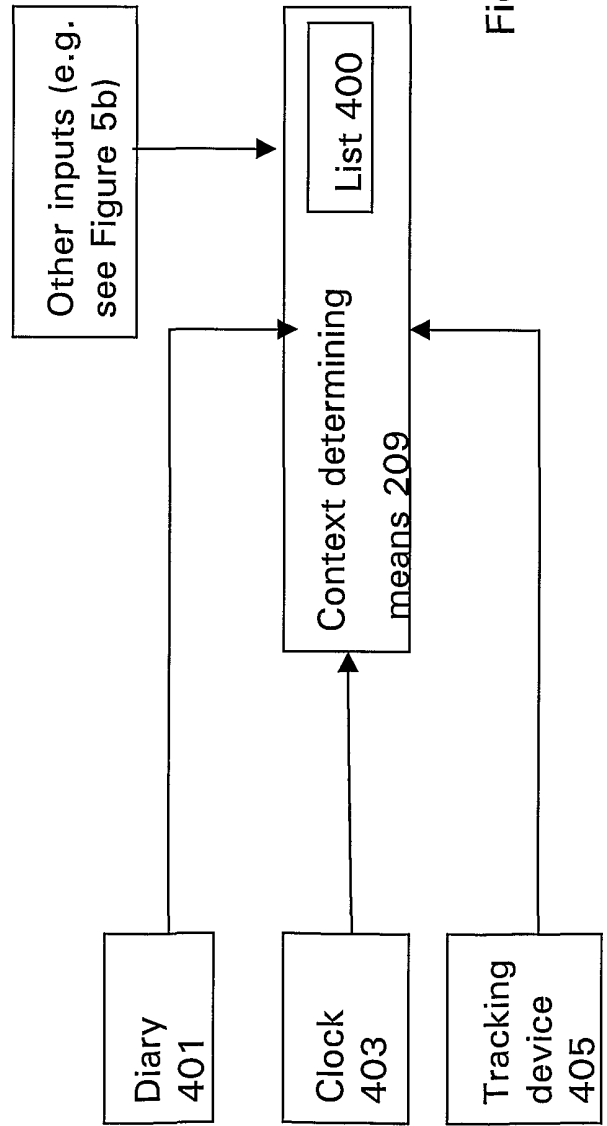

Figure 4

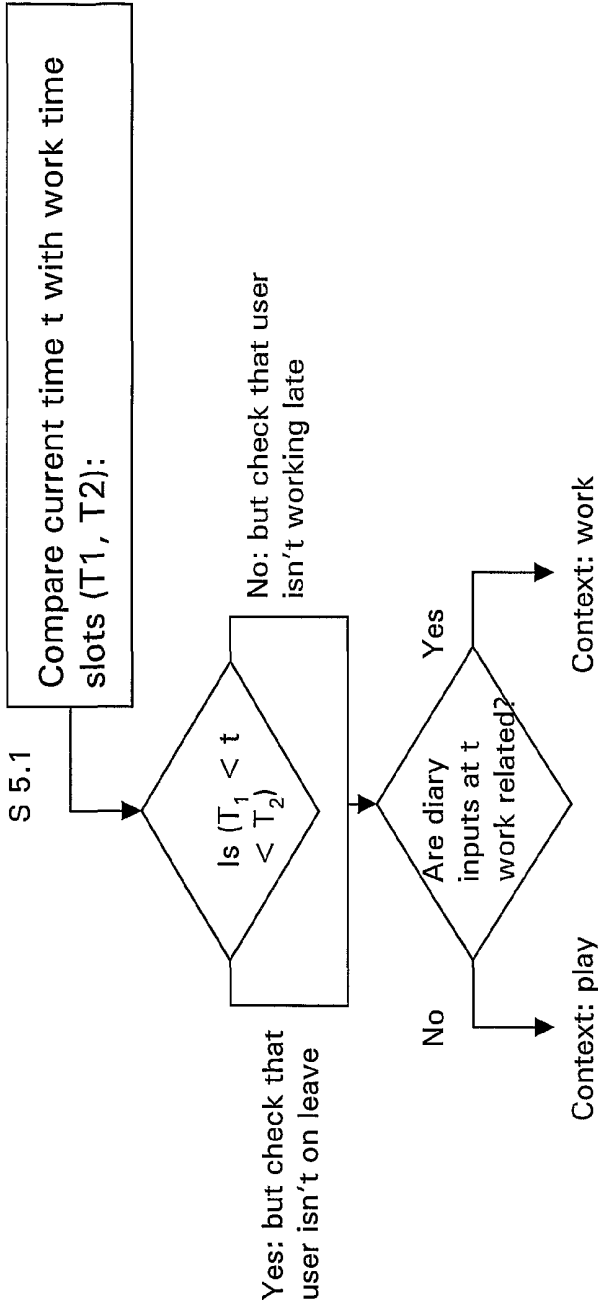
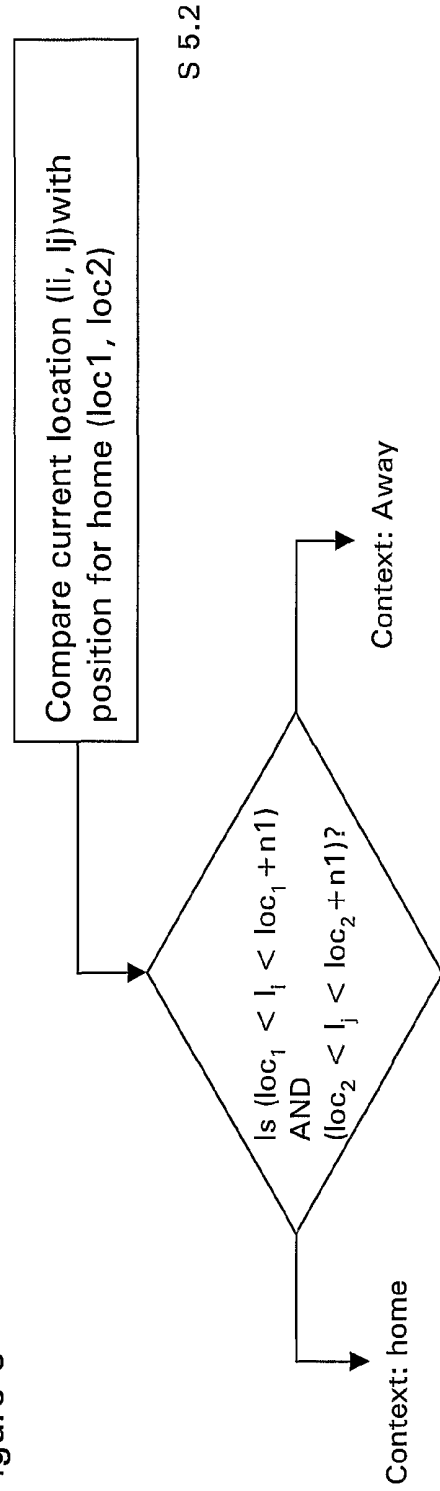

Figure 5



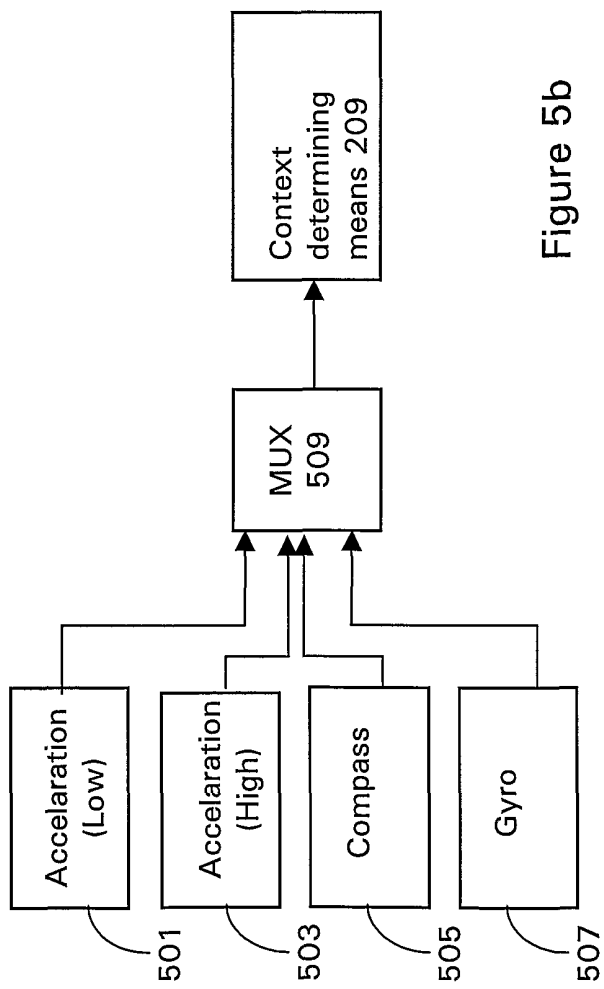

Figure 5b

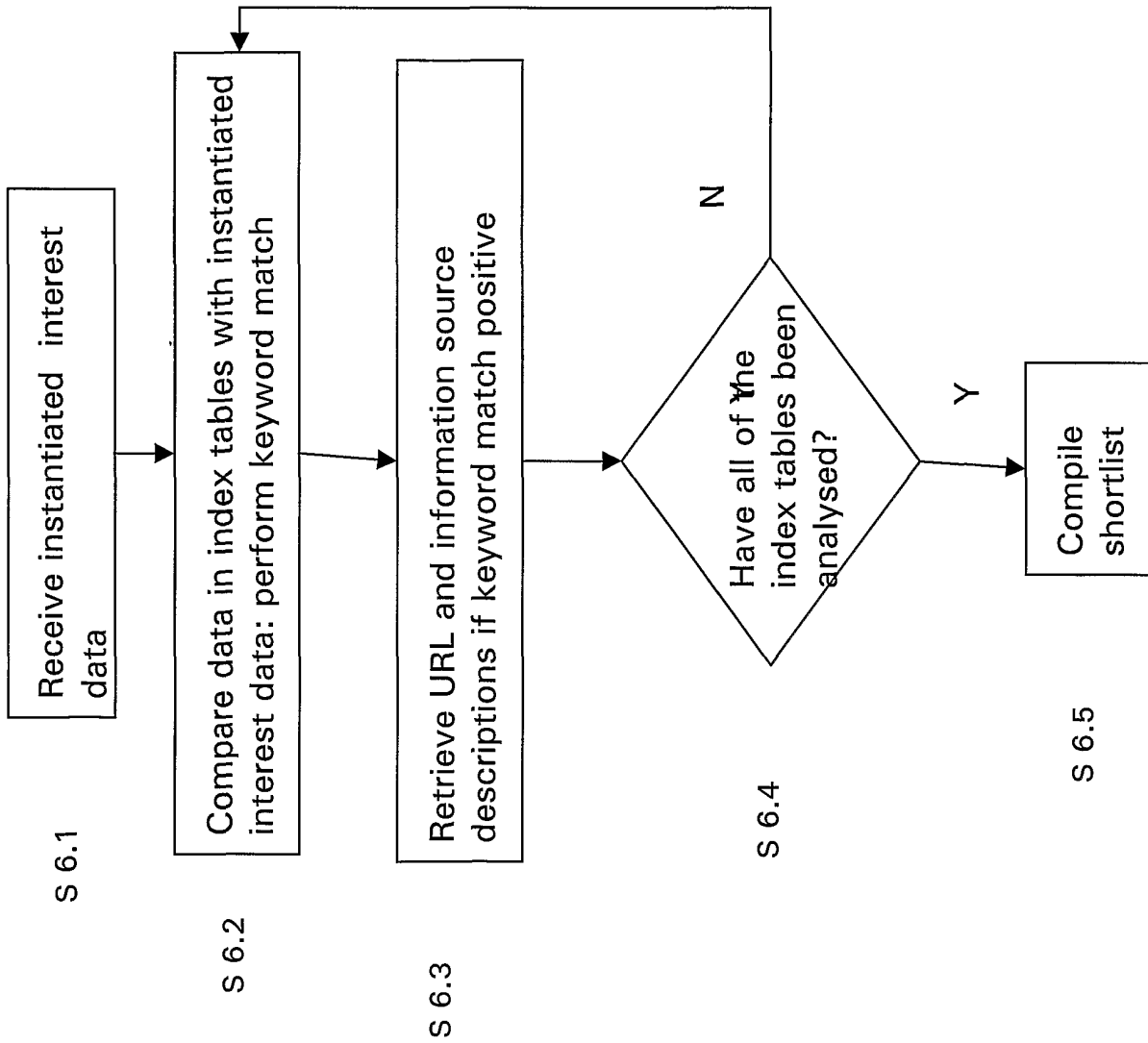

Figure 6

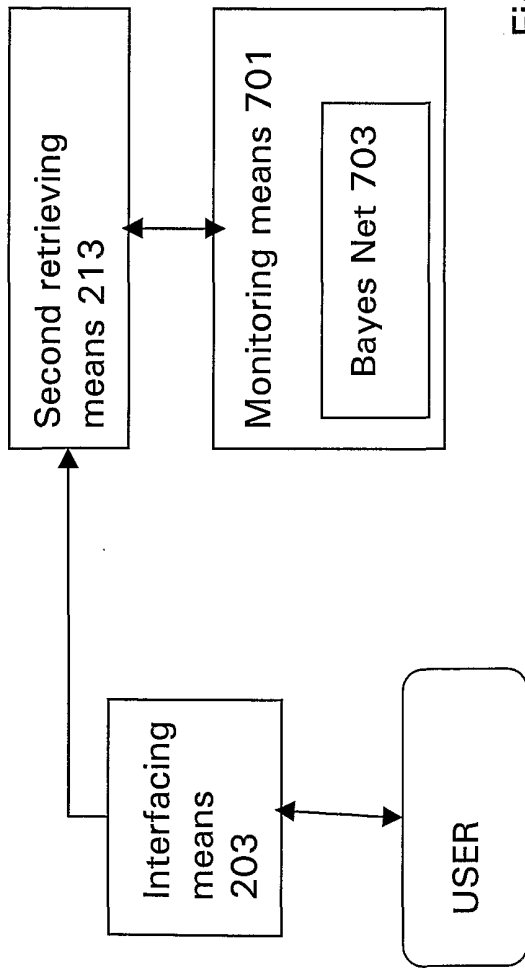

Figure 7

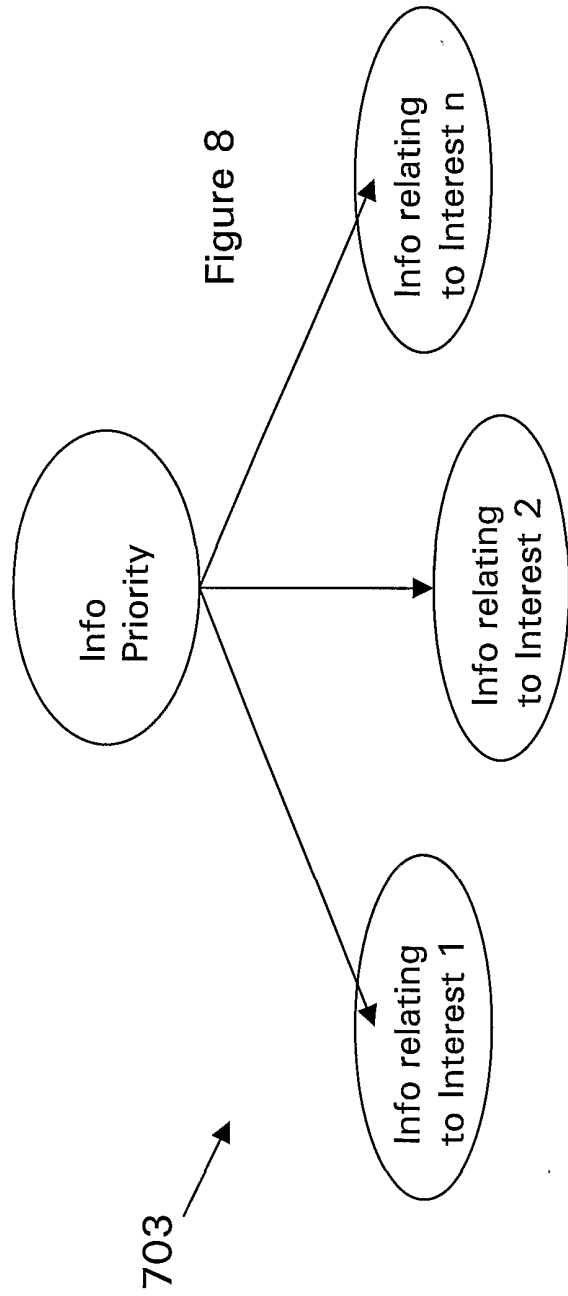

Figure 8

INTERNATIONAL SEARCH REPORT

International Application No
PCT/GB 01/05051

A. CLASSIFICATION OF SUBJECT MATTER IPC 7 G06F17/30				
According to International Patent Classification (IPC) or to both national classification and IPC				
B. FIELDS SEARCHED				
Minimum documentation searched (classification system followed by classification symbols) IPC 7 G06F				
Documentation searched other than minimum documentation to the extent that such documents are included in the fields searched				
Electronic data base consulted during the international search (name of data base and, where practical, search terms used) EPO-Internal, WPI Data, INSPEC, PAJ				
C. DOCUMENTS CONSIDERED TO BE RELEVANT				
Category °	Citation of document, with indication, where appropriate, of the relevant passages	Relevant to claim No.		
X	FREYTAG C ET AL: "Resource adaptive WWW access for mobile applications" COMPUTERS AND GRAPHICS, PERGAMON PRESS LTD. OXFORD, GB, vol. 23, no. 6, December 1999 (1999-12), pages 841-848, XP004187832 ISSN: 0097-8493 abstract page 846, right-hand column, line 15 -page 847, left-hand column, line 17 --- -/--	1,5-7,9		
<table style="width: 100%; border: none;"> <tr> <td style="width: 50%; border: none;"> <input checked="" type="checkbox"/> Further documents are listed in the continuation of box C. </td> <td style="width: 50%; border: none;"> <input checked="" type="checkbox"/> Patent family members are listed in annex. </td> </tr> </table>			<input checked="" type="checkbox"/> Further documents are listed in the continuation of box C.	<input checked="" type="checkbox"/> Patent family members are listed in annex.
<input checked="" type="checkbox"/> Further documents are listed in the continuation of box C.	<input checked="" type="checkbox"/> Patent family members are listed in annex.			
° Special categories of cited documents :				
<table style="width: 100%; border: none;"> <tr> <td style="width: 50%; border: none; vertical-align: top;"> *A* document defining the general state of the art which is not considered to be of particular relevance *E* earlier document but published on or after the international filing date *L* document which may throw doubts on priority claim(s) or which is cited to establish the publication date of another citation or other special reason (as specified) *O* document referring to an oral disclosure, use, exhibition or other means *P* document published prior to the international filing date but later than the priority date claimed </td> <td style="width: 50%; border: none; vertical-align: top;"> *T* later document published after the international filing date or priority date and not in conflict with the application but cited to understand the principle or theory underlying the invention *X* document of particular relevance; the claimed invention cannot be considered novel or cannot be considered to involve an inventive step when the document is taken alone *Y* document of particular relevance; the claimed invention cannot be considered to involve an inventive step when the document is combined with one or more other such documents, such combination being obvious to a person skilled in the art. *&* document member of the same patent family </td> </tr> </table>			*A* document defining the general state of the art which is not considered to be of particular relevance *E* earlier document but published on or after the international filing date *L* document which may throw doubts on priority claim(s) or which is cited to establish the publication date of another citation or other special reason (as specified) *O* document referring to an oral disclosure, use, exhibition or other means *P* document published prior to the international filing date but later than the priority date claimed	*T* later document published after the international filing date or priority date and not in conflict with the application but cited to understand the principle or theory underlying the invention *X* document of particular relevance; the claimed invention cannot be considered novel or cannot be considered to involve an inventive step when the document is taken alone *Y* document of particular relevance; the claimed invention cannot be considered to involve an inventive step when the document is combined with one or more other such documents, such combination being obvious to a person skilled in the art. *&* document member of the same patent family
A document defining the general state of the art which is not considered to be of particular relevance *E* earlier document but published on or after the international filing date *L* document which may throw doubts on priority claim(s) or which is cited to establish the publication date of another citation or other special reason (as specified) *O* document referring to an oral disclosure, use, exhibition or other means *P* document published prior to the international filing date but later than the priority date claimed	*T* later document published after the international filing date or priority date and not in conflict with the application but cited to understand the principle or theory underlying the invention *X* document of particular relevance; the claimed invention cannot be considered novel or cannot be considered to involve an inventive step when the document is taken alone *Y* document of particular relevance; the claimed invention cannot be considered to involve an inventive step when the document is combined with one or more other such documents, such combination being obvious to a person skilled in the art. *&* document member of the same patent family			
Date of the actual completion of the international search <p style="text-align: center; font-size: 1.2em;">2 April 2002</p>		Date of mailing of the international search report <p style="text-align: center; font-size: 1.2em;">09/04/2002</p>		
Name and mailing address of the ISA European Patent Office, P.B. 5818 Patentlaan 2 NL - 2280 HV Rijswijk Tel. (+31-70) 340-2040, Tx. 31 651 epo nl, Fax: (+31-70) 340-3016		Authorized officer <p style="text-align: center; font-size: 1.2em;">Boyadzhiev, Y</p>		

INTERNATIONAL SEARCH REPORT

Inter Application No
PCT/GB 01/05051

C.(Continuation) DOCUMENTS CONSIDERED TO BE RELEVANT		
Category °	Citation of document, with indication, where appropriate, of the relevant passages	Relevant to claim No.
X	SCHMIDT A ET AL: "There is more to context than location" COMPUTERS AND GRAPHICS, PERGAMON PRESS LTD. OXFORD, GB, vol. 23, no. 6, December 1999 (1999-12), pages 893-901, XP004187838 ISSN: 0097-8493	1,6,8,9
A	abstract page 893, right-hand column, line 9 -page 894, right-hand column, line 4 page 895, left-hand column, line 15 -page 896, right-hand column, line 30 ----	2
X	EP 0 786 728 A (HITACHI LTD) 30 July 1997 (1997-07-30) column 3, line 44 -column 4, line 22 column 9, line 38 -column 11, line 55 column 13, line 1-19 ----	1,8,9
X	EP 1 045 318 A (CIT ALCATEL) 18 October 2000 (2000-10-18) column 3, line 11-28 column 4, line 42-54; claim 1 ----	1,9-11
A	US 5 893 091 A (HINES JR ROBERT L ET AL) 6 April 1999 (1999-04-06) column 4, line 38 -column 5, line 60 -----	1-13

INTERNATIONAL SEARCH REPORT

Inte Application No
PCT/GB 01/05051

Patent document cited in search report		Publication date	Patent family member(s)	Publication date
EP 0786728	A	30-07-1997	EP 0786728 A1	30-07-1997
			US 6006251 A	21-12-1999
			WO 9703404 A1	30-01-1997
EP 1045318	A	18-10-2000	FR 2792484 A1	20-10-2000
			EP 1045318 A1	18-10-2000
US 5893091	A	06-04-1999	NONE	