

(19) World Intellectual Property Organization
International Bureau



(43) International Publication Date
6 March 2003 (06.03.2003)

PCT

(10) International Publication Number
WO 03/017843 A1

- (51) International Patent Classification⁷: A61B 8/00
- (21) International Application Number: PCT/US02/27130
- (22) International Filing Date: 26 August 2002 (26.08.2002)
- (25) Filing Language: English
- (26) Publication Language: English
- (30) Priority Data:
- | | | |
|------------|-------------------------------|----|
| 60/314,788 | 24 August 2001 (24.08.2001) | US |
| 60/316,842 | 31 August 2001 (31.08.2001) | US |
| 09/738,514 | 15 December 2001 (15.12.2001) | US |
- (63) Related by continuation (CON) or continuation-in-part (CIP) to earlier applications:
- | | |
|----------|-------------------------------|
| US | 60/314,788 (CIP) |
| Filed on | 24 August 2001 (24.08.2001) |
| US | 60/316,842 (CIP) |
| Filed on | 31 August 2001 (31.08.2001) |
| US | 09/738,514 (CIP) |
| Filed on | 15 December 2001 (15.12.2001) |
- (71) Applicant (for all designated States except US): THE BRIGHAM AND WOMEN'S HOSPITAL, INC. [US/US]; 75 Francis Street, Boston, MA 02115 (US).
- (72) Inventors; and
- (75) Inventors/Applicants (for US only): HYNYNEN, Kullervo [FI/US]; 57 Indian Hill Road, Medfield, MA 02052 (US). CLEMENT, Gregory, T. [US/US]; 116 Sycamore Street, #30, Somerville, MA 02145 (US).
- (74) Agent: ELRIFI, Ivor, R.; Mintz, Levin, Cohn, Ferris, Glovsky, and Popeo, P., C., One Financial Center, Boston, MA 02111 (US).
- (81) Designated States (national): AE, AG, AL, AM, AT, AU, AZ, BA, BB, BG, BR, BY, BZ, CA, CH, CN, CO, CR, CU, CZ, DE, DK, DM, DZ, EC, EE, ES, FI, GB, GD, GE, GH, GM, HR, HU, ID, IL, IN, IS, JP, KE, KG, KP, KR, KZ, LC, LK, LR, LS, LT, LU, LV, MA, MD, MG, MK, MN, MW, MX, MZ, NO, NZ, OM, PH, PL, PT, RO, RU, SD, SE, SG, SI, SK, SL, TJ, TM, TR, TT, TZ, UA, UG, US, UZ, VN, YU, ZA, ZM, ZW.

[Continued on next page]

(54) Title: ULTRASOUND THERAPY

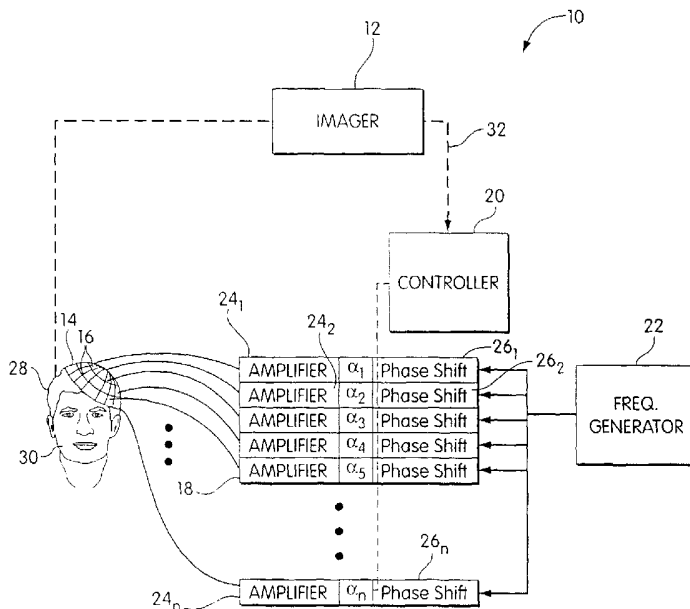

(57) Abstract: A way of delivering ultrasound signals includes providing an image of at least a portion of a subject (30) intended to receive ultrasound signals between sources of the ultrasound signals and a desired region of the subject (3) for receiving focused ultrasound signals, identifying, from the image, physical characteristics of portions of material between the sources and the desired region, and using a spectral propagation analysis to determine at least one of phase corrections and amplitude corrections for the sources depending on the respective physical characteristics of the portions of the material disposed between each source and the desired region.



WO 03/017843 A1



(84) Designated States (regional): ARIPO patent (GH, GM, KE, LS, MW, MZ, SD, SL, SZ, TZ, UG, ZM, ZW), Eurasian patent (AM, AZ, BY, KG, KZ, MD, RU, TJ, TM), European patent (AT, BE, BG, CH, CY, CZ, DE, DK, EE, ES, FI, FR, GB, GR, IE, IT, LU, MC, NL, PT, SE, SK, TR), OAPI patent (BF, BJ, CF, CG, CI, CM, GA, GN, GQ, GW, ML, MR, NE, SN, TD, TG).

— *before the expiration of the time limit for amending the claims and to be republished in the event of receipt of amendments*

For two-letter codes and other abbreviations, refer to the "Guidance Notes on Codes and Abbreviations" appearing at the beginning of each regular issue of the PCT Gazette.

Published:

— *with international search report*

ULTRASOUND THERAPY

FIELD OF THE INVENTION

The invention relates to medical systems and, more particularly, to non-invasive
5 application of focused ultrasound energy to subjects such as humans, and in particular to
the brain of a human subject.

BACKGROUND OF THE INVENTION

Treatment of tissues lying at specific locations within the skull may be limited to
10 removal or ablation. While these treatments have proven effective for certain localized
disorders, such as tumors, they involve delicate, time-consuming procedures that may
result in destruction of otherwise healthy tissues. These treatments are generally not
appropriate for disorders in which diseased tissue is integrated into healthy tissue, except
in instances where destruction of the healthy tissue will not unduly effect neurologic
15 function.

The noninvasive nature of ultrasound surgery has special appeal in the brain
where it is often desirable to destroy or treat deep tissue volumes without disturbing
healthy tissues. Focused ultrasound beams have been used for noninvasive surgery in
many other parts of the body. Ultrasound penetrates well through soft tissues and, due to
20 the short wavelengths (1.5 mm at 1 MHz), it can be focused to spots with dimensions of a
few millimeters. By heating, e.g., using ultrasound, tumorous or cancerous tissue in the

abdomen, for example, it is possible to ablate the diseased portions without significant damage to surrounding healthy tissue.

SUMMARY OF THE INVENTION

5 In general, in one aspect, the invention provides a method of delivering ultrasound signals. The method includes providing an image of at least a portion of a subject intended to receive ultrasound signals between sources of the ultrasound signals and a desired region of the subject for receiving focused ultrasound signals, identifying, from the image, physical characteristics of different layers of material between the sources and
10 the desired region, and determining at least one of phase corrections and amplitude corrections for the sources depending on respective thicknesses of portions of each of the layers disposed between each source and the desired region.

 Implementations of the invention may include one or more of the following features. The physical characteristics are associated with material type and at least one of
15 material density and material structure, the identifying further comprising identifying thicknesses of the layers. The phase corrections are determined in accordance with propagation characteristics of each of the layers. The propagation characteristics are determined based upon the material type and at least one of the material density and the material structure of each of the respective layers. The layers are identified using values
20 associated with portions of the image. The values are intensities of the portions of the image. The phase corrections are determined using a three-layer model of a skull of the

subject. Two of the three layers are assumed to have approximately identical speeds of sound, c_i , therein, with the other layer having a speed of sound c_{ii} therein, wherein the phase corrections are determined using a phase shift determined according to:

$$\phi = 360f \sum_{n=1}^3 D_n \left(\frac{1}{c_0} - \frac{1}{c_n} \right)$$

5 where c_n is a speed of sound in the n^{th} layer, and D_n is a thickness of the n^{th} layer, and wherein the speeds of sound in the layers are determined according to:

$$c_i(\rho) = (d_1 + d_3) \left[\frac{d_1 + d_2 + d_3}{c_0} - \frac{d_2}{c_{ii}} - \frac{\phi(\rho)}{360fD} \right]^{-1}$$

where d_1, d_2, d_3 , are thicknesses of the three layers, $\phi(\rho)$ is a measured phase shift as a function of density, and ρ is density.

10 Further, implementations of the invention may include one or more of the following features. The physical characteristics are associated with x-ray attenuation coefficients, μ . The material between the sources and the desired region is bone. The phase corrections are related to the attenuation coefficient by a phase function including parameters derived at least partially experimentally. Each phase correction equals $M +$
 15 $B\Sigma(1/\mu(x)) + C\Sigma(1/\mu(x))^2$, where $\mu(x)$ is the attenuation coefficient as a function of distance x along a line of propagation between each source and the desired region, and where $M, B,$ and C are derived at least partially experimentally. The amplitude corrections are related to the attenuation coefficient by an amplitude function including parameters derived at least partially experimentally. Each amplitude correction is related
 20 to $N + F\Sigma\mu(x) + G\Sigma(\mu(x))^2$, where $\mu(x)$ is the attenuation coefficient as a function of

distance x along a line of propagation between each source and the desired region, and where N , F , and G are derived at least partially experimentally.

Further, implementations of the invention may include one or more of the following features. The layers are identified according to both material density and material structure. Providing the image includes producing the image using magnetic resonance imaging. Providing the image includes producing the image using computer tomography. The sources are piezoelectric transducer elements. Both phase and amplitude corrections are determined.

In general, in another aspect, the invention provides a system for delivering ultrasound signals. The system includes an apparatus configured to analyze an image of at least a portion of a subject intended to receive ultrasound signals between sources of the ultrasound signals and a desired region of the subject for receiving focused ultrasound signals, the apparatus configured to determine, from the image, information about different layers of the at least a portion of the subject, and an array of sources of ultrasound signals having at least one of their relative phases and their amplitudes set in accordance with the information about each layer of the at least a portion of the subject provided by the apparatus.

Implementations of the invention may include one or more of the following features. The phases are set in accordance with propagation characteristics of each layer of the at least a portion of the subject. The propagation characteristics are dependent upon the material type and at least one of the material density and the material structure

of each layer of the at least a portion of the subject. The apparatus is configured to identify the layers using values associated with portions of the image. The values are intensities of the portions of the image. The apparatus is configured to determine the information about different layers of bone. The apparatus is configured to determine the phase corrections using a three-layer model of a skull of the subject. The information is associated with an x-ray attenuation coefficient, μ . The phase corrections are related to the attenuation coefficient by a phase function including parameters derived at least partially experimentally. The amplitude corrections are related to the attenuation coefficient by an amplitude function including parameters derived at least partially experimentally.

Further, implementations of the invention may include one or more of the following features. The system further includes a magnetic resonance imager coupled to the apparatus and configured to produce the image. The system further includes a computer tomography imager coupled to the apparatus and configured to produce the image. The sources are piezoelectric transducer elements.

In general, in another aspect, the invention provides a computer program product residing on a computer readable medium and comprising instructions for causing a computer to analyze an image of at least a portion of a subject to receive ultrasound signals between sources of the ultrasound signals and a desired region of the subject for receiving focused ultrasound signals to identify, from the image, physical characteristics of layers of material between the sources and the desired region, and to determine at least

one of phase corrections and amplitude corrections for the sources depending on respective thicknesses of portions of each of the layers disposed between each source and the desired region.

Implementations of the invention may include one or more of the following features. The phase corrections are determined in accordance with propagation characteristics of each of the layers. The propagation characteristics are dependent upon the material type and at least one of the material density and the material structure of each of the respective layers. The layers are identified according to both material density and material structure. The computer program product further includes instructions for causing a computer to produce the image using magnetic resonance imaging. The computer program product further includes instructions for causing a computer to produce the image using computer tomography. The instructions for causing a computer to identify layers of materials are for causing the computer to identify the layers of materials based upon intensities of portions of the image.

Further, implementations of the invention may include one or more of the following features. The layers are identified using values associated with portions of the image. The values are intensities of the portions of the image. The layers analyzed are layers of bone. The phase corrections are determined using a three-layer model of a skull of the subject. Two of the three layers are assumed to have approximately the same speed of sound, c_i , therein, with the other layer having a speed of sound c_{ii} therein, wherein the phase corrections are determined using a phase shift determined according to:

$$\phi = 360 f \sum_{n=1}^3 D_n \left(\frac{1}{c_0} - \frac{1}{c_n} \right)$$

where c_n is a speed of sound in the n^{th} layer, and D_n is a thickness of the n^{th} layer, and wherein the speeds of sound in the layers are determined according to:

$$c_i(\rho) = (d_1 + d_3) \left[\frac{d_1 + d_2 + d_3}{c_0} - \frac{d_2}{c_{ii}} - \frac{\phi(\rho)}{360 f D} \right]^{-1}$$

- 5 where d_1, d_2, d_3 , are thicknesses of the three layers, $\phi(\rho)$ is a measured phase shift as a function of density, and ρ is density.

Further, implementations of the invention may include one or more of the following features. The physical characteristics are associated with x-ray attenuation coefficients, μ . The phase corrections are related to the attenuation coefficient by a phase
 10 function including parameters derived at least partially experimentally. Each phase correction equals $M + B\Sigma(1/\mu(x)) + C\Sigma(1/\mu(x))^2$, where $\mu(x)$ is the attenuation coefficient as a function of distance x along a line of propagation between each source and the desired region, and where $M, B,$ and C are derived at least partially experimentally. The amplitude corrections are related to the attenuation coefficient by an amplitude function
 15 including parameters derived at least partially experimentally. Each amplitude correction is related to $N + F\Sigma\mu(x) + G\Sigma(\mu(x))^2$, where $\mu(x)$ is the attenuation coefficient as a function of distance x along a line of propagation between each source and the desired region, and where $N, F,$ and G are derived at least partially experimentally.

In general, in another aspect, the invention provides a method of providing
 20 ultrasound signals into a subject from at least one source of an array of sources of

ultrasound signals. The method includes (a) transmitting ultrasound energy of a selected frequency from a selected source into the subject, (b) receiving superimposed reflections of the transmitted energy, the reflections being from an outer surface of the subject and at least one interface inside the subject, (c) repeating (a) and (b) using ultrasound energy of
5 frequencies other than the selected frequency, (d) determining a frequency difference between frequencies associated with relative extrema of the received reflections, and (e) using the determined frequency difference and a thickness, of at least a portion of material between the selected source and a desired region in the subject for receiving focused ultrasound energy signals, to determine a phase correction for the selected source.

10 Implementations of the invention may include one or more of the following features. The method further includes (f) providing an image of at least a portion of a subject intended to receive ultrasound energy signals between sources of the energy signals and the desired region, and (g) identifying, from the image, the thickness of at least a portion of material between the selected source and the desired region. The
15 method further includes repeating (a) - (e) for each of the sources other than the selected source. The phase correction is determined according to:

$$\Delta\phi = 2\pi f \left[\left(\frac{d}{c_0} \right) - \left(\frac{1}{2\Delta f} \right) \right]$$

where $\Delta\phi$ is the phase correction, f is a frequency to be transmitted, d is the thickness, c_0 is the speed of sound in water, and Δf is the frequency difference between like extrema.

20 In general, in another aspect, the invention provides logic for use in a system for providing ultrasound energy into a living subject from an array of sources of ultrasound

energy signals. The logic is configured to control apparatus to (a) transmit ultrasound energy of a selected frequency from a selected source into the subject, (b) receive superimposed reflections of the transmitted energy, the reflections being from an outer surface of the subject and at least one interface inside the subject, (c) repeat (a) and (b) using ultrasound energy of frequencies other than the selected frequency, (d) determine a frequency difference between frequencies associated with relative extrema of the received reflections, and (e) use the determined frequency difference and a thickness, of at least a portion of material between the selected source and a desired region in the subject for receiving focused ultrasound energy signals, to determine a phase correction for the selected source.

Implementations of the invention may include one or more of the following features. The logic is further configured to cause the apparatus to (f) provide an image of at least a portion of a subject intended to receive ultrasound energy signals between sources of the energy signals and the desired region, and (g) identify, from the image, the thickness of at least a portion of material between the selected source and the desired region. The logic is further configured to cause the apparatus to repeat (a) - (e) for each of the sources other than the selected source. The logic is configured to cause the apparatus to determine the phase correction according to:

$$\Delta\phi = 2\pi f [(d/c_0) - (1/(2\Delta f))]$$

where $\Delta\phi$ is the phase correction, f is a frequency to be transmitted, d is the thickness, c_0 is the speed of sound in water, and Δf is the frequency difference between like extrema.

In general, in another aspect, the invention provides a method of delivering ultrasound signals. The method includes providing an image of at least a portion of a subject intended to receive ultrasound signals between sources of the ultrasound signals and a desired region of the subject for receiving focused ultrasound signals, identifying, 5 from the image, physical characteristics of portions of material between the sources and the desired region, and using a spectral propagation analysis to determine at least one of phase corrections and amplitude corrections for the sources depending on the respective physical characteristics of the portions of the material disposed between each source and the desired region.

10 Implementations of the invention may include one or more of the following features. The physical characteristics include density and thickness. The identifying identifies the physical characteristics of different layers of the portions of the material. The physical characteristics include angle of a layer interface relative to a reference.

15 Implementations of the invention may also include one or more of the following features. The spectral propagation analysis includes a wavevector-frequency domain projection algorithm. The using includes comparing projected phases from the sources to the desired region accounting for the material and ignoring the material. The using assumes perpendicular incidence of ultrasound. The method further includes determining an incident angle of ultrasound to the material. The identifying identifies the physical 20 characteristics of different layers of the portions of the material and the determining an incident angle determines incident angles for each layer of the material.

In general, in another aspect, the invention provides a system for delivering ultrasound signals. The system includes an apparatus configured to analyze an image of at least a portion of a subject intended to receive ultrasound signals between sources of the ultrasound signals and a desired region of the subject for receiving focused ultrasound signals, the apparatus configured to determine, from the image using a spectral projection analysis, information about the at least a portion of the subject, and an array of sources of ultrasound signals having at least respective ones of their relative phases and their amplitudes set in accordance with the information about the at least a portion of the subject provided by the apparatus.

10 Implementations of the invention may include one or more of the following features. The apparatus comprises means for identifying physical characteristics of multiple layers of the portion of the subject, the physical characteristics including density and thickness. The physical characteristics further include incident angles of the layers relative to respective sources, the apparatus further comprising means for comparing
15 projected phases of the signals from the sources to the desired region accounting for the portion of the subject and ignoring the portion of the subject. The apparatus comprises means for performing a wavevector-frequency domain projection algorithm.

In general, in another aspect, the invention provides a computer program product residing on a computer readable medium and including computer-readable, computer
20 executable instructions for causing a computer to analyze an image of at least a portion of a subject to receive ultrasound signals between sources of the ultrasound signals and a

desired region of the subject for receiving focused ultrasound signals to identify, from the image, physical characteristics of respective portions of material between the sources and the desired region, and to determine, using a wavevector-frequency domain projection algorithm, at least one of phase corrections and amplitude corrections for the sources
5 depending on respective physical characteristics of portions of the material disposed between each source and the desired region.

Implementations of the invention may include one or more of the following features. The physical characteristics include density and thickness. The instructions for causing the computer to analyze cause the computer to identify the physical
10 characteristics of different layers of the portions of the material. The physical characteristics include angles of layer interfaces relative to the sources.

Implementations of the invention may also include one or more of the following features. The instructions for causing the computer to analyze cause the computer to compare projected phases from the sources to the desired region accounting for the
15 portions of the material and ignoring the portions of the material. The computer program product further includes instructions for causing the computer to determine the projected phases accounting for the portions of the material assuming perpendicular incidence of ultrasound. The computer program product further includes instructions for causing the computer to determine the projected phases accounting for the portions of the material by
20 determining and using incident angles of ultrasound relative to the layers of the portions of the material. The instructions for causing the computer to determine incident angles

cause the computer to determine incident angles for each layer of the portions of the material.

Various aspects of the invention may provide one or more of the following advantages. Ultrasound can be focused accurately within an intact skull, e.g., for
5 ultrasound therapy. Different skulls, e.g., different skull thicknesses, densities, and/or structures, can be accommodated for ultrasound therapy. Real-time adjustments to ultrasound therapy can be made. Effects on phase and/or amplitude of energy passing through bone (or other tissue) may be determined and used to compensate the phase and/or amplitude of energy applied to the bone (or other tissue). Incident angles of
10 ultrasound relative to a skull can be accounted for and excitation characteristics of ultrasound transducers adjusted accordingly. A wavevector-frequency domain projection algorithm can be used to determine ultrasound transducer excitation characteristics for providing ultrasound non-invasively into a skull. Correction factors for ultrasound array transducers can be determined in an efficient, timely manner.

15 These and other advantages of the invention, along with the invention itself, will be more fully understood after a review of the following figures, detailed description, and claims.

BRIEF DESCRIPTION OF THE FIGURES

20 FIG. 1 is a schematic diagram of an ultrasound therapy system according to the invention.

FIG. 2 is a 3-dimensional rendering of a portion of a patient's skull.

FIG. 3 is a flow diagram of a process of determining excitation correction factors and exciting transducer elements using the determined factors.

FIG. 4 is a schematic diagram of another ultrasound therapy system according to
5 the invention.

FIG. 5 is a flow diagram of a process of obtaining phase shift factors using the system shown in FIG. 4.

FIG. 6 is schematic diagram showing planar field rotation in a wavevector-frequency domain, defining a new projection plane.

10 FIG. 7 is a schematic ray diagram of ultrasound propagation through non-parallel layers of different-density materials.

DETAILED DESCRIPTION OF PREFERRED EMBODIMENTS

Energy, such as ultrasound energy, may be propagated into a subject such as a human or animal, for various therapeutic reasons. Arrays of radiating transducer elements may be used to transmit energy into the subject, and the amplitudes of the signals transmitted by the elements can affect how much energy penetrates the subject and the relative phases and amplitudes of energies transmitted can help to focus a distribution of energy in the subject. It has been found that the phases and amplitudes of ultrasound signals may be affected/distorted by many causes such as different material properties of materials through which the signals are propagated. For example, different types of materials within a patient, e.g., bone, muscle, and fat, have different propagation and attenuation constants of ultrasound energy. Also, other material properties, such as the density and structure of materials in a patient, may affect the phase and/or attenuation of ultrasound signals. Because the signals from different transducer elements may encounter different thicknesses and contours of materials and possibly air-filled or liquid-filled pockets between transducer elements and a region to be imaged/treated, the phases of the signals from the transducer elements will often be distorted. The resulting phases and/or amplitudes will therefore often be different than desired if the transmission phases and/or amplitudes are not compensated for this distortion.

Embodiments of the invention provide techniques for compensating for phase distortions and attenuation variances when treating a patient using ultrasound. Using imaging techniques such as computer tomography (CT), magnetic resonance imaging

(MRI), etc., properties such as thickness, density, and structure of materials are determined. It has been discovered that each of these properties affects the phase distortion of materials, so that phase corrections determined using all three properties will be better than those determined using only one or two of the properties. The determined
5 properties for materials in a subject between transducer elements and a region to be treated are inserted into formulas developed by the inventors. The formulas use the determined properties and known characteristics, e.g., propagation speed, to calculate phase adjustments for each of the transducer elements. Compensating the phase in the transducer elements more properly focuses energy within the subject, permitting effective
10 noninvasive therapy, even in sensitive areas such as the brain. Also, x-ray attenuation can be related to phase distortion and acoustic attenuation. Formulas relating to x-ray attenuation to phase distortion and acoustic attenuation can be used to compensate for such variances by adjusting transmitted phase and amplitude accordingly.

Referring to FIG. 1, an ultrasound therapy system 10 includes an imager 12, a
15 phased array 14 of n transducer elements 16, a signal adjuster 18, a controller 20, and a frequency generator 22. The system 10 is configured to determine characteristics of a skull 28 of a patient 30, and to apply ultrasound energy (e.g., in the range 0.01 MHz to 10 MHz) that is focused in the patient's brain. Signals to the array are provided by a driving arrangement similar to that reported in Daum et al., "Design and Evaluation of a
20 Feedback Based Phased Array System for Ultrasound Surgery." IEEE Trans. Ultrason. Ferroelectr. Freq. Control 45(2):431-4, 1998, but with a driving frequency selected

between about 0.1 MHz and about 10 MHz. The power and phase to each transducer element 16 may be manually controlled or automatically controlled using software and feedback.

The array 14 of transducer elements 16 is configured to be disposed on or near the
5 external surface of the patient's skull 28. The array 14 is configured in a curved shape (e.g., spherical, although sections of other shapes are possible such as planar) conducive for being placed on the patient's head and for focusing ultrasound energy at a distance from the surface of the array 14. The transducer elements 16 of the array 14 are piezoelectric transducer elements arranged in the array 14 as shown. The transducer
10 elements (e.g., 1 cm² piezoelectric ceramic pieces) are mounted in silicone rubber or any other material suitable for damping the mechanical coupling between the elements 16. Other materials may also be used for the array construction. For example, the array 14 may be formed from one or more pieces of piezocomposite material, or any material that converts electrical energy to acoustic energy. To help assure maximum power transfer to
15 the transducer elements 16, the transducer elements 16 may be configured for electrical resonance at 50Ω to help match input connector impedance.

The array 14 is coupled to the signal adjuster 18 that is further coupled to the frequency generator 22. The frequency generator 22 is configured to provide a common radio frequency (RF) signal as the input signal to the signal adjuster 18. The radio
20 frequency generator 22 can be of any type that will produce the appropriate signals for the signal adjuster 18. For example, the generator 22 may be a Model DS345 generator

available from Stanford Research Systems. Together, the radio frequency generator 22 and signal adjuster 18 are configured to drive the individual transducer elements 16 of the array 14 at the same frequency, but at different phases (and possibly different amplitudes), in order to transmit ultrasound energy through the patient's skull 28 and focus the energy at a selected region within the patient's brain. The generator 22 is coupled to the adjuster 18 to split the generator's output signal to provide n input signals to the signal adjuster 18.

Coupled to receive each of the n input signals from the frequency generator 22 are n pairs of amplifiers 24₁-24_n and associated phase shifters 26₁-26_n of the signal adjuster 18. Each pair of phase shifter 26 and amplifier 24 represents a channel of the signal adjuster 18. The phase shifters 26 are configured to provide n independent output signals to the amplifiers 24 by altering or adjusting the phase (and possibly amplitude) of the incoming signals from the generator 22 by respective phase shift factors α_1 - α_n . The phase shifters 26 provide approximately 1 degree precision (8-bit resolution, although lower phase resolution may be adequate for many applications). The amplifiers 24₁-24_n are configured to amplify the signals from the phase shifters 26 and to provide the amplified signals to the transducer elements 16 through connections, e.g., coaxial cables, individually connecting the amplifiers 24 and the transducer elements 16. An internal power meter is configured to monitor power supplied by the amplifiers 24.

The phase shift factors α_1 - α_n of the phase shifters 26 provide steering of the ultrasound beam absent an object in the path of the ultrasound energy and also provide

compensation for phase distortion in the ultrasound output by each transducer element 16 induced by the patient's skull. The component of each phase shift factor associated with steering can be computed using known techniques. The component of each phase shift factor α_1 - α_n associated with phase distortion compensates for perturbations and

5 distortions introduced by the skull 28, the skin/skull interface, the dura matter/skull interface, by variations in the skull thickness and by structural considerations such as air-filled or liquid-filled pockets in the skull 28. The two components that make up the phase shift factors α_1 - α_n are summed in order to determine the composite phase shift factors α_1 - α_n for the respective channels in order to focus ultrasound energy at a desired steering

10 angle relative to, and distance from, the array 14.

The phase shift factors α_1 - α_n are provided by the controller 20. The controller 20 is logic that may be provided by software, hardware, firmware, hardwiring, or combinations of any of these. For example, the controller 20 can be a general purpose, or special purpose, digital data processor programmed with software in a conventional

15 manner in order to provide and apply the phase shift factors α_1 - α_n to the phase shifters 26, although other configurations may be used. The controller 20 is configured to determine the phase shift factors α_1 - α_n as described below based on information obtained from the imager 12 as indicated by arrow 32. In particular, the information includes the thickness and density of the patient's skull 28 for each portion of the skull 28 between each

20 transducer element 16 and the desired focal point in the patient's brain. Information from the imager 12 is conveyed directly from the imager 12 because the imager 12 is

configured to automatically analyze images and determine characteristics of interest from the images. Enough information is provided by the imager 12 to the controller 20 to determine the phase shift factors α_1 - α_n .

The controller 20 is configured to manipulate images from the imager 12. The controller 20 is configured to produce a 3-dimensional rendering of the patient's skull 28 from 2-dimensional images received from the imager 12 and to determine skull thickness from the 3-dimensional rendering. The 3-dimensional rendering can be divided by the controller 20 into voxels (a volume pixel of the 3-dimensional image).

The imager 12 is configured to obtain images of the interior of the patient's head, and in particular images that provide information regarding thickness, density, and structure of bone of the patient's skull 28. For example, the imager 12 may be a Magnetic Resonance Imaging (MRI) device or Computer Tomography (CT) device. The imager 12 is configured to scan the patient's skull 28 and provide information related to skull thickness, density and structure. This information includes 2-dimensional images of varying intensity from which 3-dimensional renderings can be made and from which thicknesses and densities can be determined and/or inferred. Three-dimensional image acquisition may also be possible and can be used. Also, if the imager 12 is a CT device, the imager 12 can determine and provide the CT number (also called Hounsfield number) for each pixel in images provided by the imager 12.

Referring also to FIG. 2, the skull 28 includes two layers 50, 54 of trabecular bone and a layer 52 of cortical bone. For reference, a scan direction of the imager 12 is defined

as the Cartesian x-axis so that the image plane is defined by the y-axis and z-axis. From the 3-D rendering, two vectors 34, 36 on the surface 38 of the skull 28 are determined using the 3rd nearest neighboring points on the surface in the x and y directions from the point of interest r_0 on the skull's surface 38. The controller 20 is configured to use the

5 vectors 34, 36 to calculate a vector 40 that is normal to the surface 38. The controller can calculate a scalar product of the vector 40 and a vector 42 that is the direction of propagation of energy from a transducer element 16_x. This scalar product is the incident angle:

$$\boxed{\phantom{\cos \gamma_i = \frac{\mathbf{v} \cdot \mathbf{n}}{|\mathbf{v}| |\mathbf{n}|}}}$$
 (1)

10

A Cartesian (normalized) unit vector $\mathbf{n} = (u,v,w)$ may be calculated by the controller 20 from this incident angle γ_i . Thicknesses, D_1, D_2, D_3 , of each layer 50, 52, 54, respectively, are obtained, using intensity variations, starting at a location on the skull surface $\mathbf{r}_0 = (x_0, y_0, z_0)$ and continuing to a point on the next layer $\mathbf{r} = (x, y, z)$,

15
$$\mathbf{r} = \mathbf{r}_0 + D \mathbf{n}. \tag{2}$$

Near-normal propagation through homogeneous skull bone is assumed. Treating the layers 50, 52, 54 as a single layer for purposes of ultrasound propagation speed, the following simple relation can be used to express the phase shift due to propagation through a given point on the skull.

20
$$\phi = 360 f D \left(\frac{1}{c_0} - \frac{1}{c_s} \right) \tag{3}$$

where f is the driving frequency, the sound speed in water is c_0 , the speed in the skull bone is c_s , and D is the thickness of the skull. This convention of subtracting the phase shift due to direct propagation of the field in water from the shift due to the skull produces a positive phase shift.

5 The three layers 50, 52, 54 can be treated separately to determine phase compensation due to the thicknesses D_1, D_2, D_3 of the layers 50, 52, 54 as part of a three-layer model. For the three-layer model, it has been assumed that the skull 28 consists of individual homogeneous layers. The speed of sound is assumed to be 2.5×10^3 m/s for the central layer 52 and 2.9×10^3 m/s for the inner and outer layers 50, 54. The expected
10 phase shift across the skull 28 using this three-layer model is:

$$\phi = 360f \sum_{n=1}^3 D_n \left(\frac{1}{c_0} - \frac{1}{c_n} \right) \quad (4)$$

with c_n equal to the speed of sound in the n^{th} layer and D_n being the thickness of the n^{th} layer.

It has been found that density of the skull 28 affects the propagation through the
15 skull 28. Consequently, the phase of ultrasound signals passing through the skull 28 is affected by the skull's density, and phase correction based on the skull's density can help improve focusing of ultrasound energy from the array 14.

To assess the contribution of internal density variation to the deviation from the expected single-layer homogeneous values calculated from Eq. (3), a correlation between
20 the mean CT image intensity along the ultrasound axis of propagation 42 and experimental error is used. Using a 3-d image constructed from 2-d CT images, each

0.15 mm² voxel is assigned an intensity value. It is assumed that the intensity is linearly proportional to bone density and density is scaled to MKS units using air and water in the image as reference intensities. Mean intensity is determined by summing the CT intensity values along the axis of propagation 42 inside the bone and dividing by the total number
 5 summed of voxels. The voxels may include air-filled or liquid-filled pockets. The sound speed for such voxels is assumed to be the speed of sound in water, or if air-filled, then complete reflection of the ultrasound can be assumed.

Error due to skull density has been calculated as the difference between the measured phase and that given by Eq. (3) (for a single-layer model). An empirical
 10 correction factor has been obtained by fitting (using a polynomial curve fit) percent error as a function of the mean intensity. The correction factor is:

$$C(\rho) = \sum_{n=0}^N A_n \rho^{N-n} \quad (5)$$

where there are N+1 coefficients A_n to be determined for an Nth degree fit, and ρ is the density. Applying a 3rd order fit using a 117 point data set and five skulls at 0.51 MHz
 15 yielded coefficients, in MKS units, of:

Table 1

A ₀	1.1424e-008
A ₁	-7.5377e-005
A ₂	0.1645
A ₃	-118.689

These coefficients may be used in Eq. (5), and Eq. (5) applied to Eq. (3) as part of the single-layer homogeneous model to yield a corrected phase shift of:

$$\phi = \frac{\Phi}{1+C}, \quad (6)$$

where Φ contains the initial phase values obtained using Eq (3).

- 5 The density and thickness measurements may also be applied toward adjustment of the skull sound speed. To adjust the speed value for a single layer, the controller 20 is configured to fit the speed as a function of density according to:

$$c_s(\rho) = \left[\frac{1}{c_0} - \frac{\phi(\rho)}{360fD} \right]^{-1} \quad (7)$$

- where $\phi(\rho)$ is the measured phase shift as a function of density. A polynomial fit as
 10 shown in Eq. (5) is used by the controller 20 to find the speed of sound values. For the three layer model, two sound speeds are calculated. These two speeds are the speed c_i for the trabecular layers and the speed c_{ii} of the cortical (central) bone. Given the thicknesses D_1 , D_2 , and D_3 , respectively, for the three bone layers 50, 52, 54, the speed c_{ii} of the cortical layer is fit by the controller 20 as a function of density according to:

$$15 \quad c_i(\rho) = (d_1 + d_3) \left[\frac{d_1 + d_2 + d_3}{c_0} - \frac{d_2}{c_{ii}} - \frac{\phi(\rho)}{360fD} \right]^{-1}. \quad (8)$$

The polynomial fit for $c_i(\rho)$ is performed using Eq. (5) over a series of trial functions for c_{ii} . The final sound speeds are the $c_i(\rho)$ and $c_{ii}(\rho)$ that most closely correlate by standard deviation or other methods with direct skull measurements obtained by fitting a large skull sample.

Referring to FIGS. 1 and 3, in operation, the controller 20 uses information from the imager 12 to adjust the phase of the transducer elements 16. At stage 60, the imager 12 takes images of the patient's skull 28. This may be done remotely in space, e.g., in another hospital, from the controller 20. At stage 62, the imager transmits information, e.g., intensities of portions of the image, related to skull thickness, density, and structure to the controller 20. This transmission can be separated in time from when the imager 12 takes the image and can also be performed by human intervention, e.g., by recording the images on a CD and replaying the CD in the controller 20. At stage 64, the controller 20 manipulates this information to determine thicknesses of layers, and to identify the layers, of the patient's skull 28 by analyzing intensities of portions of the image. At stage 66, the controller 20 determines excitation correction factors such as the phase shift factors α_1 - α_n (or amplitude corrections as discussed below) and transmits the phase shift factors α_1 - α_n to the adjuster 18. At stage 68, the frequency generator supplies energy to the adjuster 18. The adjuster 18 adjusts the phase of the energy from the frequency generator 22 according to the phase shift factors α_1 - α_n from the controller 20. The adjusted energies are sent to the transducer elements 16 that convert the energies into ultrasound waves and transmit these waves into the patient's skull 28. Images from the imager 12 can be supplied in real time and the amplitude and/or phasing of the energy applied to the patient changed in response to the images.

The power supplied to the patient's skull 28 depends on the type of therapy. For ablation, approximately 2-3 kW for approximately 10 seconds using 64 transducer

elements may be used. If more transducer elements 16 are used, then less total power may be used and vice versa. For opening the blood-brain barrier, about 100 times less power than for ablation may be used due to preformed gas bubbles in the area of interest.

The ablation power can also be reduced by the preformed gas bubbles. Using bursts of
5 energy has been found to reduce, if not eliminate, effects on phase due to standing waves that may occur if the transducer elements 16 constantly emit energy.

Other embodiments are within the scope and spirit of the appended claims. For example, the array 14 of transducer elements 16 shown in FIG. 1 may contain fewer transducer elements 16 than shown. The phase shift factors α_1 - α_n may be pre-stored in
10 the channels of signal adjuster 18 instead of being provided by the controller 20. Further, functions described as being performed by the controller 20 could be performed by the imager 12 and vice versa, or by a person using the system 10, e.g., calculating densities and providing input data to the controller 20 regarding phase shift factors α_1 - α_n .

Referring to FIGS. 4-5, a noninvasive process 70 for obtaining phase shift factors
15 α_1 - α_n using a system 90 operates the transducer elements 16 in both transmit and receive modes. In the system 90, a controller 92 is similar to the controller 20 (FIG. 1), but is also configured to control switches 94₁-94_n such that the transducer elements 16 are connected to the controller 92 in a receive mode and to the adjuster 18 in a transmit mode.

20 At stage 72, the controller 92 controls the switches 94 to be positioned such that one switch, e.g., switch 94₁, is in the transmit mode. The frequency generator 22

produces a low-frequency ultrasound wave train of about 5-30 cycles. Some of this wave train reflects off of the skull 28 and some of the wave train passes through the skull 28 into the patient's brain.

At stage 74, the controller 92 causes the switch 94₁ to switch into the receive
5 mode, connecting the transducer element 16₁ to the controller 92. The wave train reflects off of the skull 28 and reflections are received by the transducer element 16₁ and recorded by the controller 92. The propagation speeds and the pulse train lengths are such that energy from a pulse train is still being transmitted into, and reflected by, the outer surface of the skull 28 when energy from that pulse train that was reflected by the inner surface of
10 the skull 28 passes through the skull 28 toward the array 14. Thus, the received reflections of the inner and outer surfaces are superimposed.

At stage 76, a query is made as to whether a series of frequencies to be transmitted has been completed. If not, then the process 70 returns to stage 72 to transmit a different frequency in the series. If the series has been completed, with corresponding recorded
15 amplitude data as a function of frequency, then the process 70 proceeds to stage 78.

At stage 78, the controller 92 analyzes and processes the recorded information to determine the phase shift factors α_1 - α_n . The controller 92 deconvolves the recorded frequency response that includes the superimposed reflections from the interfaces at the inner and outer surfaces of the skull. The superimposed reflections produce a periodic
20 appearance of local maxima and minima in the data as a function of frequency. Information from images, e.g., CT or MRI images, are used by the controller 92 to

determine the locations of the inner and outer surfaces, and thus the skull thickness. The controller 92 estimates the phase shift ($\Delta\phi$) using the distance, Δf , between like extrema, e.g., peaks, according to:

$$\Delta\phi = 2\pi f [(d/c_0) - (1/(2\Delta f))] \quad (9)$$

5 where f is a frequency to be transmitted for which the phase correction is to be used, d is the skull thickness determined from the image, and c_0 is the speed of sound in water. Adjustments may be made to this phase shift using density correction techniques. The process 70 is repeated for the remainder of the transducer elements 16.

Phase shifts and acoustic attenuation due to transskull sonication can also be
10 determined from analysis of CT images. For purposes of determining phase shift and acoustic attenuation, it can be assumed that there is essentially a one-to-one correlation between x-ray attenuation coefficient μ and the speed of sound c in bone and between μ and acoustic attenuation.

Equations relating x-ray attenuation to phase and acoustic attenuation have been
15 developed as discussed below, with the equations including parameters determined from fitting to experimental data. Experimental data has been determined by applying ultrasound to a pig skull sample using a 1" transducer element made by Panametrics of Waltham, Massachusetts, operating at 730 kHz and positioned about 7 cm from a 0.6mm hydrophone. The skull was attached to a 3-D positioning system and the transducer
20 element was driven by a 10-cycle sinusoid signal produced by a waveform generator such as a Wavetek model 395 made by Wavetek Ltd. of Norwich, United Kingdom, or a

waveform generator made by, e.g., Fluke Corporation of Everett, Washington. The hydrophone response was recorded on an HP54602 digital oscilloscope made by Hewlett Packard of Palo Alto, CA. Measurements of the skull sample were obtained by immersing the sample in water and using dual-slice spiral acquisition with 0.5 mm slices.

- 5 Phase shift through the skull can be related to x-ray attenuation by assuming a formulaic relationship and fitting actual data to the formula. The x-ray attenuation coefficient μ is related to the CT number CT_n according to:

$$\mu = k (CT_n + 1,000) \quad (10)$$

where k is a well-known physical constant. The units of μ may be chosen such that $k=1$.

- 10 The phase shift due to the passage through the bone is given by:

$$\Delta\phi = 2\pi f \int (1/c(x) - 1/c_0) dx \quad (11)$$

where f is the frequency, $c(x)$ is the speed of sound at point x and c_0 the speed of sound in water (or soft tissue, that is practically the same). The integration in Eq. 11 is performed along the line of propagation of the ultrasound energy. The functional dependence on μ is

- 15 assumed to be:

$$1/c(x) = A' + B'(1/\mu(x)) + C'(1/\mu(x))^2 \quad (12)$$

where A' , B' and C' are parameters fitted to the experimental data determined from experiments using the setup described above. Approximations other than that shown in Eq. 12 may be used. From Eqs. 11 and 12:

- 20
$$\Delta\phi = A(p_2 - p_1 + 1) + B \sum (1/\mu(x)) + C \sum (1/\mu(x))^2 \quad (13)$$

where $A = 2\pi f(A' - 1/c_0)$, $B = 2\pi fB'$, $C = 2\pi fC'$, and p_2, p_1 are the first and last pixels

within the bone along the line of propagation and the sums are performed within these boundaries. The values of p_2 , p_1 are obtained manually from intensity profiles drawn along the lines of propagation. These values may also be obtained automatically using well-known edge-detection techniques.

5 The equation for $\Delta\phi$ can be modified to include a thickness-independent parameter. Thus, Eq. 13 can be modified to:

$$\Delta\phi = A(p_2-p_1+1) + B\Sigma (1/\mu(x)) + C\Sigma (1/\mu(x))^2 + J \quad (14)$$

where J is the phase shift at zero thickness and its non-zero value is probably due to experimental error. The value of $\Delta\phi$ can be used to adjust the phases of elements of an
10 array of transducer elements such as the array 14 of the system 10 shown in FIG. 1.

From experiments using the setup described above, exemplary values of the parameters A , B , C , and J were obtained. These values were $A=0.1126$, $B=-0.0610$, $C=-0.0759$, and $J=-0.1375$. Using these values in Eq. 14 yielded superior results (e.g., a standard deviation of 21°) when compared to $\Delta\phi = 2\pi fx (1/c_b - 1/c_0)$ and assuming $c_b =$
15 2650 m/sec and $c_0 = 1500$ m/sec (e.g., a standard deviation of 54°).

Acoustic attenuation through the skull can also be related to x-ray attenuation by assuming a formulaic relationship and fitting actual data to the formula. The acoustic attenuation through bone is given by:

$$\ln(I/I_0) = - \int \mu_{AC}(x) dx \quad (15)$$

20 Where I and I_0 are the acoustic intensities before and after the passage through the bone respectively and $\mu_{AC}(x)$ is the local acoustic attenuation coefficient. The relation

between the acoustic and x-ray attenuation coefficients can be approximated as:

$$\mu_{AC}(x) = E + F \mu(x) + G(\mu(x))^2 \quad (16)$$

Approximations other than that shown in Eq. 16 may also be used. Integrating over the set of pixels along the line of propagation, as explained above, yields:

$$5 \quad -\ln(I/I_0) = E(p_2 - p_1 + 1) + F \Sigma \mu(x) + G \Sigma (\mu(x))^2 + H \quad (17)$$

where H is a thickness-independent parameter that reflects the fraction of the intensity reflected at the interfaces (air-to-skull, between skull layers, and skull-to-brain). Again, from experimental results using the setup discussed above, acceptable values for the parameters E, F, G, and H were determined to be E= 0.7552, F= -0.9007, G= 0.2946, and
 10 H= -0.9121. Using information about the acoustic attenuation, the magnitude of transmitted energy can be adjusted using the amplifiers 24 based on signals from the controller 20.

In operation, the imager 12 supplies the CT numbers of images to the controller 20 that uses the CT numbers and the experimentally-determined values for A, B, C, J, E,
 15 F, G, & H to determine the phase correction factors $\alpha_1 - \alpha_n$ and amplitude adjustment factors for the amplifiers 24. The system otherwise operates generally as described above, with the adjuster 18 adjusting phase and amplitude of energy from the generator 22 as indicated by the controller 20.

Still further embodiments are within the scope and spirit of the appended claims.
 20 For example, while the above discussion focused on ultrasound energy transmitted through human skulls, other frequencies of energy and other subjects may be used, and

other areas of subjects may be targeted for receiving energy. For example, non-human subjects are acceptable, as well as transmitting energy into areas of human or non-human subjects aside from through the skull and into the brain. Also, other techniques for determining and/or controlling the phase and amplitude of signals transmitted into the patient 30 may be used. For example, techniques that may be used include those of concurrently-filed U.S. Patent Application Ser. No. [Not Yet Assigned, filed November 28, 2000; Attorney Docket Number 254/187] entitled "SYSTEMS AND METHODS FOR FOCUSING AN ACOUSTIC ENERGY BEAM TRANSMITTED THROUGH A SKULL," and concurrently-filed U.S. Patent Application Ser. No. [Not Yet Assigned, filed November 28, 2000; Attorney Docket Number 254/189] entitled "SYSTEMS AND METHODS FOR CONTROLLING A PHASED ARRAY FOCUSED ULTRASOUND SYSTEM," both of which are incorporated here by reference.

Further embodiments are also within the scope and spirit of the invention. For example, the system 10 shown in FIG. 1 can be configured to apply a projection algorithm to identify phase and/or amplitude adjustments to be applied by the amplifiers 24 and/or the phase shifters 26. The algorithm is based on a layered wavevector-frequency domain model that propagates ultrasound from a hemispherical transducer array through the skull 28 and uses input from CT scans of the skull 28. The projection algorithm, that the controller 20 is configured to perform, calculates driving phases and/or amplitudes for each transducer 16 in the array 14 to improve, and possibly maximize, the signal at an intended focus. Experimental results have shown that this technique can be

used for completely non-invasive ultrasound brain therapy, including surgery.

The projection algorithm as implemented by the system 10, and especially the controller 20, concentrates on a noninvasive focusing method that uses CT images to predict how the ultrasound will propagate through the skull 28. The algorithm predicts the behavior of the ultrasound field after passing through the skull bone 28, which causes significant reflection, diffraction and absorption of the field. To implement the algorithm, the system 10 accurately obtains knowledge of the thickness and internal structure of the skull bone 28 and achieves precise registration between the skull 28 and the ultrasound array 14. The algorithm provides a relatively uncomplicated, computationally-feasible mechanism for determining phase and/or amplitude corrections without oversimplification.

The projection algorithm uses thickness, density, and orientation information obtained from CT images of the head 28. This information is entered into a propagation model that can propagate ultrasound through arbitrarily oriented (non parallel) layers. Operating in the wavevector-frequency domain, this model rapidly propagates sections of the ultrasound field through the skull 28. Two specialized cases of the model are examined for the present focusing algorithm. The first case propagates ultrasound through the skull 28 with normal incidence, and assuming that the skull is homogeneous. The second case considers the angle between the skull surface and the incident acoustic field. Both of these models have been tested using *ex vivo* human skulls and hydrophone measurements in a water bath.

The Projection Algorithm

A projection algorithm in the wavevector-frequency domain is used to determine propagation through the skull 28 and correction factors for the ultrasound array

- 5 transducers 16. The projection algorithm assumes that the acoustic field satisfies the linearized Stoke's equation,

$$\left(1 + \tau \frac{\partial}{\partial t}\right) \nabla^2 p(\vec{r}, t) = \frac{1}{c^2} \ddot{p}(\vec{r}, t), \quad (18)$$

where τ is the relaxation constant for the medium and c is the real sound speed. While therapeutic arrays operate at high powers, the linear approximation is found to be

- 10 appropriate for propagation outside of the focus. A Helmholtz equation in Cartesian coordinates is obtained by the substitution of the Fourier integral

$$\tilde{P}(\vec{r}, t) = \frac{1}{\sqrt[3]{2\pi}} \iiint \tilde{p}(k_x, k_y, z, \omega) e^{ik_x x} e^{ik_y y} e^{i\omega t} dk_x dk_y d\omega \quad (19)$$

into Eq (18), where the Cartesian wavenumbers are given by k_x and k_y and ω is the angular frequency. The resulting equation,

$$15 \quad (\nabla^2 + \tilde{k}^2) \tilde{p}(k_x, k_y, z, \omega) = 0, \quad (20)$$

is expressed in terms of a complex wavenumber \tilde{k} given by

$$\tilde{k} = \sqrt{\frac{\omega^2}{c^2} \frac{1}{1 + i\tau\omega} - k_x^2 - k_y^2}. \quad (21)$$

To propagate the field in a plane at a distance z_0 in front of a source to a new plane z , the advanced solution of Eq. (20) is used:

$$\tilde{p}(\vec{k}, z) = \tilde{p}(\vec{k}, z_0) e^{i\vec{k}(z-z_0)} \quad (22)$$

In wavevector space, the field recorded in a plane z_0 is thus related to the field at any other plane z by a simple transfer function given in the right hand side of Eq. (22). The pressure field in space at z may be obtained by taking the inverse Fourier transform of the
5 equation.

Propagation in wavevector space can be performed using Eq. (22) after the spatial Fourier transform of the field is calculated for a given plane. This planar cross section of the field, z_0 , is chosen to be planar and perpendicular to the propagation axis. The field can be projected to an arbitrary new plane z . The array 14 is sectioned into small areas
10 that are individually propagated through the skull 28 in a manner that, as described below, yields more easily in Cartesian space. The controller 20 divides the array 14 into segments equal to the array's transducer elements (e.g., 280 mm²), although this does not have to be the case. For example, a large element could be segmented into several smaller elements.

15 The controller 20 calculates the acoustic pressure in water due to each segment over a plane located directly above the skull's outer surface. Using the backward projection approach, the controller 20 first calculates the field of each transducer element 16 at the transducer's geometric focus in water. The field at the focus is calculated using the Rayleigh-Somerfeld integral,

$$20 \quad p_n(\vec{r}, t) = \frac{i\omega\rho}{4\pi} \iint \frac{e^{i(\omega t - k|\vec{r} - \vec{r}'|)}}{|\vec{r} - \vec{r}'|} \vec{v}(\vec{r}') \cdot d\vec{S}'_n \quad (23)$$

over a planar area 20mm x 20mm perpendicular to the geometric center of the transducer

16. A water sound speed of $c = 1488$ m/s and density of $\rho = 1000$ kg/m³ is used along with a normalized surface displacement velocity \bar{v} . The controller 20 preferably calculates this field only once for a particular transducer, and uses it repeatedly.

- 5 Alternatively, the effects of imperfections on the array could be added by replacing Eq. (23) with physical measurements of the field over this area for each element 16 in the array 14.

The field due to the n -th element is Fourier transformed by the controller 20 giving a planar field $\tilde{p}(k_x, k_y, \omega, z_o)$. This planar field is rotated in the wavevector-
 10 frequency domain, defining a new projection plane, z_o' . Referring to FIG. 6, the spatial Fourier transform method, sometimes referred to as the angular spectrum approach, may be viewed as an angular decomposition of the field. That is, each point describes a planar wave with frequency ω passing through the measurement plane at an angle equal to
 $\alpha_x = \sin^{-1} k_x \frac{c}{\omega}$ from the z -axis in the x - z plane and $\alpha_y = \sin^{-1} k_y \frac{c}{\omega}$ in the y - z plane. The
 15 amplitude of the wave is equal to the modulus of \tilde{p} . FIG. 6 illustrates this concept for a two-dimensional case. In three dimensions, the propagation angles may be expressed in terms of a polar angle θ and azimuthal angle ϕ :

$$\begin{aligned} \tan \alpha_x &= \tan \theta \cos \phi \\ \tan \alpha_y &= \tan \theta \sin \phi \end{aligned} \quad (24)$$

For a transient signal, each temporal frequency possesses a unique angular spectrum,
 20 forming a three-dimensional space consisting of two spatial frequency dimensions and

one temporal frequency dimension. The tested signals are harmonic and may be expressed in two dimensions.

Viewing the wavevector plane as an angular decomposition, to the controller 20 can perform a passive coordinate rotation. To orient the plane along a new projection
5 axis, z'_o , each point \vec{p} in wavevector space is mapped to the rotated plane such that:

$$\begin{aligned} k_x &\Rightarrow k'_x = \frac{\omega}{c} \sin(\alpha_x - \alpha_x^{ROT}) \\ k_y &\Rightarrow k'_y = \frac{\omega}{c} \sin(\alpha_y - \alpha_y^{ROT}) \end{aligned} \quad (25)$$

where α_x^{ROT} is the rotation angle in the x-z plane and α_y^{ROT} is the rotation angle in the y-z plane. These angles are be obtained by inverting the polar and azimuthal orientation of the element using Eq. (24). Projection along the new axis to an arbitrary new plane z' is
10 achieved using Eq. (22). The inverse Fourier transform performed after this mapping provides the pressure field in the plane rotated to $(\theta^{ROT}, \phi^{ROT})$, where the spherical polar angles are related to α_x^{ROT} and α_y^{ROT} by Eq. (24). Transskull propagation begins by projecting to the rotated plane at z'_o to the plane z' directly above the skull's outer surface.

For the physical array 14, where the exact orientation (θ, ϕ) of the elements 16 is
15 not known *a priori*, the projection approach will yield their locations. The controller 20 obtains the angles directly from the Fourier transform of the pressure field, taking angles associated with the maximum amplitude of $\vec{p}(k_x, k_y, \omega, z_o)$ as the propagation axis.

Propagation through layered media in wavevector space can be achieved by

determining exactly how the layers distort each point in the space. For an arbitrary field incident upon a series of planar layers, each wavevector component over the plane at z_0 is associated with a wavevector $\vec{k}_{0,xy}(\omega) = k_x(\omega)\hat{i} + k_y(\omega)\hat{j}$, where the indices (x,y) indicate the position of the component in k-space. The angle of incidence between a given

5 wavevector and the vector normal to the outer surface of the n^{th} layer is given by $\gamma_{i,xy}(\omega)$, and the transmitted angle by $\gamma_{t,xy}(\omega)$. For a layer with sound speeds c_n and density ρ_n , the pressure transmission coefficient at its lower interface is given by

$$T_{nxy}(\omega) = \frac{2\rho_{n+1}c_{n+1}\cos\gamma_{i,xy}\cos\gamma_{t,xy}}{\rho_n c_n \cos\gamma_{t,xy} + \rho_{n+1}c_{n+1}\cos\gamma_{i,xy}}, \quad (26)$$

where the incident and transmitted angles γ_i, γ_t are understood to be a function of

10 frequency. Since the problem has been decomposed into a series of plane waves, transmission of the field from the outer surface to the next layer may be treated either by using a ray method, or by applying the continuity of the pressure and normal particle velocity at the interface. The ray method is described below in detail, as it leads to the

15 general case of propagation through non-parallel layers. In this first-order propagation, multiple reflections within the layers are neglected, although such higher order reflections could readily be added.

Regardless of whether or not the layers are parallel, the transfer function may readily be written in a closed form. In addition to the thickness across the z-axis, z_n , the sound speed c_n , and density of each layer ρ_n , the unit vectors normal to the layer surfaces

20 \hat{n}_n are calculated. For a given initial wavevector $\vec{k}_{0,xy}$, the ray path from $(0,0, z_0)$ between

any two surface interfaces traverses a distance of

$$|\vec{R}_{nxy}| = \frac{(\vec{z}_{nxy} - \vec{r}_{nxy}) \cdot \hat{n}_{n+1}}{\hat{k}_{nxy} \cdot \hat{n}_{n+1}}, \quad (27)$$

where, as depicted in FIG. 7, \vec{r}_{nxy} is the vector extending along the layer from z-axis to the intercept of the layer with the ray. The unit vector along the wavevector's path is given

5 by \hat{k}_{nxy} . Again, the frequency dependence on the wavevector orientation is understood.

It follows that the ray position vector is $\vec{R}_{nxy} = |\vec{R}_{nxy}| \hat{k}_{nxy}$. Although the initial wavevector orientation, \hat{k}_{0xy} , is known, the direction of the wave vector in the first and subsequent layers is calculated using the relation

$$\frac{1}{c_n} (\hat{n}_{n+1} \times \hat{k}_{nxy}) = \frac{1}{c_{n+1}} (\hat{n}_{n+1} \times \hat{k}_{n+1xy}), \quad (28)$$

10 which is a consequence of Snell's law in three dimensional space in which the incident wavevector, the transmitted wavevector and the normal vector all be in the same plane. The transmitted wavevector on the right hand side of Eq. (28) may be obtained by crossing both sides of the equation with \hat{n}_{n+1} . Using cross product relations, it may be shown that

$$15 \quad \hat{k}_{n+1xy} = \frac{c_{n+1}}{c_n} (\hat{k}_{nxy} - \cos \gamma_{i_{n+1xy}} \hat{n}_{n+1}) + \cos \gamma_{i_{n+1xy}} \hat{n}_{n+1} \quad (29)$$

The incident unit wavevector of the nth layer is equal to the transmitted wave of the (n-1)st layer. With the exception of the 0th layer shown in FIG. 7, \vec{r}_{nxy} is also found in order to calculate Eq. (27). Given the thickness across the z-axis of each layer, the point of

intersection of ray \vec{R}_n with the surface of the n+1 layer is

$$\vec{r}_{n+1} = \vec{R}_n + \vec{r}_n - \vec{z}_n. \quad (30)$$

Over a series of N layers, the phase of a ray reaching the Nth plane $\phi_R(\vec{k}_{Nxy}, \omega)$ is the sum of the phase contributions over each path length given by Eq. (27). The spatial phase at the plane z, is related to the ray phase at N by

$\phi_N(\vec{k}_{Nxy}, \omega) = \phi_R(\vec{k}_{Nxy}, \omega) - 2\pi k_N r_N \sin \gamma_{Nxy}$, as illustrated in FIG. 7. A ray leaving the initial plane with a polar angle $\gamma_{0xy}(\omega)$ will arrive at the plane z with a new orientation $\gamma_{Nxy}(\omega)$ determined by the N-1 unit vector \hat{k}_{N-1} . The spatial phase at plane z is related to the spatial phase at plane z_0 by

$$10 \quad \phi(\vec{k}_{Nxy}, \omega, z) = \phi(\vec{k}_{0xy}, \omega, z_0) + \sum_{n=0}^{N-1} k_n \frac{(\vec{z}_n - \vec{r}_n) \cdot \hat{n}_{n+1}}{\hat{k}_n \cdot \hat{n}_{n+1}} - \sin \gamma_{Nxy}(\omega), \quad (31)$$

given $\phi(\vec{k}_{0xy}, \omega, z_0)$, the phase of $\tilde{p}(k_x, k_y, \omega, z_0)$ at the initial plane.

The pressure over the plane at z can be expressed in terms of the ray phase presented in Eq. (31) and the transmission coefficient in Eq. (26) by

$$15 \quad \tilde{p}(\vec{k}_{Nxy}, \omega, z) = \tilde{p}(\vec{k}_{0xy}, \omega, z_0) e^{-i \sin \gamma_{Nxy}(\omega)} \left[\prod_{n=1}^{N-1} T_{nxy}(\omega) e^{i \phi_N(\vec{k}_{Nxy}, \omega, z)} \right], \quad (32)$$

where the terms in square brackets on the left hand side of Eq. (32) can be viewed as an operator that maps the field from k_0 -space to a new k_N -space. In practice, this mapping uses interpolation to produce a linearly spaced matrix at z.

Non-Planar Surfaces

The layered-projection method may be used for the propagation of a field through a curved surface, provided the surface is sufficiently smooth relative to the highest relevant wavenumber. The field is projected to a plane near the surface and is divided

5 into a series of virtual sources. The region of the surface penetrated by a given source is approximated as planar, with the actual surface over the beamwidth of the source preferably agreeing with this approximation to at least within $\frac{1}{4}$ of the maximum frequency k_{\max} . At the same time the source diameter S is preferably large enough that the smaller frequency components of the source are in the near field relative to the

10 Rayleigh distance, with $S > \sqrt{\frac{z}{2k_{\min}}}$, where k_{\min} is the smallest appreciable frequency of the signal and z is the distance from the starting plane to the surface. Although the planar field is uniquely divided into a continuous series of sources, the fields of the sources will overlap on the surface.

When propagating through multiple layers, each of the surfaces is segmented as

15 described above. It is possible that components with high transmission angles will leave the surface of interest.

Thus, multiple layers of the skull 28 can be taken into account by determining the transmission angle through each layer, using this angle and layer thickness and orientation (and the next layer's orientation) to determine length of propagation through the layer,

20 and applying the density to determine phase and attenuation (as discussed below) through each layer based on the propagation length through each layer.

Registration of Images and Array

Standard techniques may be used to register the array 14 and images of the skull 28. Registering the array 14 and the images helps to ensure that the proper focal point for the ultrasound is achieved. Proper registration helps ensure that the proper portion of the skull 28 is being analyzed to yield the accurate thicknesses, densities, orientations (e.g., incident angles), and locations of layers of the skull 28 between the array 14 and the desired focal point within the skull 28. With accurate measurements, the controller 20 can determine accurate phase and amplitude corrections for the amplifiers 24 and the phase shifters 26 to focus ultrasound from the array 14 at a desired location inside the skull 28. Standard techniques for registering the array 14 and the skull images include using a reference frame that attaches to the array 14 and to the skull 28 and that has reference markers that can be identified in CT and MR images. The reference markers can be used to rotate CT and MR images to register the images (with CT images yielding bone characteristics, while MR images may be used during therapy due to better soft-tissue resolution). Alternatively, one or both of the CT and MR images may be rotated until they match. Other techniques that yield registration so that the array's orientation relative to the skull 28 can be determined are also acceptable.

20 Skull Sound Speed

Based on a study of over 1000 measurements performed with 10 skulls using a

0.51 MHz transducer, a linear fit of sound speed as a function of skull density was obtained. A first-order (linear) fit obtained using Eq. (22) yields the equation:

$$c_{\text{eff}} = 2.06 \frac{\text{m}^4}{\text{s} \cdot \text{kg}} \rho - 1.54 \times 10^3 \frac{\text{m}}{\text{s}} \quad (33)$$

in MKS units over the range of thickness-averaged densities between $1.82 \times 10^3 \text{ kg/m}^3$ and $2.45 \times 10^3 \text{ kg/m}^3$. Density measurements obtained by analyzing the CT images are input to Eq. (33) to provide the effective skull sound speed values in the focusing algorithm. Eq. (33) is exemplary only, and not limiting. Eq. (33) is based on experimental data, and thus dependent on the acquired data. Further, other relationships of sound speed and density are possible, and acceptable, including other linear data fits. Also, other fits, e.g., non-linear fits, of sound speed as a function of skull density may be used.

Skull Attenuation

Experimental data can be, and has been, used to determine a relationship between ultrasound attenuation and skull density. It was found that attenuation increases as the frequency increases and generally decreases nonlinearly as the density increases. Further, the relationship of attenuation and density has a minimum and a slightly increasing attenuation when the density increases beyond approximately 2000 kg/m^3 .

Focusing Algorithm

To produce a focus through the skull, the acoustic pressure is calculated by the

controller 20 at the intended focal point for each element 16 after propagation through the skull 28. The controller 20 can perform its calculations under at least two different scenarios. In the first case (Case 1), the controller 20 ignores incident angles and assumes the ultrasound is normally incident upon the skull 28. In the second case (Case 2), the controller 20 uses the incident angle γ_i determined from Eq. (26) over the skull surface to include incidence in the model. The pressure phase is compared with the phase expected if the skull 28 were not present. The change in phase caused by the skull 28 is recorded and used for correcting the driving phase of the transducer array 14. The driving phase of each element 16 is adjusted by an amount

$$10 \quad \Delta\phi = \arg(P(r)/P_0(r)), \quad (34)$$

where P is the acoustic pressure at the point in the skull 28 and P_0 is the acoustic pressure expected at the same point if the skull 28 were not present. Similarly, a large element 16 could be divided into M sections for propagation, with the driving phase is adjusted by

$$15 \quad \Delta\phi = \arg\left(\sum_{m=1}^M P_m(r)/P_0(r)\right). \quad (35)$$

15

Operation of the system 10 implementing the spectral wavevector algorithm proceeds similarly to the process shown in FIG. 3. The imager 12 takes a CT image of the skull 28. From this image, the controller 20 determines locations, orientations, thicknesses, and densities of layer portions between respective array elements 16 and a desired focal point inside the skull 28. The controller 20 can assume that the skull 28 is a

20

single layer or can take into account different skull layers. From the determined skull data, the controller 20 determines lengths traveled by ultrasound from the elements 16 through the skull 28 toward the focal point. The controller 20 applies relationships of phase and amplitude to density, either taking into account incident angles or assuming
5 planar propagation. The controller 20 thus determines propagation speed and attenuation (e.g., using Eq. (33) for propagation speed and an experimentally-derived relationship for attenuation) through the skull 28, and from these data and length traveled through the skull 28 determines the phase and amplitude deltas for each array element 16. With these deltas, the controller 20 determines phase and amplitude correction factors to be applied
10 by the phase shifters 26 and the amplifiers 24 to yield focused ultrasound at a desired location inside the skull 28.

Experimental Data

The entire projection algorithm was implemented in Matlab, on a series of
15 Pentium and AMD-based computers over an NT network. A typical processing time for producing a focus within the skull 28 for 320 elements 16 using a 1 GHz machine with 256 MB of RAM was approximately five hours.

The focusing method was tested on ten Formalin fixed *ex vivo* human skulls. Acoustic properties of the fixed skulls are assumed to be similar to fresh skulls. CT
20 Images of the skulls were obtained and used in the focusing algorithm, treating the skull bone as homogeneous, so that in Eq. (31) $N=3$. Although the wavevector method is

capable of compensating for both the magnitude and phase of the driving signal, only phase correction was considered. The transducer array was a 30-cm-diameter, 0.74 MHz hemisphere divided into 500 individual elements. Only the lower 320 elements of the array were used for the measurements in order to allow a larger range in the movement of the skull. A reference frame was attached to the skull to assist with registration of the array and the skull. A hydrophone was placed inside the skull to measure the ultrasound inside the skull from the array.

For the 10 skulls, the peak signal without phase correction was found to occur at a mean distance of 1.1 mm from the intended focal location with values ranging from 0.45 mm to 2.5 mm and a standard deviation (STD) of 0.64 mm. In 7 of the 10 cases studied, the main focus was scattered into two or more foci, so the peak signal refers to that of the largest (larger) focus. When the phasing algorithm was used, a single focus was always produced, regardless of whether the incident angle was considered. When the phasing algorithm was applied without correction for incident angle, the mean distance from the peak was reduced to 0.59 mm with values ranging from 0.22 mm to 1.1 mm and a STD of 0.26 mm. With the angle of incidence included in the algorithm, the mean distance was further reduced to 0.48 mm over a range of distances from 0.20 mm to 0.82 mm and a STD of 0.22 mm.

Peak voltage-response-squared measurements were also observed to improve with the phasing algorithm. Without phasing, the average peak was found to be 34 % of the value obtained by the invasive hydrophone-phasing technique with a variation from 14 %

to 58 % over the samples. The lower amplitudes corresponded to skulls that scattered the field into multiple foci. The phasing algorithm, without correction for incident angle, improved the peak value on average to 46% of the hydrophone-phased signal with a range between 22% and 58%. When the incident angle was included, the average value was
5 45% with a range from 29% to 59%. The peak values between the two models were, on average, similar. However, the variance was reduced when incident angles were included.

Both models significantly improved the ratio between the peak amplitude and the largest secondary lobes. To assure all secondary lobes were taken into account, values
10 were obtained from searching within the 512 mm³ volume obtained using the harmonic projection technique. Without phase correction the secondary peak amplitude averaged 63% of the primary peak. Using the correction algorithm, secondary peaks averaged 29% without angle correction and 32% with the angle included.

Still further embodiments are within the scope and spirit of the invention and the
15 appended claims.

What is claimed is:

CLAIMS

1. A method of delivering ultrasound signals, the method comprising:
providing an image of at least a portion of a subject intended to receive ultrasound
5 signals between sources of the ultrasound signals and a desired region of the subject for
receiving focused ultrasound signals;
identifying, from the image, physical characteristics of portions of material
between the sources and the desired region; and
using a spectral propagation analysis to determine at least one of phase corrections
10 and amplitude corrections for the sources depending on the respective physical
characteristics of the portions of the material disposed between each source and the
desired region.
2. The method of claim 1 wherein the physical characteristics include density
15 and thickness.
3. The method of claim 1 wherein the identifying identifies the physical
characteristics of different layers of the portions of the material.
- 20 4. The method of claim 3 wherein the physical characteristics include angle
of a layer interface relative to a reference.

5. The method of claim 1 wherein the spectral propagation analysis includes a wavevector-frequency domain projection algorithm.

6. The method of claim 5 wherein the using includes comparing projected
5 phases from the sources to the desired region accounting for the material and ignoring the material.

7. The method of claim 6 wherein the using assumes perpendicular incidence
of ultrasound.

10

8. The method of claim 6 further comprising determining an incident angle
of ultrasound to the material.

9. The method of claim 8 wherein the identifying identifies the physical
15 characteristics of different layers of the portions of the material and the determining an incident angle determines incident angles for each layer of the material.

10. A system for delivering ultrasound signals, the system comprising:
an apparatus configured to analyze an image of at least a portion of a subject
20 intended to receive ultrasound signals between sources of the ultrasound signals and a desired region of the subject for receiving focused ultrasound signals, the apparatus

configured to determine, from the image using a spectral projection analysis, information about the at least a portion of the subject; and

an array of sources of ultrasound signals having at least respective ones of their relative phases and their amplitudes set in accordance with the information about the at
5 least a portion of the subject provided by the apparatus.

11. The system of claim 10 wherein the apparatus comprises means for identifying physical characteristics of multiple layers of the portion of the subject, the physical characteristics including density and thickness.

10

12. The system of claim 11 wherein the physical characteristics further include incident angles of the layers relative to respective sources, the apparatus further comprising means for comparing projected phases of the signals from the sources to the desired region accounting for the portion of the subject and ignoring the portion of the
15 subject.

13. The system of claim 10 wherein the apparatus comprises means for performing a wavevector-frequency domain projection algorithm.

14. A computer program product residing on a computer readable medium and comprising computer-readable, computer executable instructions for causing a computer to:

analyze an image of at least a portion of a subject to receive ultrasound signals
5 between sources of the ultrasound signals and a desired region of the subject for receiving
focused ultrasound signals to identify, from the image, physical characteristics of
respective portions of material between the sources and the desired region; and
determine, using a wavevector-frequency domain projection algorithm, at least
one of phase corrections and amplitude corrections for the sources depending on
10 respective physical characteristics of portions of the material disposed between each
source and the desired region.

15. The computer program product of claim 14 wherein the physical characteristics include density and thickness.

16. The computer program product of claim 14 wherein the instructions for causing the computer to analyze cause the computer to identify the physical characteristics of different layers of the portions of the material.

20. 17. The computer program product of claim 16 wherein the physical characteristics include angles of layer interfaces relative to the sources.

18. The computer program product of claim 14 wherein the instructions for causing the computer to analyze cause the computer to compare projected phases from the sources to the desired region accounting for the portions of the material and ignoring
5 the portions of the material.

19. The computer program product of claim 18 further comprising instructions for causing the computer to determine the projected phases accounting for the portions of the material assuming perpendicular incidence of ultrasound.
10

20. The computer program product of claim 18 further comprising instructions for causing the computer to determine the projected phases accounting for the portions of the material by determining and using incident angles of ultrasound relative to the layers of the portions of the material.
15

21. The computer program product of claim 21 wherein the instructions for causing the computer to determine incident angles cause the computer to determine incident angles for each layer of the portions of the material.

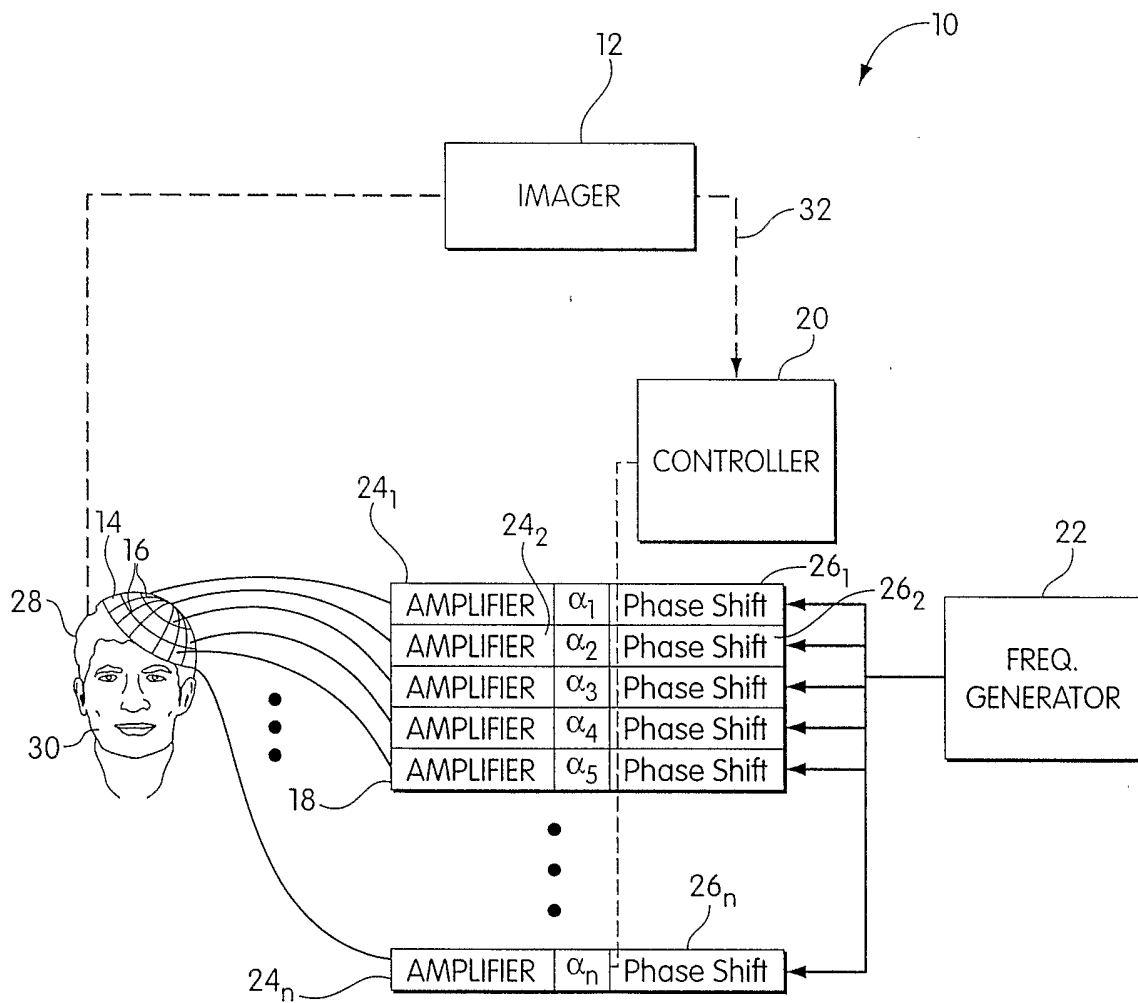

Fig. 1

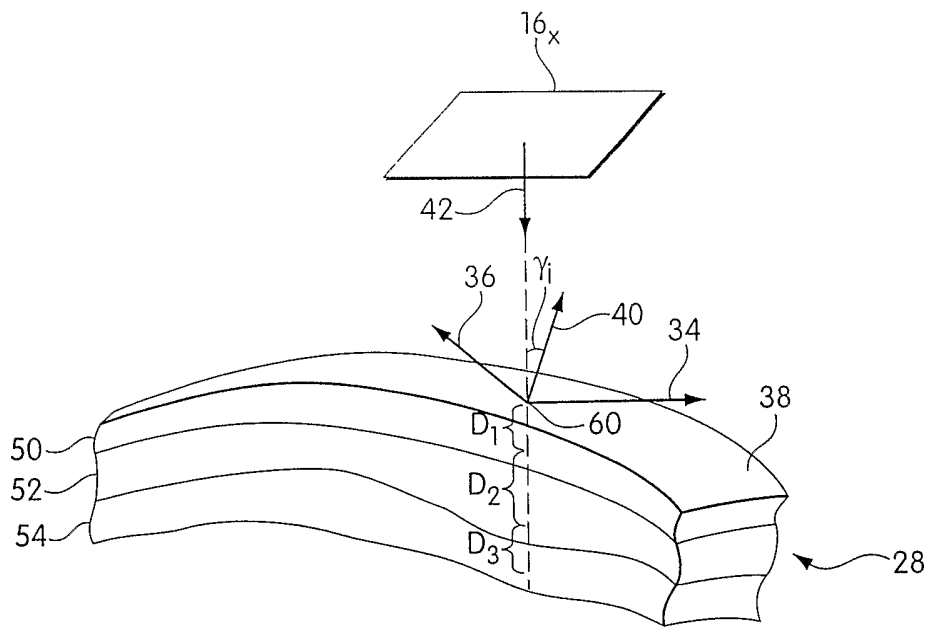

Fig. 2

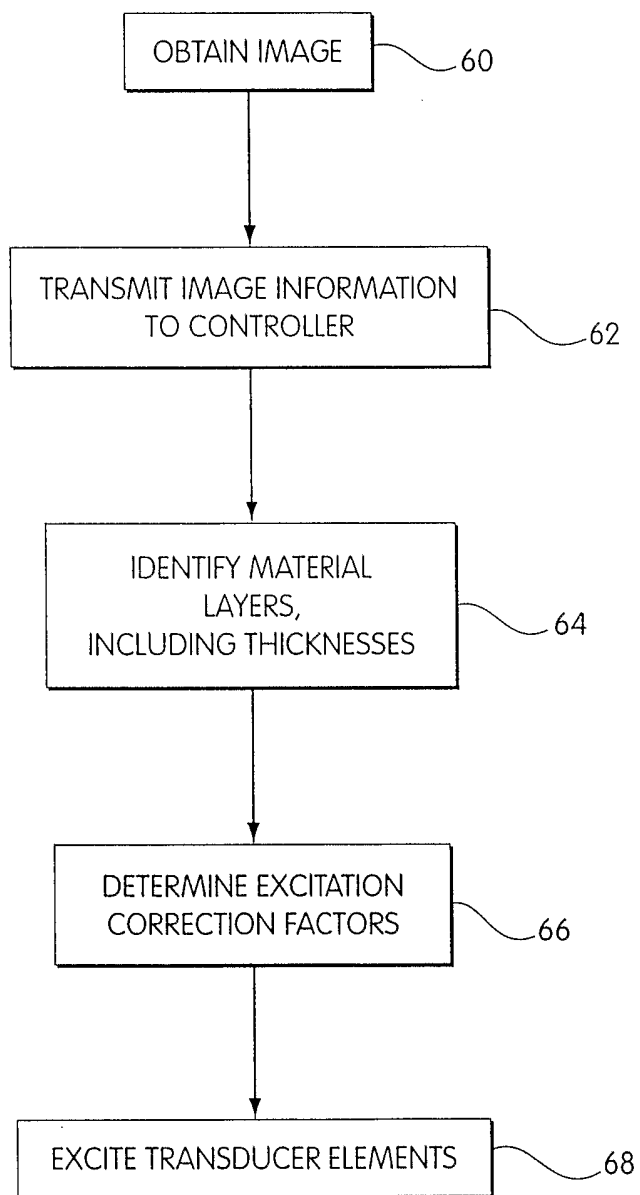

Fig. 3

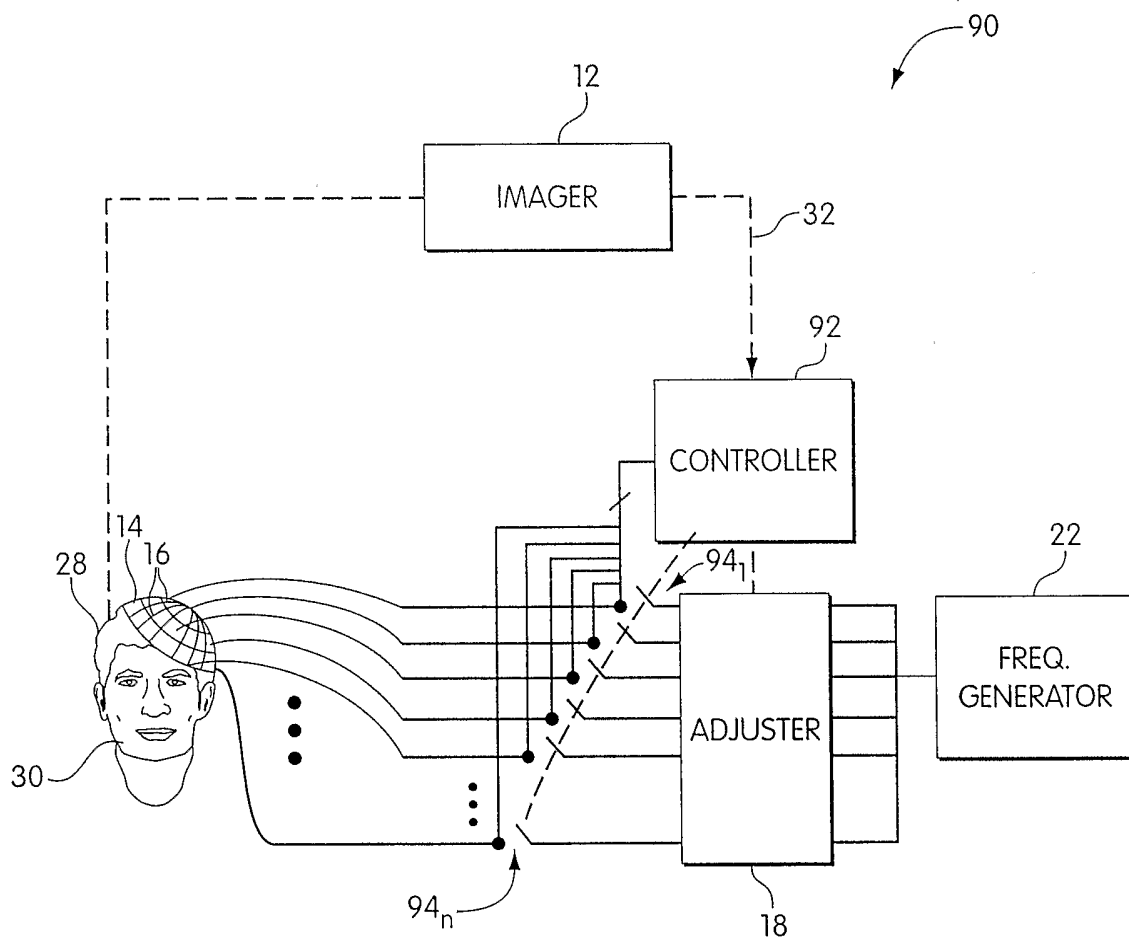

Fig. 4

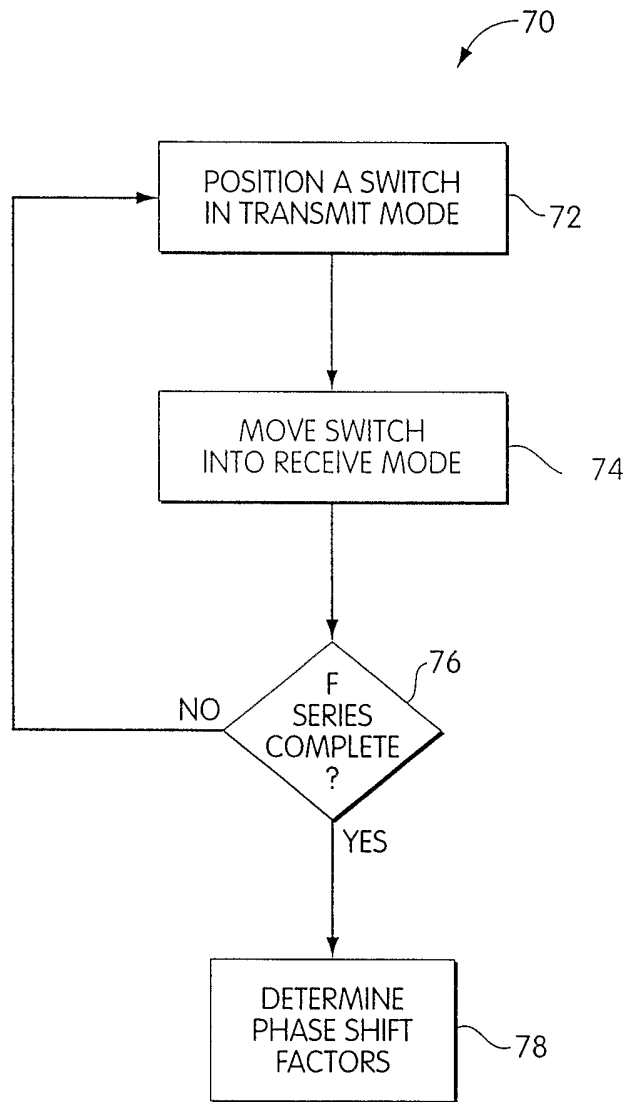

Fig. 5

FIG. 6

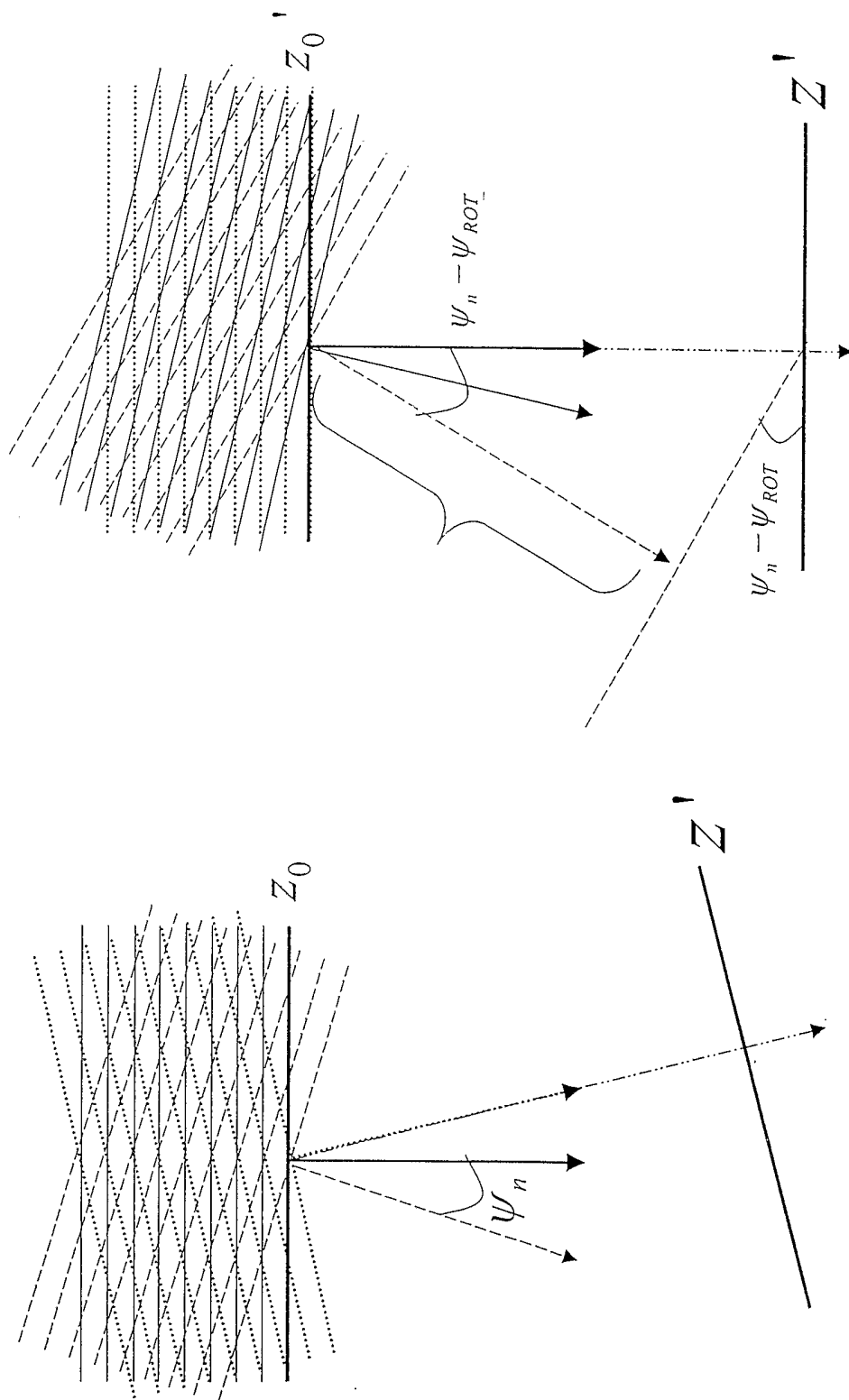
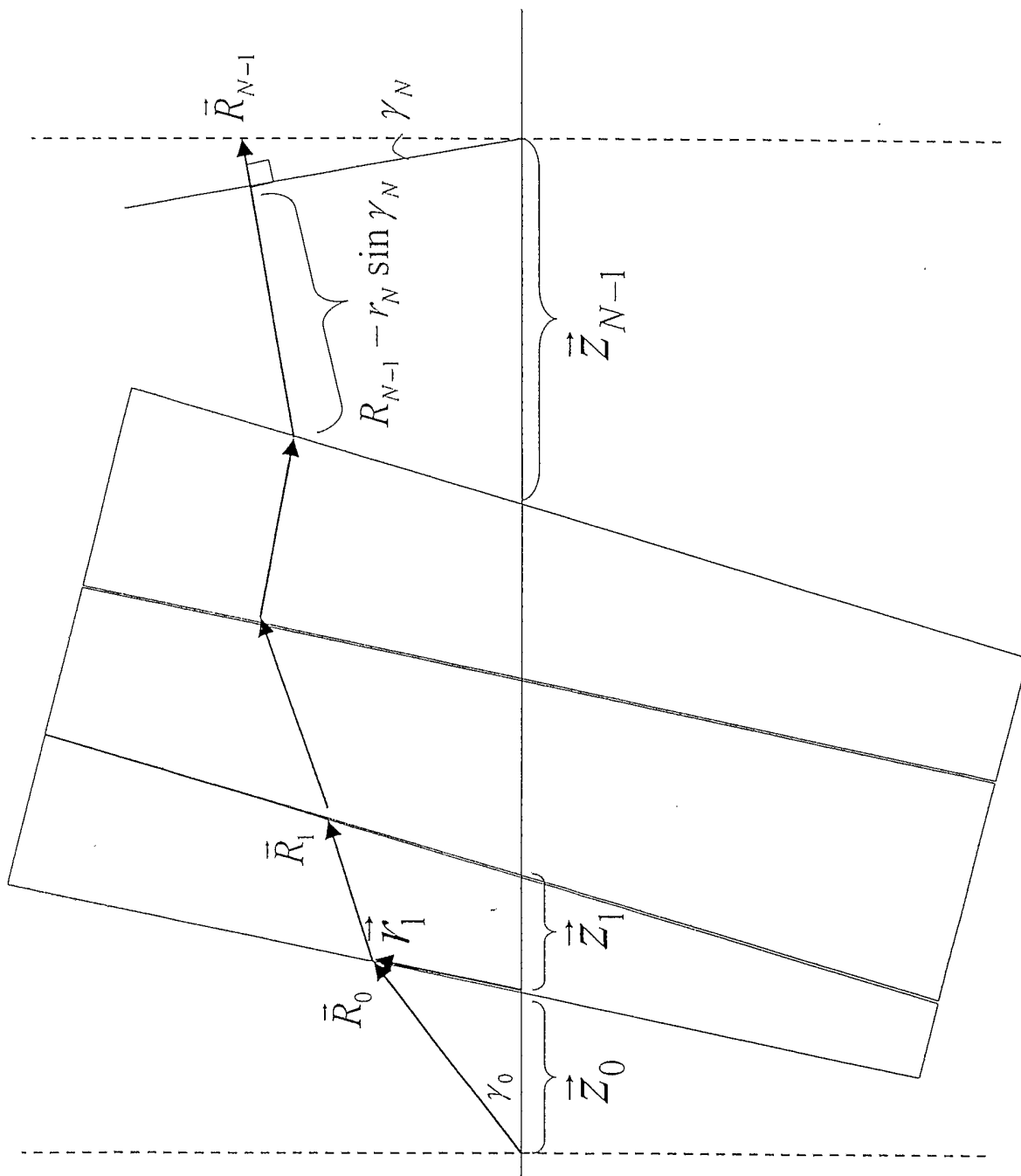

FIG. 7



INTERNATIONAL SEARCH REPORT

International application No.

PCT/US02/27130

A. CLASSIFICATION OF SUBJECT MATTER

IPC(7) :A61B 08/00

US CL :600/447

According to International Patent Classification (IPC) or to both national classification and IPC

B. FIELDS SEARCHED

Minimum documentation searched (classification system followed by classification symbols)

U.S. : 600/447, 448, 455

Documentation searched other than minimum documentation to the extent that such documents are included in the fields searched

Electronic data base consulted during the international search (name of data base and, where practicable, search terms used)

C. DOCUMENTS CONSIDERED TO BE RELEVANT

Category*	Citation of document, with indication, where appropriate, of the relevant passages	Relevant to claim No.
X	US 6,193,663 B1 (Napolitano et al.) 27 February 2001. See entire document.	1-21
X	US 6,419,633 B1 (Robinson et al.) 16 July 2002. See entire document.	1-9

 Further documents are listed in the continuation of Box C. See patent family annex.

* Special categories of cited documents:	"T" later document published after the international filing date or priority date and not in conflict with the application but cited to understand the principle or theory underlying the invention
"A" document defining the general state of the art which is not considered to be of particular relevance	"X" document of particular relevance; the claimed invention cannot be considered novel or cannot be considered to involve an inventive step when the document is taken alone
"E" earlier document published on or after the international filing date	"Y" document of particular relevance; the claimed invention cannot be considered to involve an inventive step when the document is combined with one or more other such documents, such combination being obvious to a person skilled in the art
"L" document which may throw doubts on priority claim(s) or which is cited to establish the publication date of another citation or other special reason (as specified)	"&" document member of the same patent family
"O" document referring to an oral disclosure, use, exhibition or other means	
"P" document published prior to the international filing date but later than the priority date claimed	

Date of the actual completion of the international search

24 DECEMBER 2002

Date of mailing of the international search report

11 FEB 2003

Name and mailing address of the ISA/US
Commissioner of Patents and Trademarks
Box PCT
Washington, D.C. 20231

Facsimile No. (703) 305-3230

Authorized officer

MAULIN PATEL

Telephone No. (703) -305-6933