



US00D526710S

(12) **United States Design Patent** (10) **Patent No.:** **US D526,710 S**
Sevy (45) **Date of Patent:** **** Aug. 15, 2006**

(54) **ATOMIZATION JET**

(76) Inventor: **Earl Vaughn Sevy**, 4560 N. Tomahawk Dr., Enoch, UT (US) 84720

(**) Term: **14 Years**

(21) Appl. No.: **29/179,376**

(22) Filed: **Apr. 10, 2003**

(51) **LOC (8) Cl.** **23-04**

(52) **U.S. Cl.** **D23/366**

(58) **Field of Classification Search** D23/366-369;
239/55-60, 43; 261/DIG. 65

See application file for complete search history.

(56) **References Cited**

U.S. PATENT DOCUMENTS

D306,478 S * 3/1990 von Philipp et al. D23/366

D438,297 S * 2/2001 Audebourg D23/366

D492,020 S * 6/2004 Sevy D23/366

OTHER PUBLICATIONS

The Prior Art Illustrated in Figures P1 Through P11 Represent the Atomization Jet Previously Manufactured for and Sold by Young Living Essentials Oils Corp.

The Prior Art "Atomization Jet" is no Longer Manufactured due to the Existence of the Current Art "Atomization Jet".

* cited by examiner

Primary Examiner—Lisa Lichtenstein

(57) **CLAIM**

The ornamental design for an atomization jet, as shown and described.

DESCRIPTION

Provisional patent application No. 60/464,644 "Atomization Jet" filed Apr. 10, 2004, now abandoned. Design Patent

No. D492,020 "Oval shaped diffuser well" Issued Jun. 22, 2004. Design Patent application No. 29/198,762 filed Feb. 2, 2004, now patent No. D509893. Issue fee has been paid. Patent not yet received.

FIG. 1 is a Front elevation view.

FIG. 2 is a bottom plan view.

FIG. 3 is a right side elevation view, the left side being a mirror image of that shown.

FIG. 4 is a top plan view of the jet cap portion of the atomization jet, shown separately for clarity of illustration. FIG. 5 is a front elevation view of FIG. 4.

FIG. 6 is a sectional view taken along line 6—6 in FIG. 7. FIG. 7 is a bottom view of FIG. 4

FIG. 8 is a top plan view of the atomization jet shown separately for clarity of illustration.

FIG. 9 is a front elevation view of FIG. 8

FIG. 10 is a right side elevation view of FIG. 8 the left side being a mirror image of that shown.

FIG. 11 is a bottom view of FIG. 8

FIG. 12 is a top plan view of the atomization jet in use in a double well diffuser;

FIG. 13 is a right side view of the atomization jet in use in a double well diffuser;

FIG. 14 is a top plan view of the atomization jet in use in a round diffuser; and,

FIG. 15 is a right side view of the atomization jet in use in a round diffuser.

My "atomization jet" is characterized by 3 features: It has a round ball on top of the jet and a dome radius on top of the cap. It has a very pronounced capillary break underneath the ball radius of the jet. A Teflon rod provides a dual function: A. It holds the cap in place after assembly. B. It increases capillary action that pulls the liquid from the bottom of the well to the capillary break underneath the ball radius on the jet.

The broken line showing of environmental structure is for illustrative purposes only and forms no part of the claimed design.

1 Claim, 5 Drawing Sheets

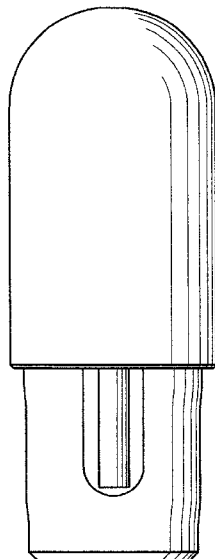

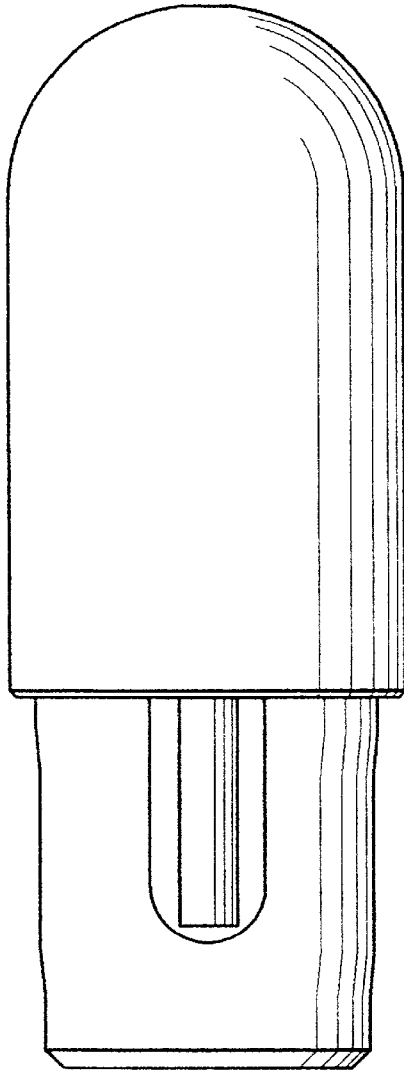

Fig. 1

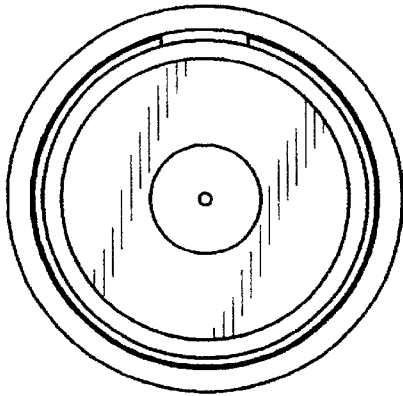

Fig. 2

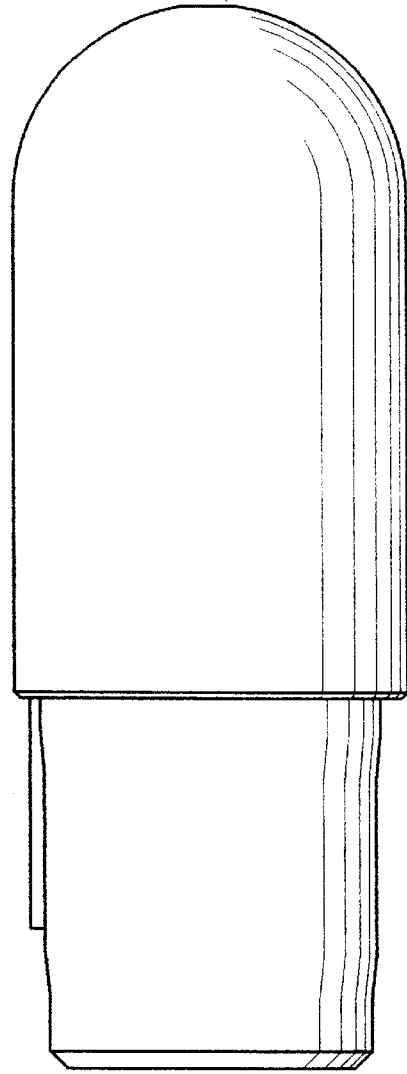

Fig. 3

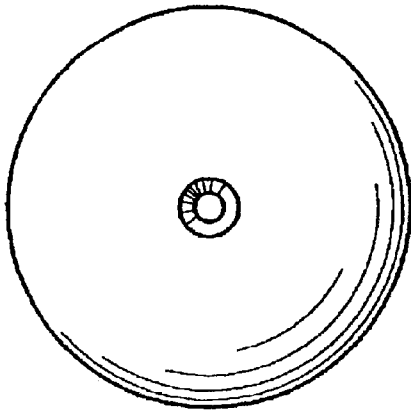

Fig. 4

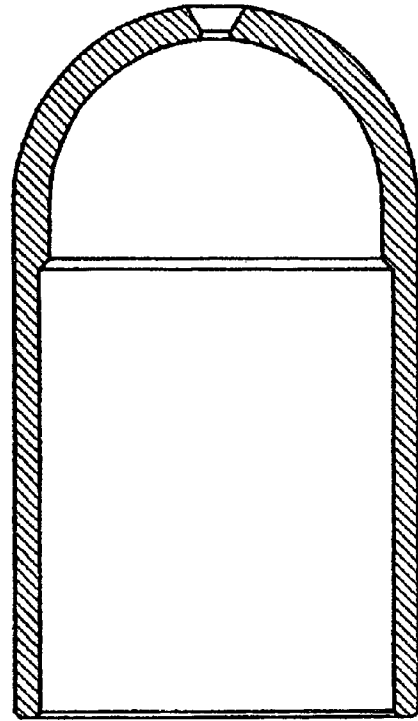

Fig. 6

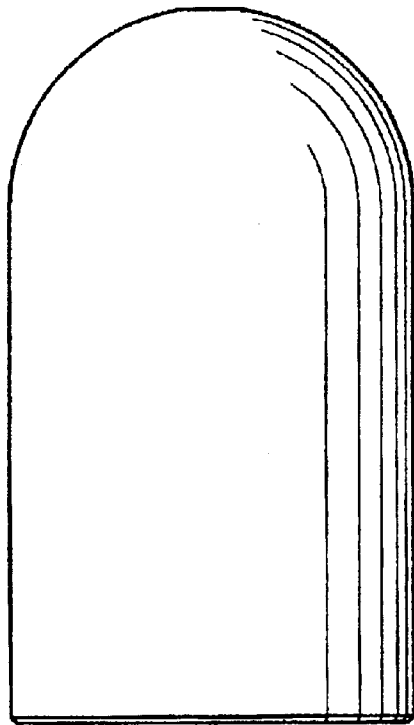

Fig. 5

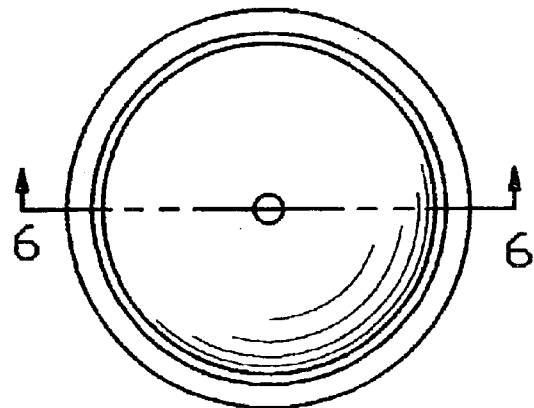

Fig. 7

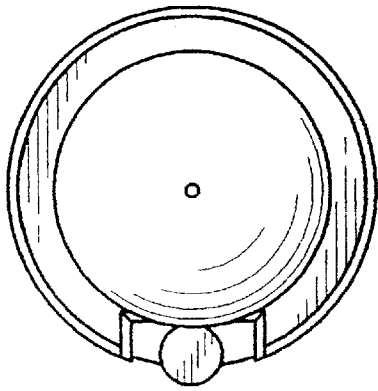

Fig. 8

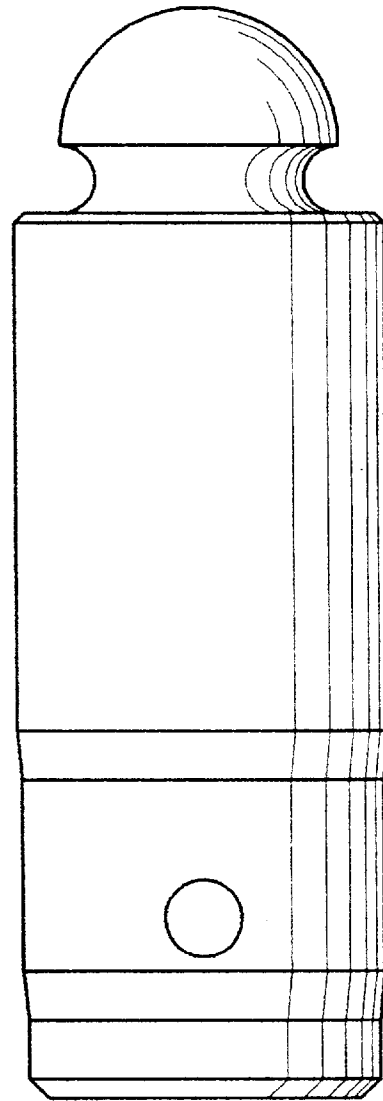

Fig. 10

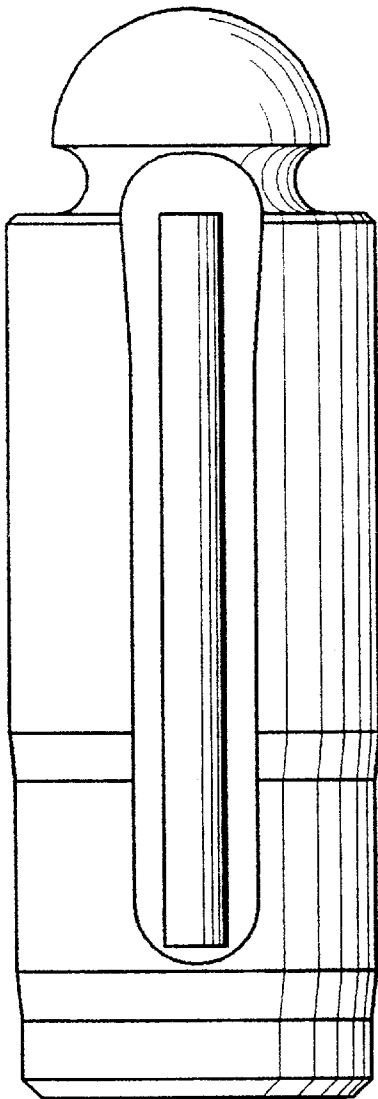

Fig. 9

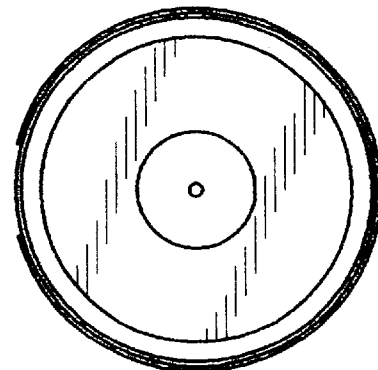

Fig. 11

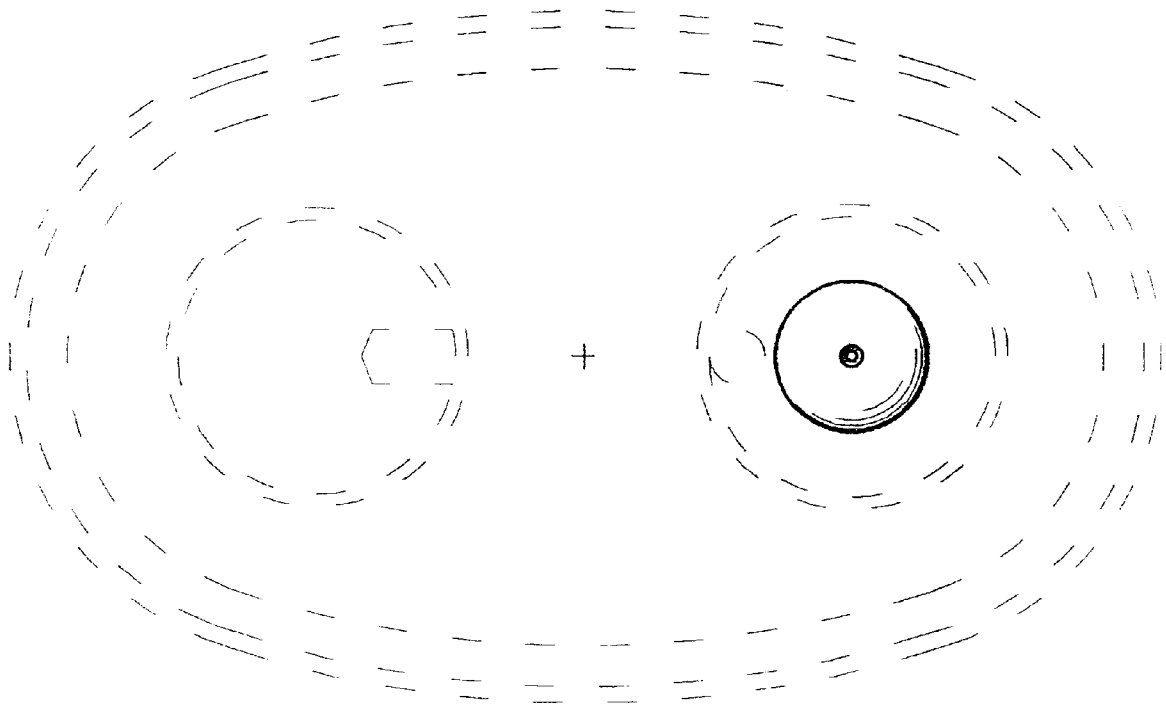

Fig. 12

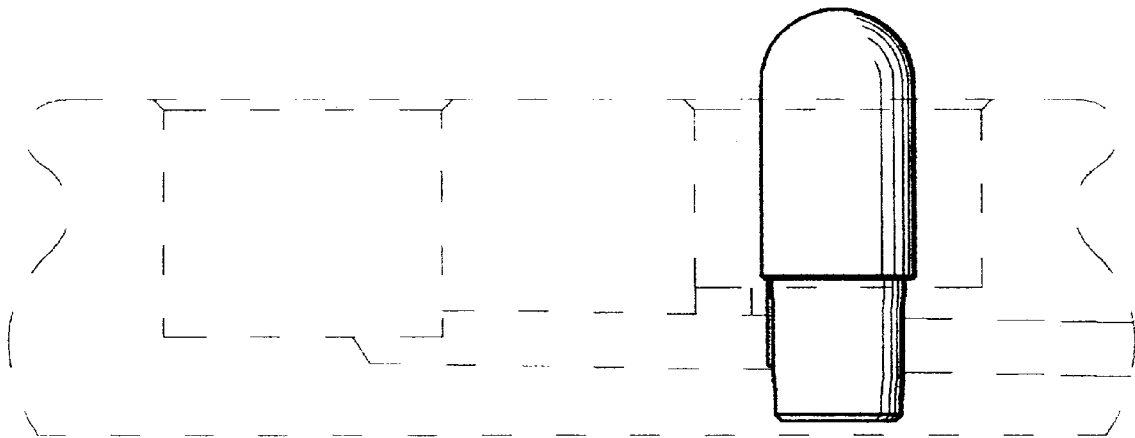

Fig. 13

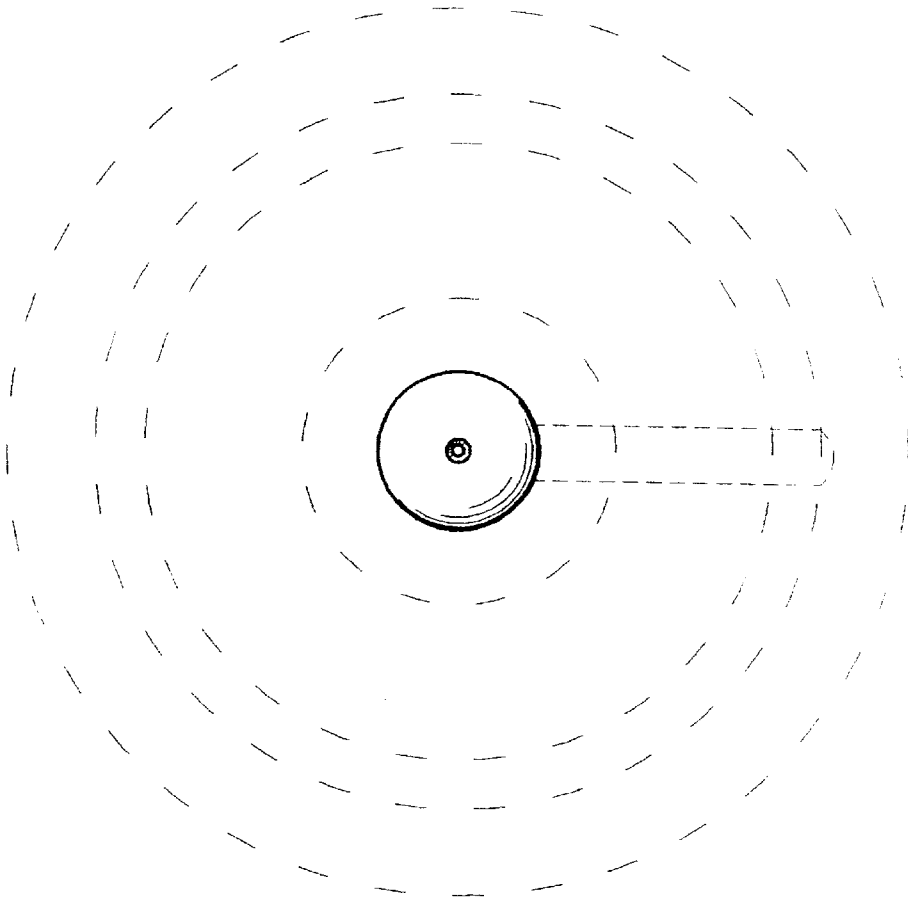

Fig. 14

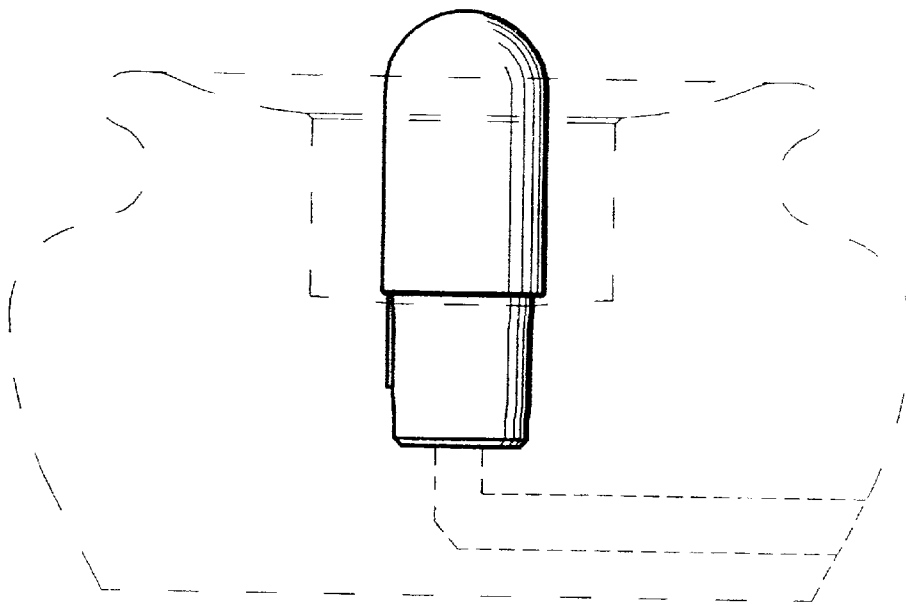

Fig. 15