



US00D769208S

(12) **United States Design Patent** (10) **Patent No.:** **US D769,208 S**
Ho et al. (45) **Date of Patent:** **** Oct. 18, 2016**

(54) **PORTABLE ELECTRONIC DEVICE**
(71) Applicant: **HTC Corporation**, Taoyuan, Taoyuan County (TW)
(72) Inventors: **Yi-Bin Ho**, Taoyuan (TW); **Yi-Shen Wang**, Taoyuan (TW); **Chen-Pang Chuang**, Taoyuan (TW); **Chih-Wei Tai**, Taoyuan (TW)
(73) Assignee: **HTC CORPORATION**, Taoyuan (TW)

Primary Examiner — Bridget L Eland
(74) *Attorney, Agent, or Firm* — Birch, Stewart, Kolasch & Birch, LLP

(**) Term: **14 Years**
(21) Appl. No.: **29/492,091**
(22) Filed: **May 28, 2014**
Related U.S. Application Data

(57) **CLAIM**
The ornamental design for portable electronic device, as shown and described.

(63) Continuation-in-part of application No. 29/488,661, filed on Apr. 22, 2014.
(51) **LOC (10) Cl.** **14-03**
(52) **U.S. Cl.**
USPC **D14/138 G**
(58) **Field of Classification Search**
USPC .. D14/138 G, 138 AD, 248, 138 R, 138 AC, D14/247, 137, 341–347
CPC H04M 1/0202; H04M 1/0235; H04M 1/0237; H04M 1/0239; H04M 1/0266; H04M 1/0268; H04M 1/027; H04M 1/0295
See application file for complete search history.

DESCRIPTION

FIG. 1 is a front perspective view of a first embodiment of a portable electronic device in accordance with our new design;
FIG. 2 is a front view thereof;
FIG. 3 is a rear view thereof;
FIG. 4 is a left side view thereof;
FIG. 5 is a right side view thereof;
FIG. 6 is a top plan view thereof;
FIG. 7 is a bottom plan view thereof;
FIG. 8 is a rear perspective view thereof;
FIG. 9 is a front perspective view of a second embodiment of a portable electronic device in accordance with our new design;
FIG. 10 is a front view thereof;
FIG. 11 is a rear view thereof;
FIG. 12 is a left side view thereof;
FIG. 13 is a right side view thereof;
FIG. 14 is a top plan view thereof;
FIG. 15 is a bottom plan view thereof;
FIG. 16 is a rear perspective view thereof;
FIG. 17 is a front perspective view of a third embodiment of a portable electronic device in accordance with our new design;
FIG. 18 is a front view thereof;
FIG. 19 is a rear view thereof;
FIG. 20 is a left side view thereof;
FIG. 21 is a right side view thereof;
FIG. 22 is a top plan view thereof;
FIG. 23 is a bottom plan view thereof; and,
FIG. 24 is a rear perspective view thereof.
The broken lines shown in the figures that are immediately adjacent to the shaded areas and define unshaded regions, represent the bounds of the claim, while all other broken lines, including the capsule shaped feature and circle at the top front near the pattern of tiny circles are directed to environment; the broken lines form no part of the claimed design.

(56) **References Cited**

U.S. PATENT DOCUMENTS

D496,645 S * 9/2004 Yoo D14/138 G
D554,099 S * 10/2007 Kim D14/138 AD

(Continued)

FOREIGN PATENT DOCUMENTS

JP D1235147 4/2005
JP D1259218 12/2005
TW D138201 S1 12/2010

OTHER PUBLICATIONS

HTC One (E8), announced Jun. 2014, [online], [retrieved on Apr. 15, 2016]. Retrieved from Internet ,<URL: <http://www.gsmarena.com>>.*

(Continued)

1 Claim, 21 Drawing Sheets

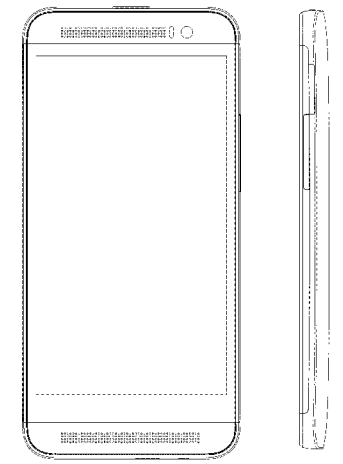

(56)

References Cited

U.S. PATENT DOCUMENTS

D556,165 S * 11/2007 Kim D14/138 G
 D583,346 S * 12/2008 Jung D14/138 AD
 D615,956 S * 5/2010 Lin D14/138 G
 D616,859 S * 6/2010 Ho D14/138 G
 D622,248 S * 8/2010 Kwon D14/138 AD
 D639,763 S * 6/2011 Kim D14/138 G
 D639,805 S * 6/2011 Song D14/138 G
 D640,662 S * 6/2011 Hwang D14/138 AD
 D645,441 S * 9/2011 Choe D14/138 G
 8,253,650 B2 * 8/2012 Sip H04M 1/0247
 345/1.1
 D692,872 S * 11/2013 Hofer D14/138 G
 D730,310 S * 5/2015 Hundt D14/138 G
 D732,498 S * 6/2015 Huang D14/138 G
 D741,279 S * 10/2015 Tai D14/138 G
 D742,351 S * 11/2015 Chen D14/138 G
 D743,923 S * 11/2015 Hubbard D14/138 G
 D743,931 S * 11/2015 Hubbard D14/203.7
 2008/0009330 A1 * 1/2008 Jung G06F 1/162
 455/575.3
 2008/0045279 A1 * 2/2008 Ohki H04M 1/0247
 455/575.1

2011/0195752 A1 * 8/2011 Siddiqui G06F 1/1622
 455/566
 2014/0286523 A1 * 9/2014 Yeh H04R 1/023
 381/394
 2014/0308869 A1 * 10/2014 Seyboth B32B 5/024
 442/291

OTHER PUBLICATIONS

HTC One (M8), announced Mar. 2014, [online], [retrieved on Apr. 15, 2016]. Retrieved from Internet ,<URL: <http://www.gsmarena.com>>.*
 LG KF700, announced Feb. 2008, [online], [retrieved on Mar. 21, 2008 & May 14, 2008]. Retrieved from Internet ,<URL: <http://www.gsmarena.com>>.*
 LG Optimus 3D P920, announced Jan. 2011, [online], [retrieved on Feb. 17, 2011]. Retrieved from Internet ,<URL: <http://www.gsmarena.com>>.*
 BlackBerry Z10, announced Jan. 2013, [online], [retrieved on Mar. 4, 2013]. Retrieved from Internet ,<URL: <http://www.gsmarena.com>>.*
 HE, [Scoop] The New HTC One Ace, <http://www.ifanr.com>/421704, May 26, 2014.

* cited by examiner

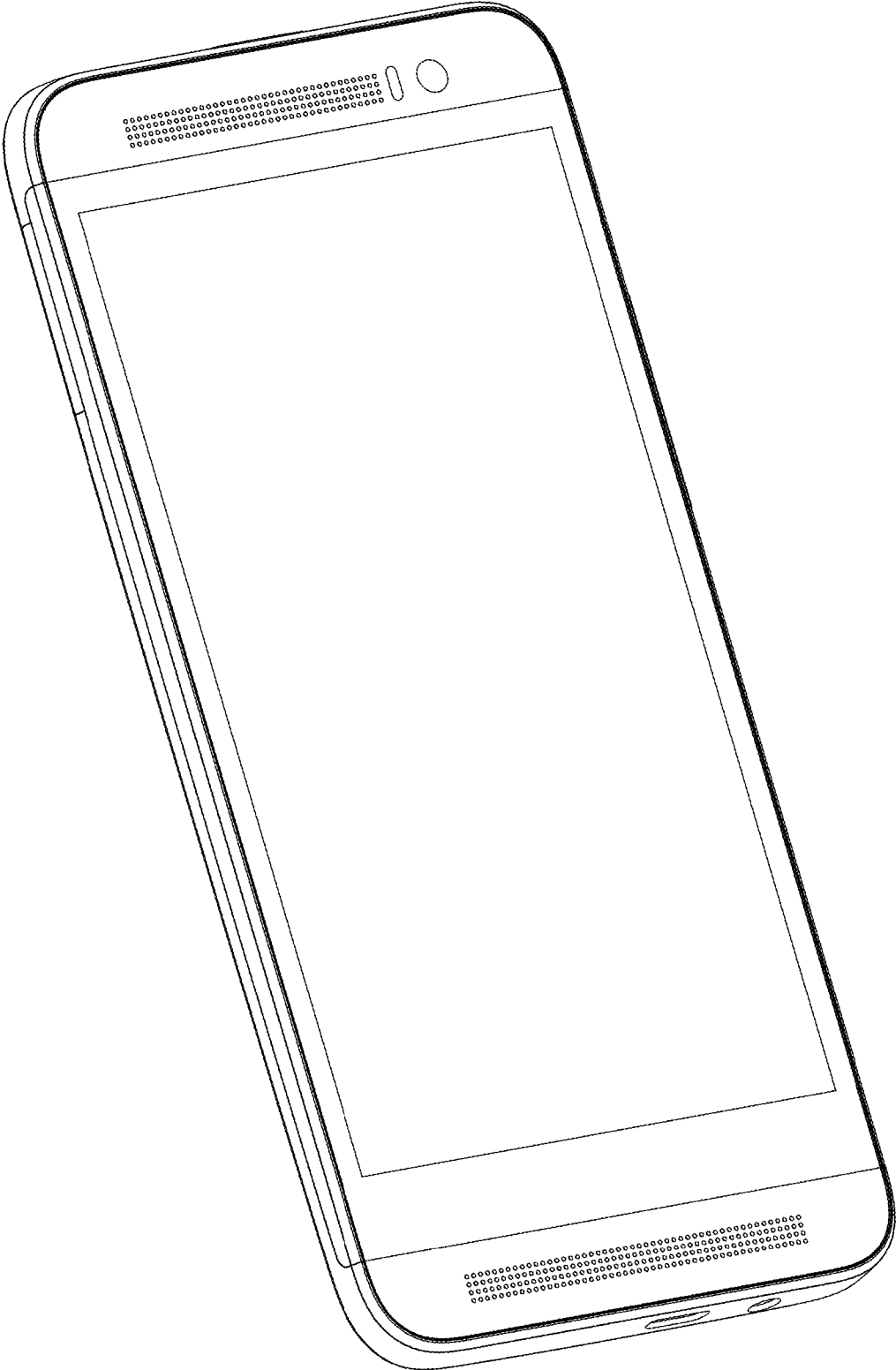

FIG. 1

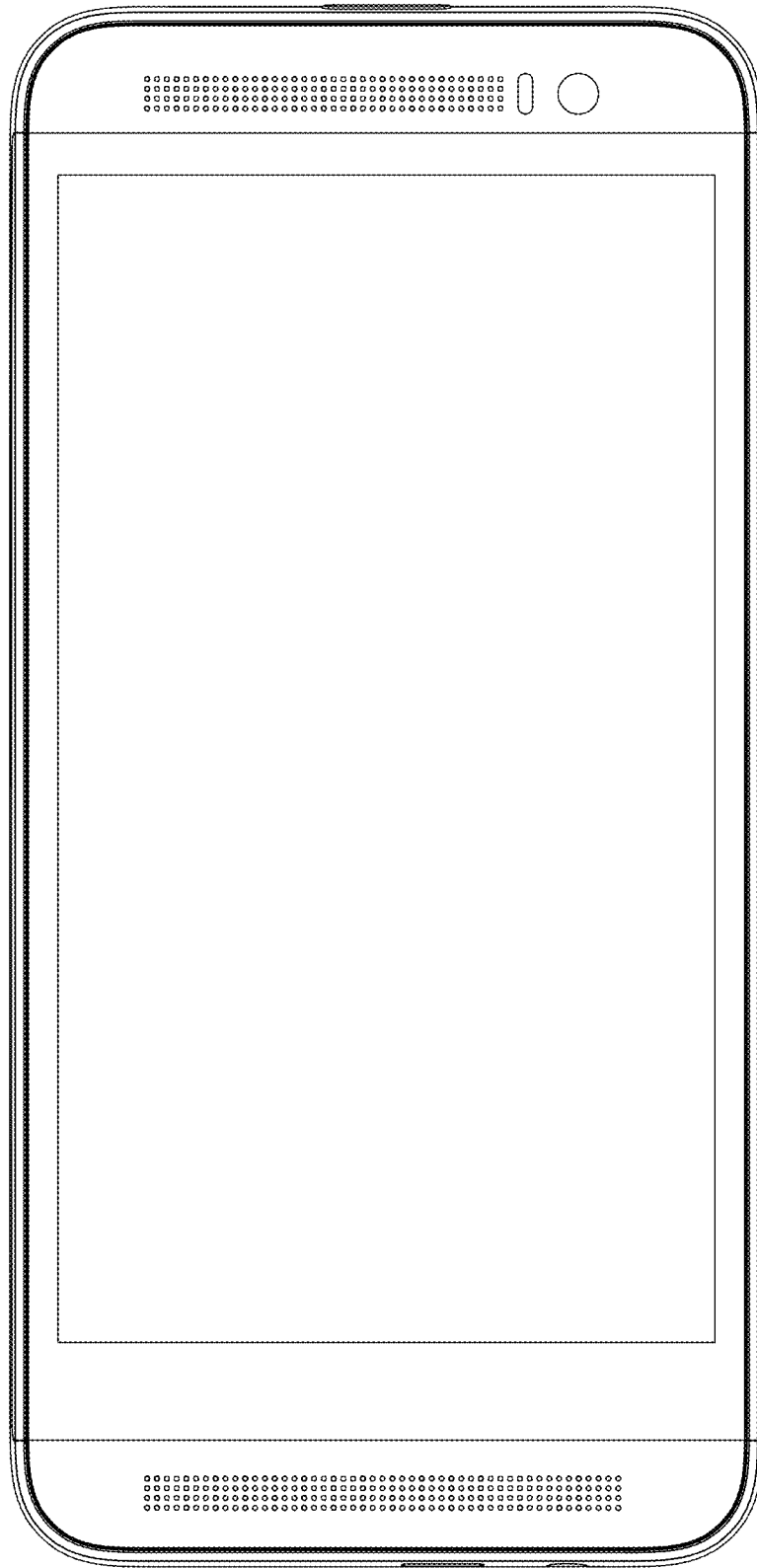

FIG. 2

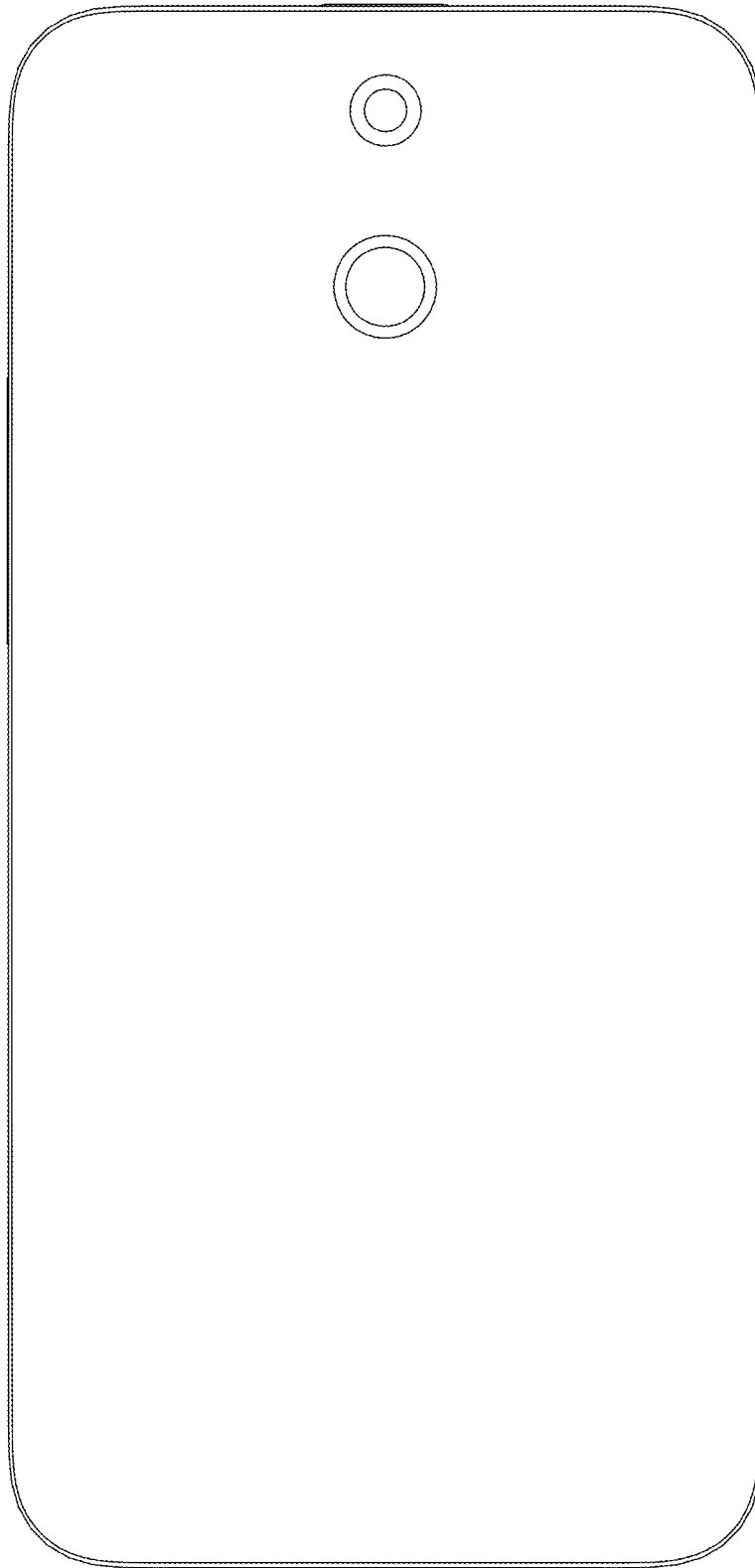

FIG. 3

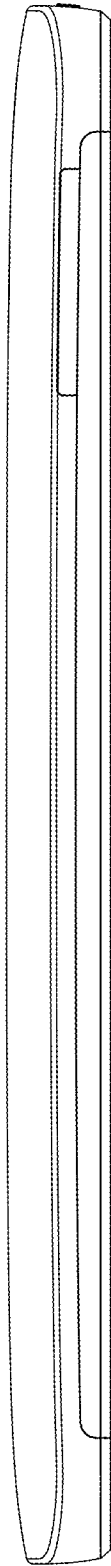

FIG. 4

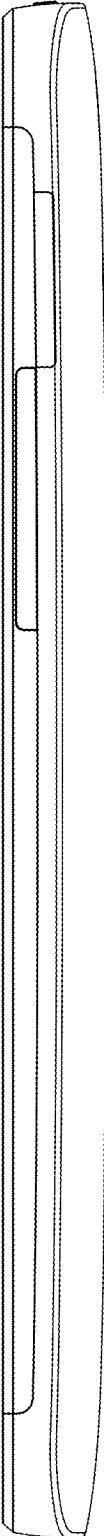

FIG. 5

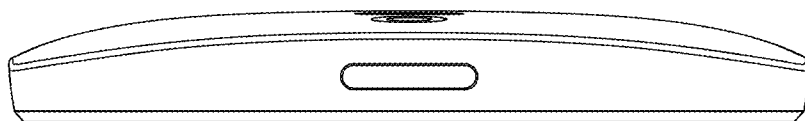

FIG. 6

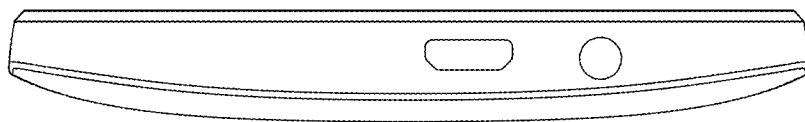

FIG. 7



FIG. 8

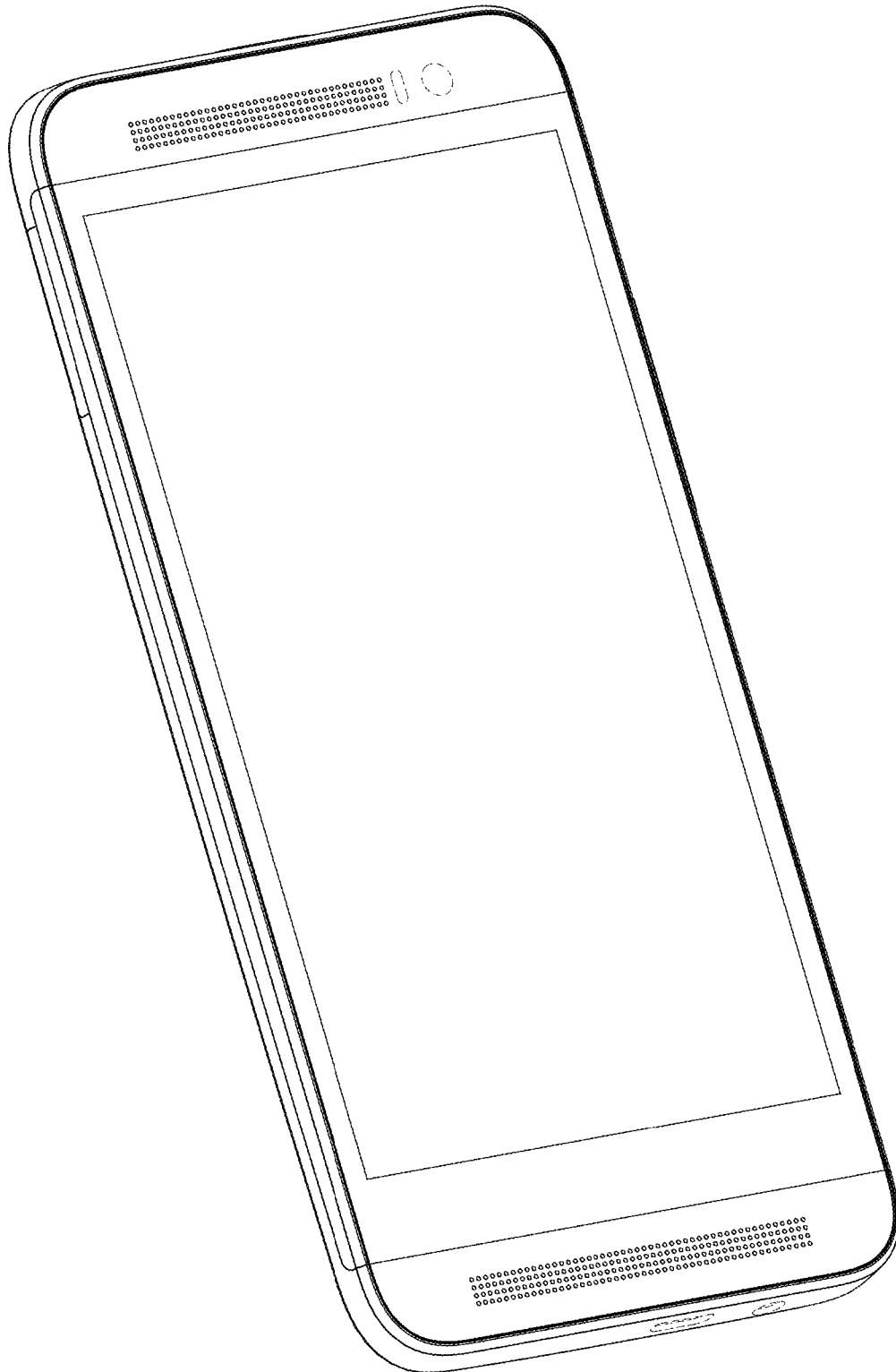

FIG. 9

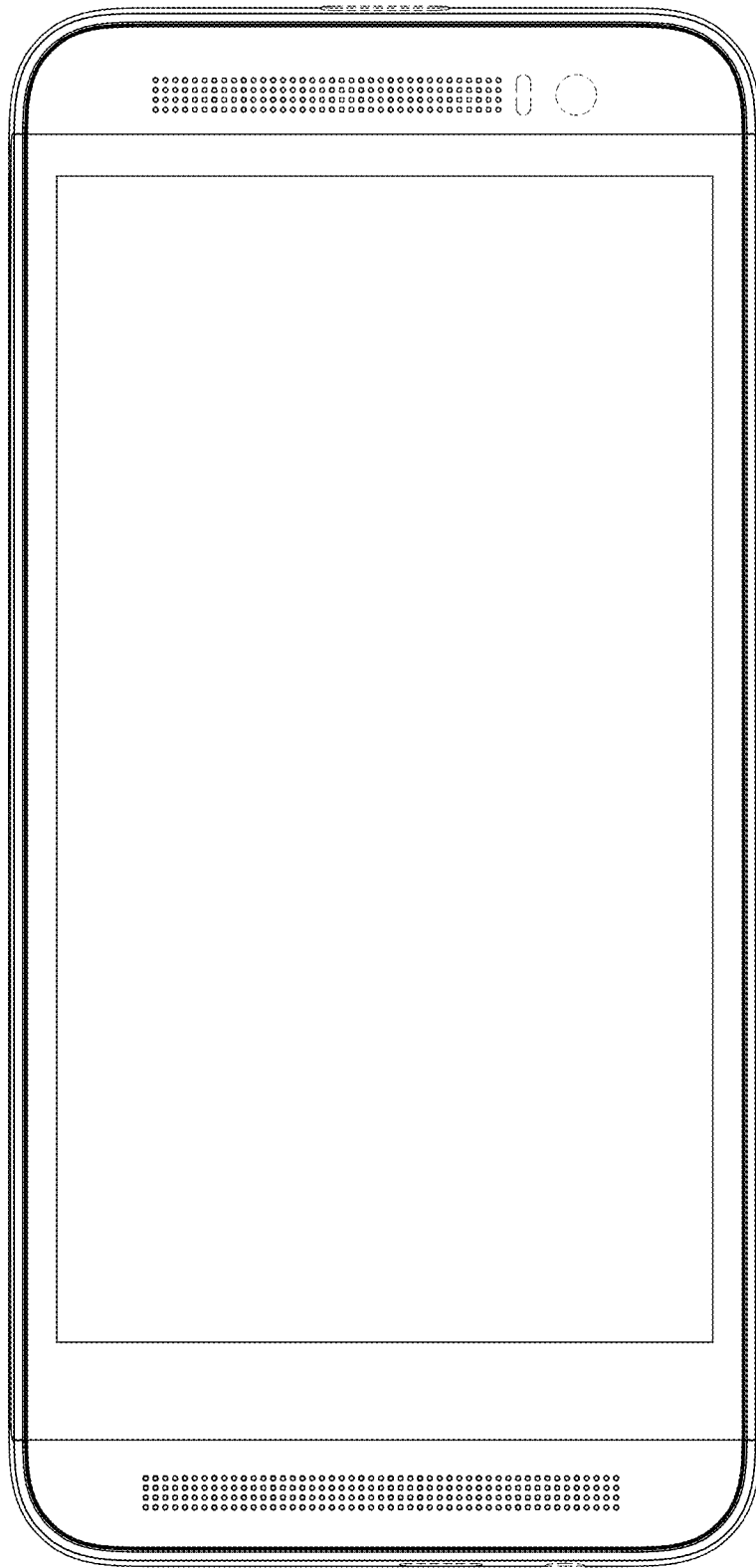

FIG. 10

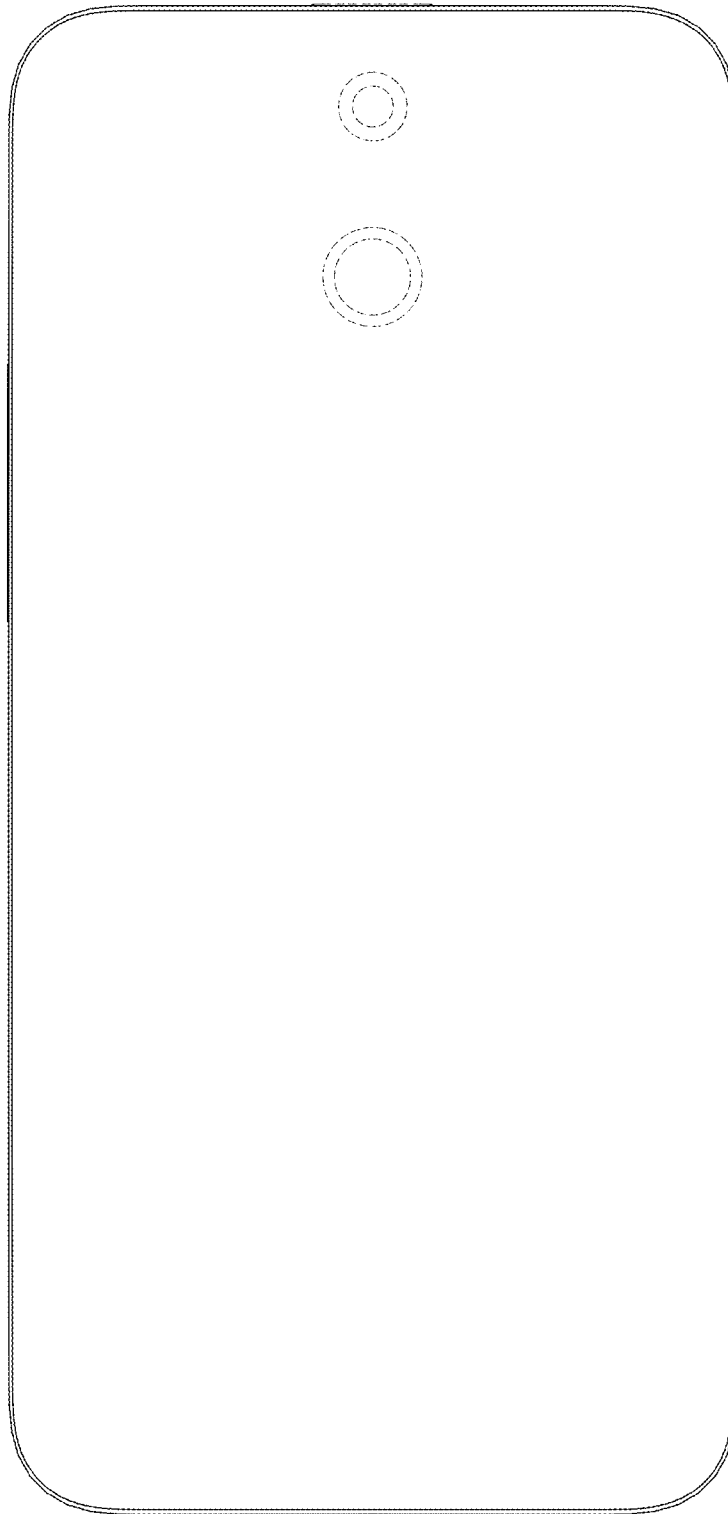

FIG. 11

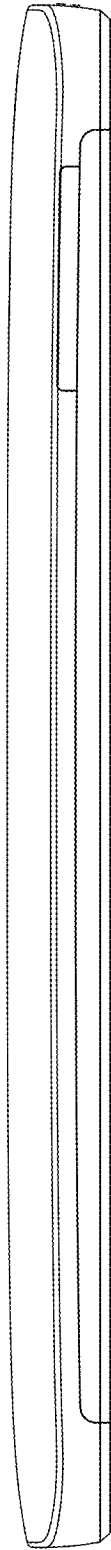

FIG. 12

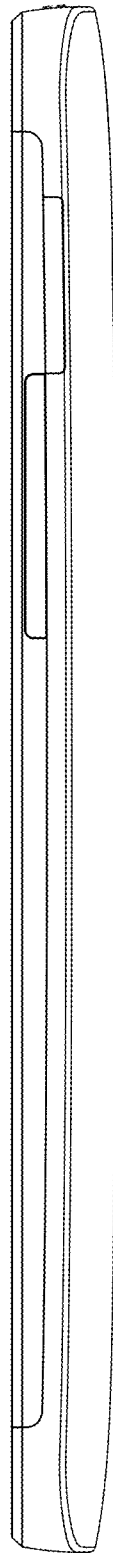

FIG. 13

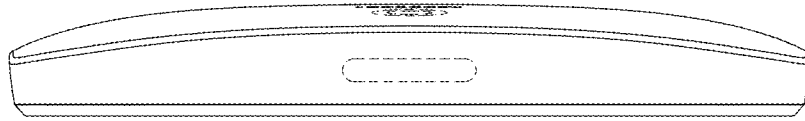

FIG. 14

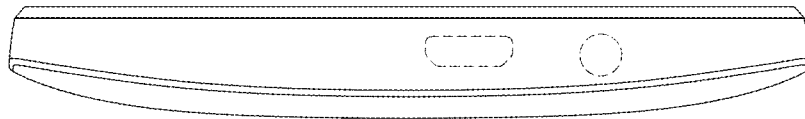

FIG. 15



FIG. 16

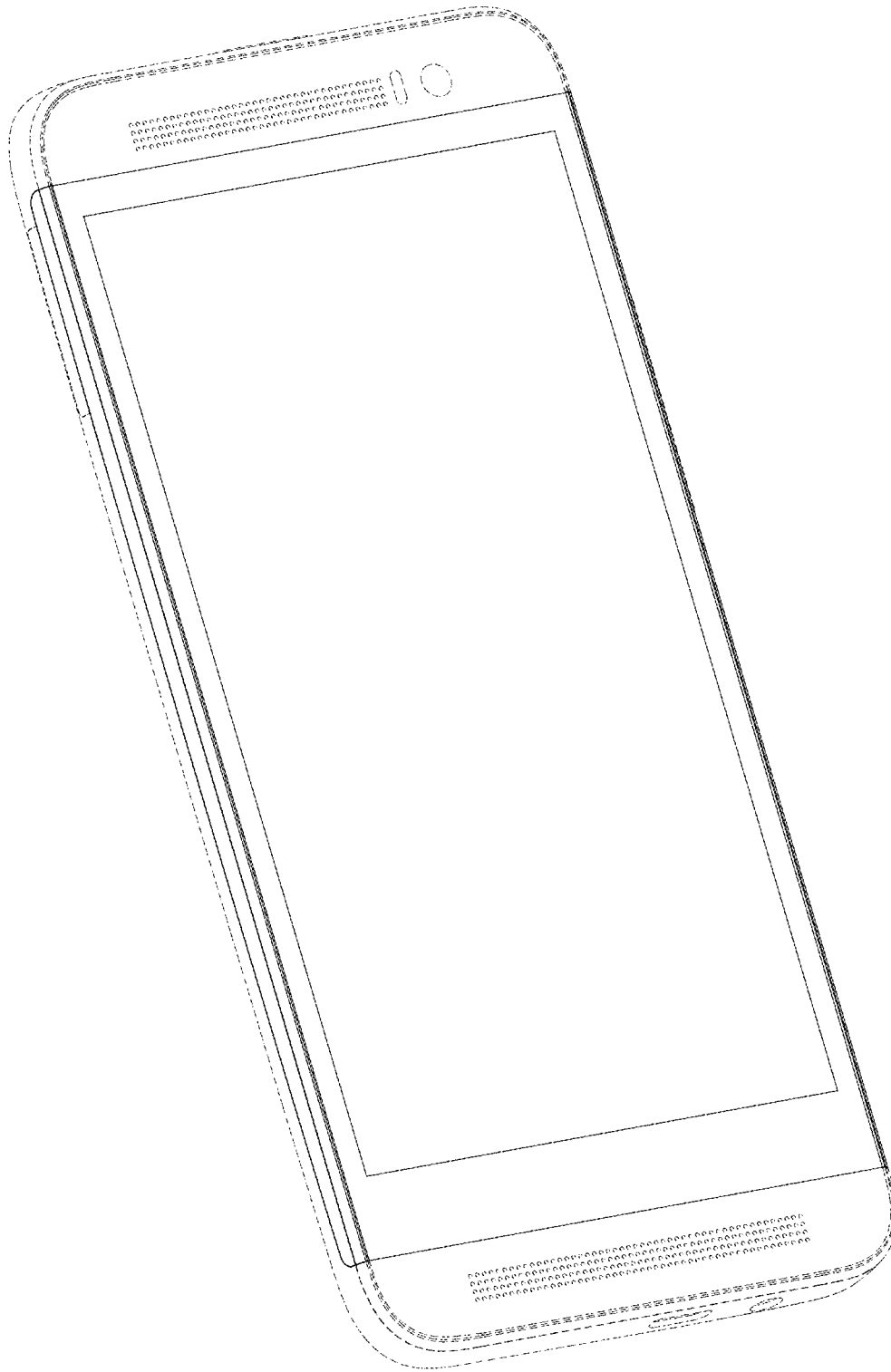

FIG. 17

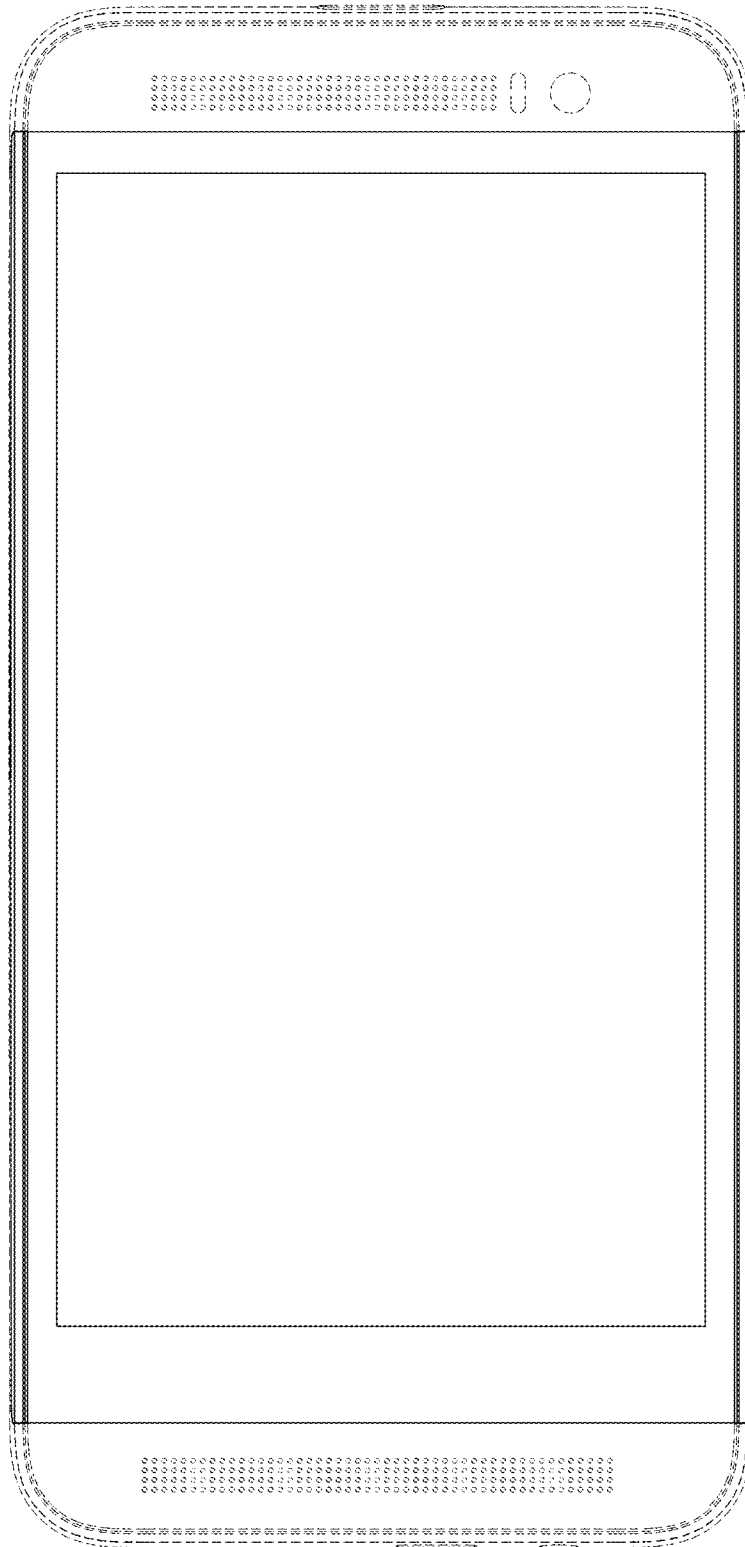

FIG. 18



FIG. 19

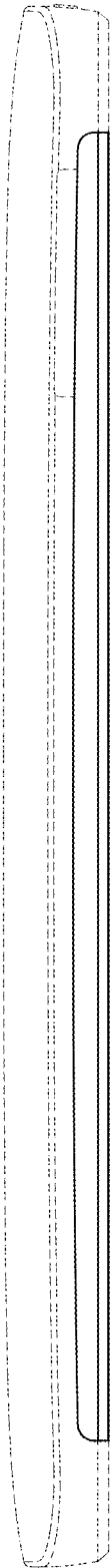

FIG. 20

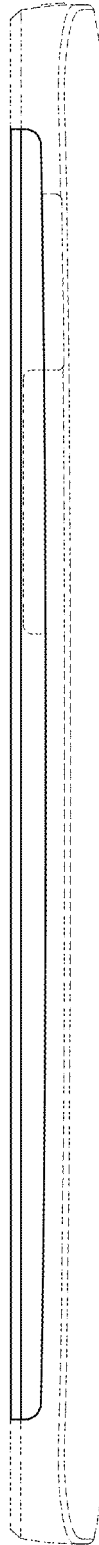

FIG. 21

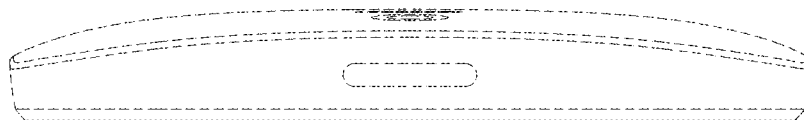

FIG. 22

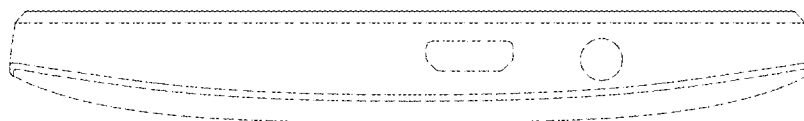

FIG. 23

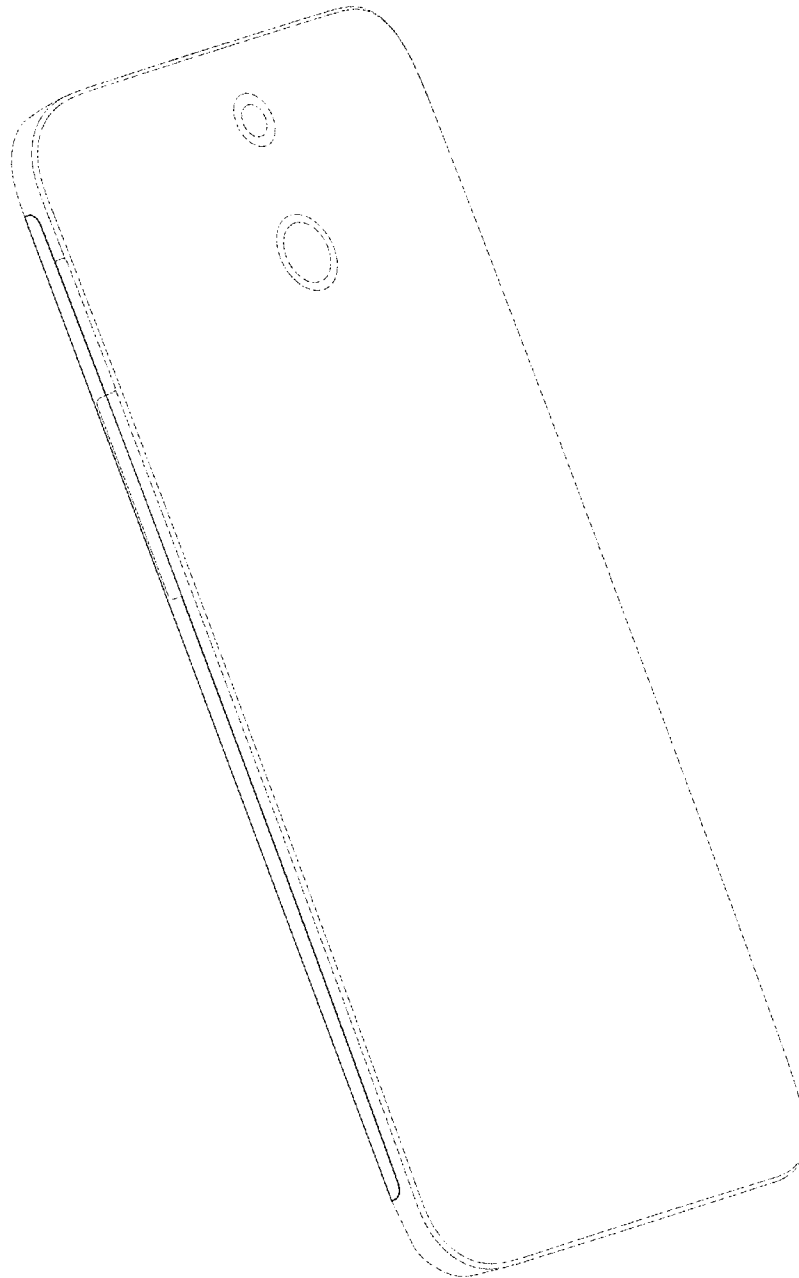

FIG. 24