



USOD1007266S

(12) **United States Design Patent**
Fu

(10) **Patent No.:** **US D1,007,266 S**

(45) **Date of Patent:** **** Dec. 12, 2023**

(54) **MULTI-FUNCTIONAL PLIER**
(71) Applicant: **Yingxiang Fu, Yangjiang (CN)**
(72) Inventor: **Yingxiang Fu, Yangjiang (CN)**
(**) Term: **15 Years**

D939,303 S * 12/2021 Peng D8/55
D941,106 S * 1/2022 Zhong D8/55
D941,107 S * 1/2022 Zhong D8/55
D941,655 S * 1/2022 Peng D8/105
D949,656 S * 4/2022 Shen D8/55
D957,223 S * 7/2022 Zhu D8/55

(Continued)

(21) Appl. No.: **29/776,102**
(22) Filed: **Mar. 28, 2021**
(51) **LOC (14) Cl.** **08-05**
(52) **U.S. Cl.**
USPC **D8/52**
(58) **Field of Classification Search**
USPC D8/4, 5, 21, 26, 51-58, 92, 93, 105;
D19/69, 72; D21/532; D22/149, 150;
D24/146, 148, 149
CPC B25B 7/16; B25B 7/02; B25B 7/14; B25B
7/22; H02G 1/1209
See application file for complete search history.

OTHER PUBLICATIONS

Leatherman, posted Apr. 24, 2020 [online], [retrieved Jun. 26, 2023]. Retrieved from internet, <https://www.amazon.com/LEATHERMAN-LT832625-HERRAMIENTAS-EXTRARESISTENTES/dp/B07K5PJ7ZT/ref> (Year: 2020).*

Primary Examiner — David G Muller
Assistant Examiner — Christina Gabrielle Cosden

(57) **CLAIM**

The ornamental design for a multi-functional plier, as shown and described.

DESCRIPTION

FIG. 1 is a front, right side, top perspective view of a multi-functional plier showing my new design; FIG. 2 is a front elevational view thereof; FIG. 3 is a rear elevational view thereof; FIG. 4 is a left side elevational view thereof; FIG. 5 is a right side elevational view thereof; FIG. 6 is a top plan view thereof; FIG. 7 is a bottom plan view thereof; and FIG. 8 is a front, right side, top perspective view of the multi-functional plier showing some of the additional tools thereof in a deployed position; and, FIG. 9 is a front, right side, top perspective view of the multi-functional plier showing the multi-functional plier in a totally collapsed state. The broken lines depict portions of the multi-functional plier that form no part of the claimed design.

1 Claim, 9 Drawing Sheets

(56) **References Cited**

U.S. PATENT DOCUMENTS

6,047,426	A	*	4/2000	McIntosh	B25F 1/04
						7/129
D445,009	S	*	7/2001	Rivera	D8/52
D474,085	S	*	5/2003	Rivera	D8/58
D477,509	S	*	7/2003	Allen	D8/55
D478,258	S	*	8/2003	Yeh	D8/55
D521,829	S	*	5/2006	Yale	D8/4
D542,107	S	*	5/2007	Yale	D8/52
D571,181	S	*	6/2008	Klecker	D8/105
D626,810	S	*	11/2010	Steineckert	B25F 1/04
						D8/55
D635,002	S	*	3/2011	Rivera	D8/105
9,095,970	B2	*	8/2015	Purnomohadi	B25F 1/04
D764,252	S	*	8/2016	Klecker	D8/105
D848,808	S	*	5/2019	Zhong	D8/55
D884,452	S	*	5/2020	Hallbrook	D8/105
D884,453	S	*	5/2020	Hallbrook	D8/105
D887,245	S	*	6/2020	Liu	D8/105
D924,657	S	*	7/2021	Li	D8/105

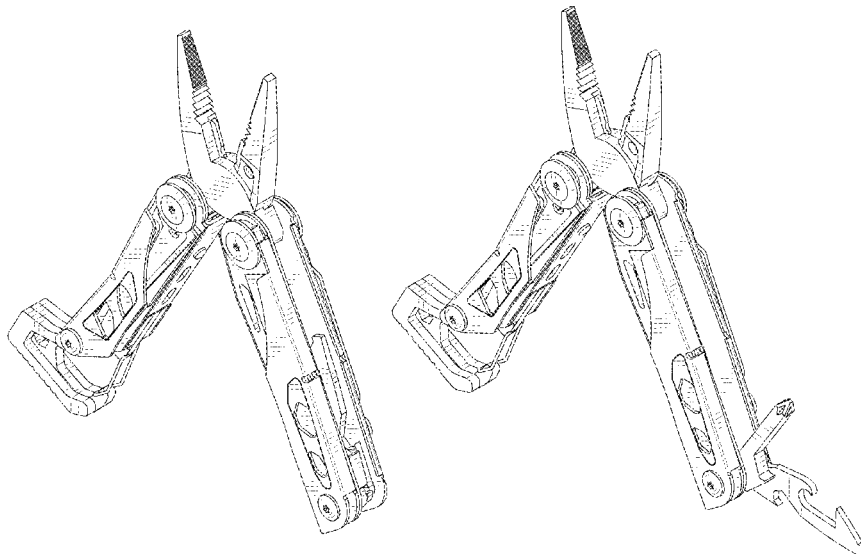

(56)

References Cited

U.S. PATENT DOCUMENTS

2006/0200913	A1*	9/2006	Guan	B25F 1/003 7/128
2010/0122420	A1*	5/2010	Nason	B25F 1/003 7/128
2011/0154577	A1*	6/2011	Eubanks	B25F 1/003 7/128
2018/0272515	A1*	9/2018	Sun	B26B 11/005
2020/0306935	A1*	10/2020	Bessac	B25F 1/003

* cited by examiner

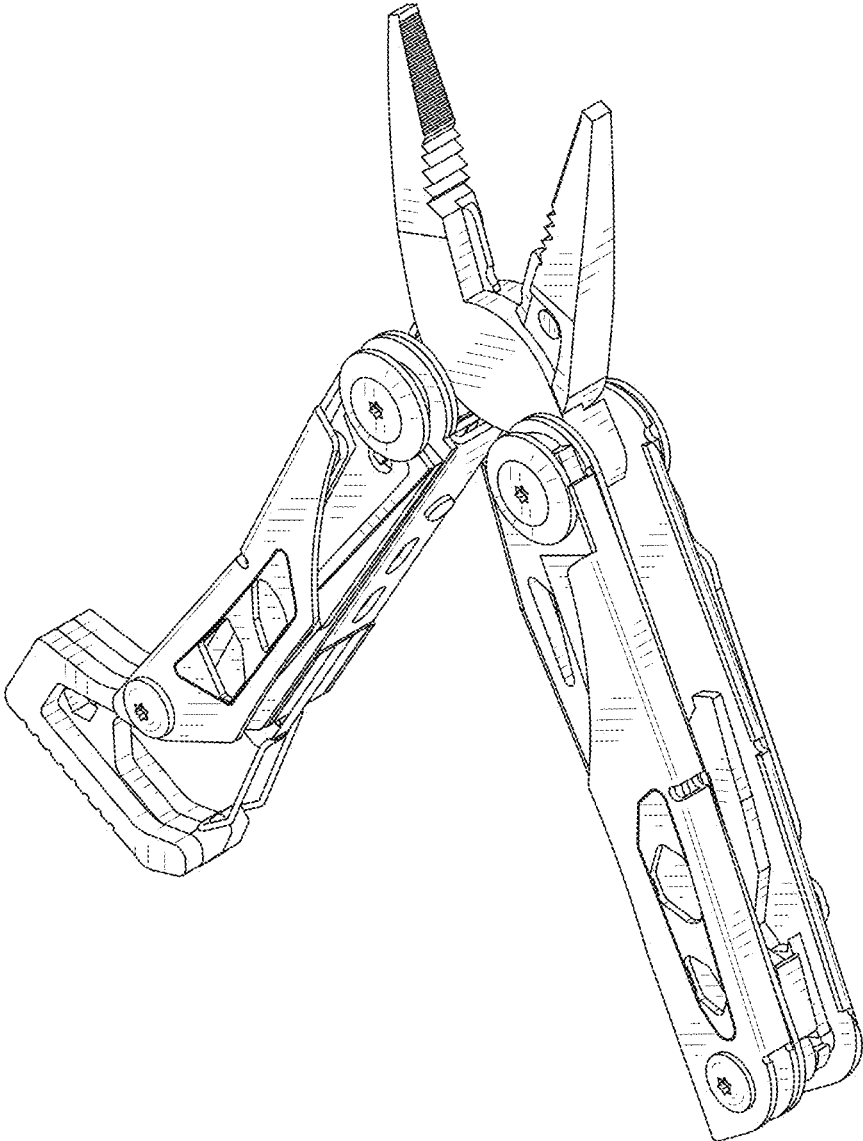

FIG.1

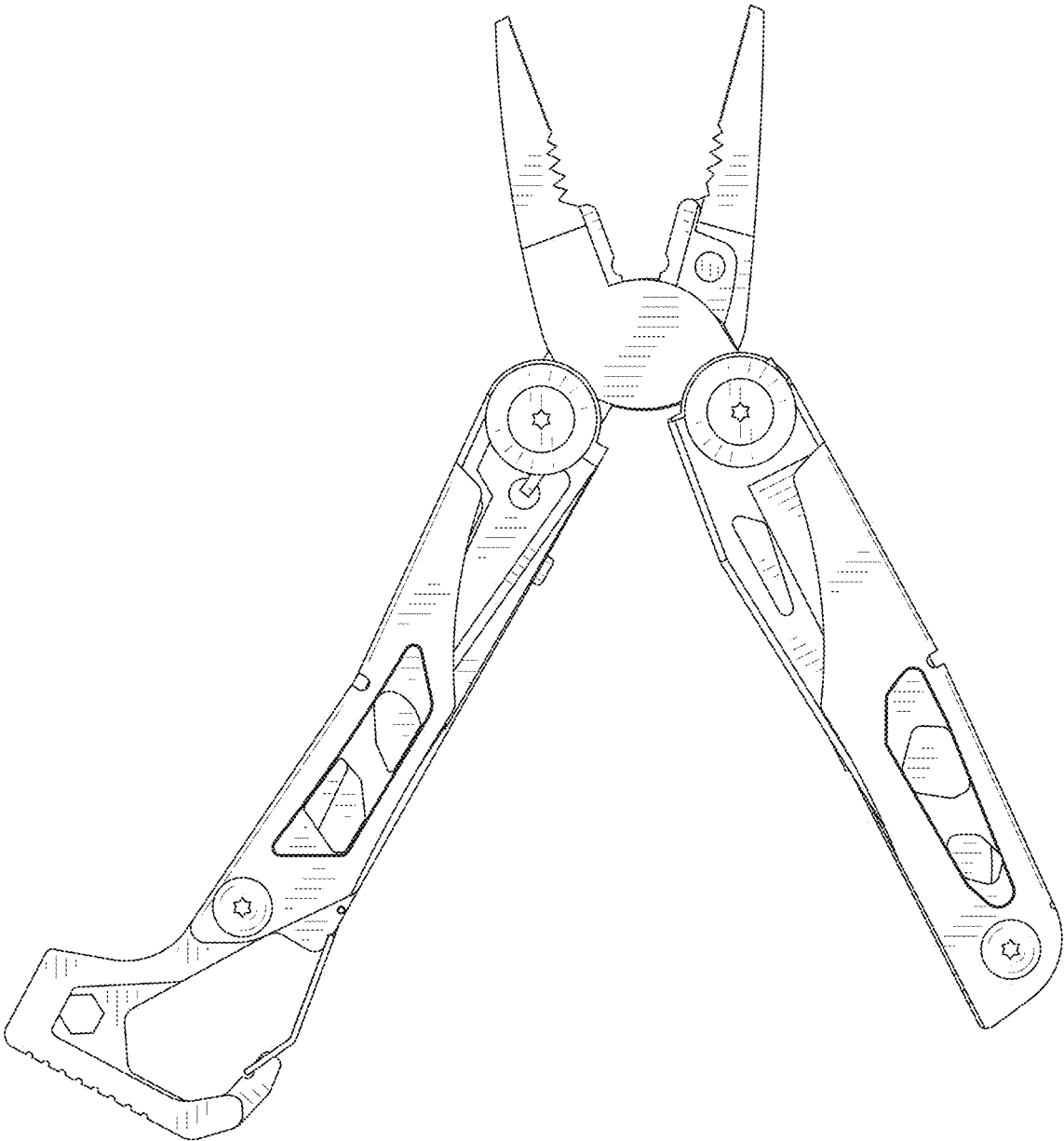

FIG.2

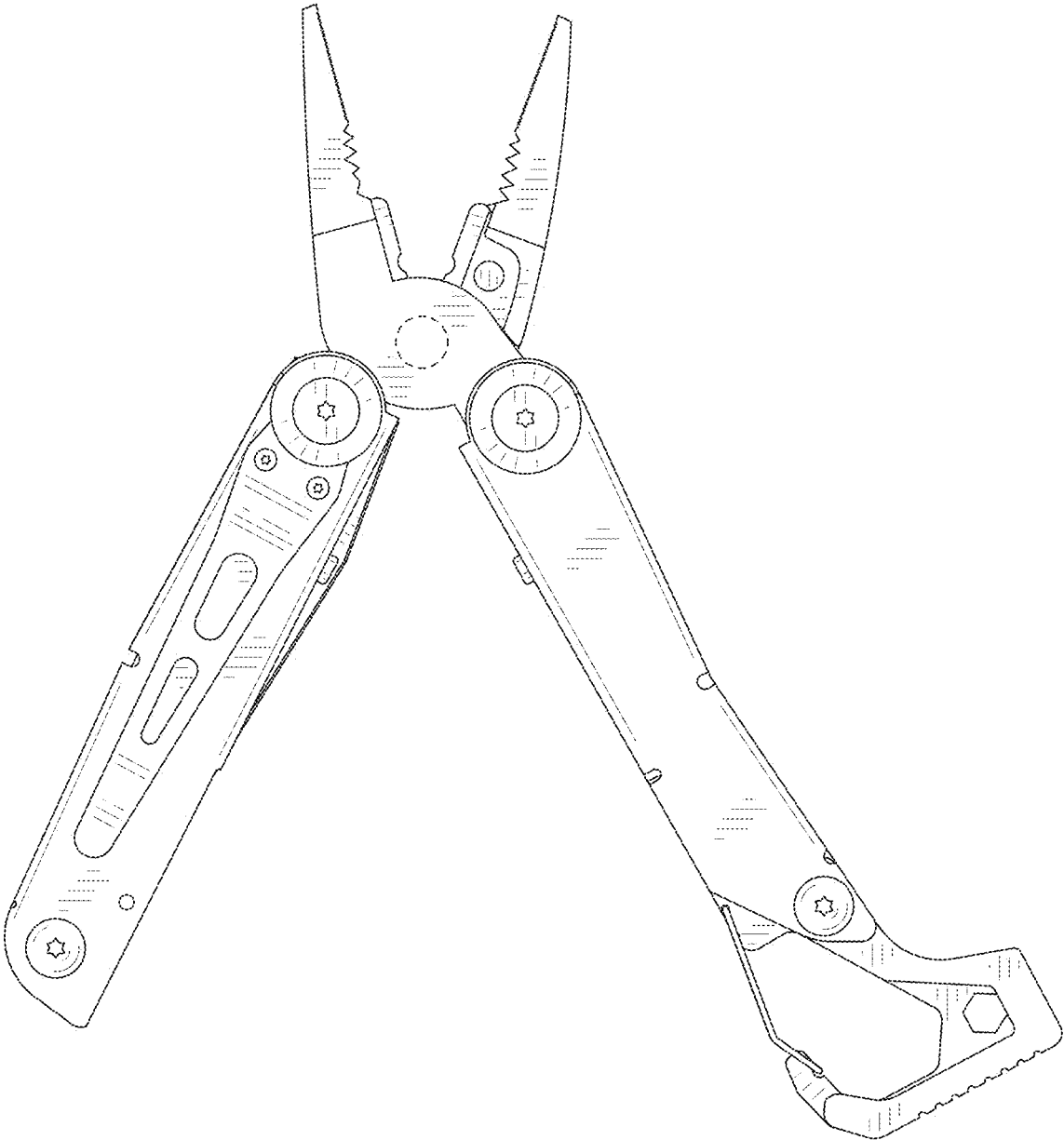

FIG.3

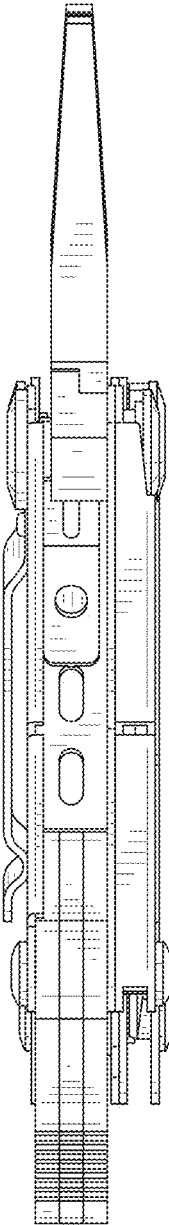

FIG.4

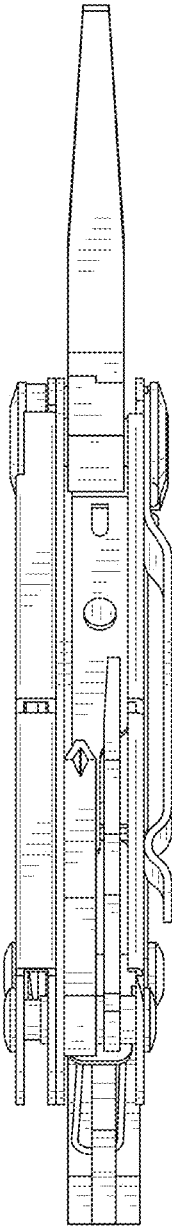

FIG.5

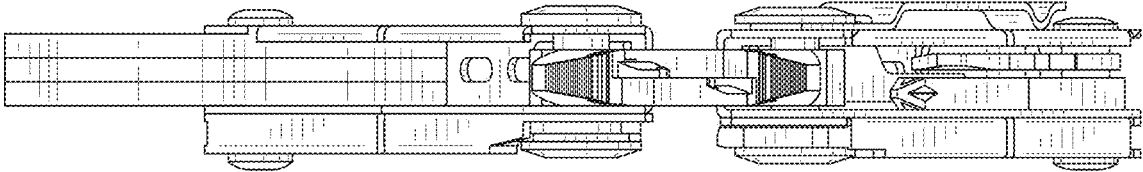

FIG.6

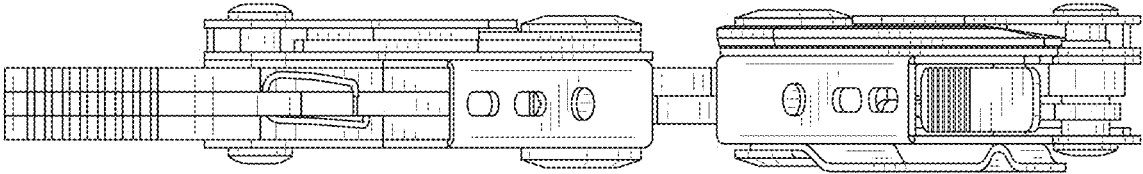

FIG.7

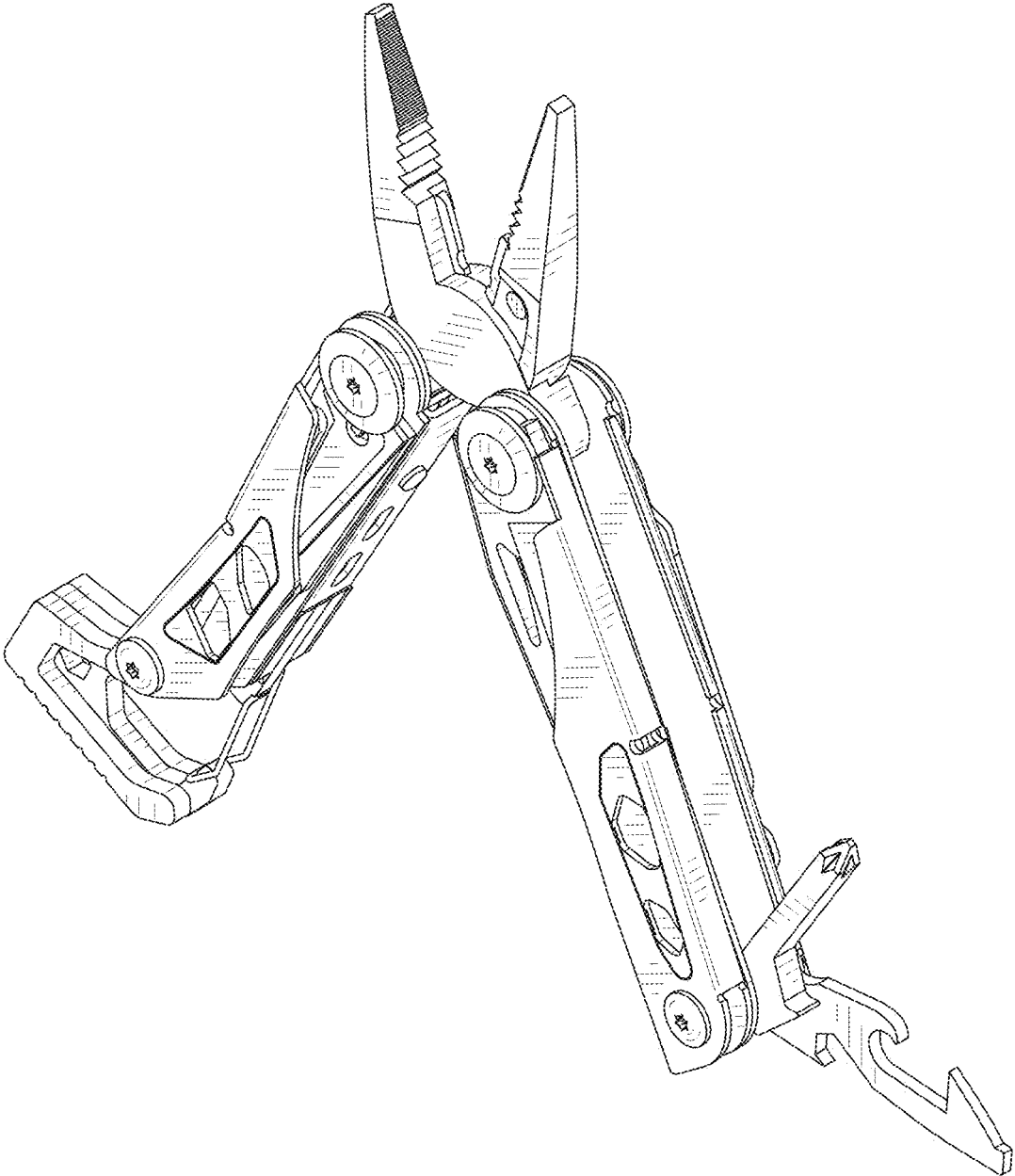

FIG.8

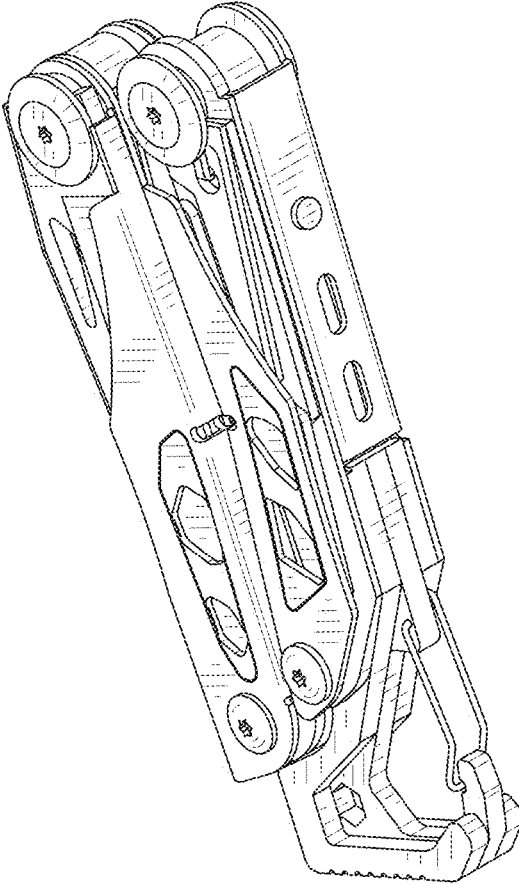

FIG.9