

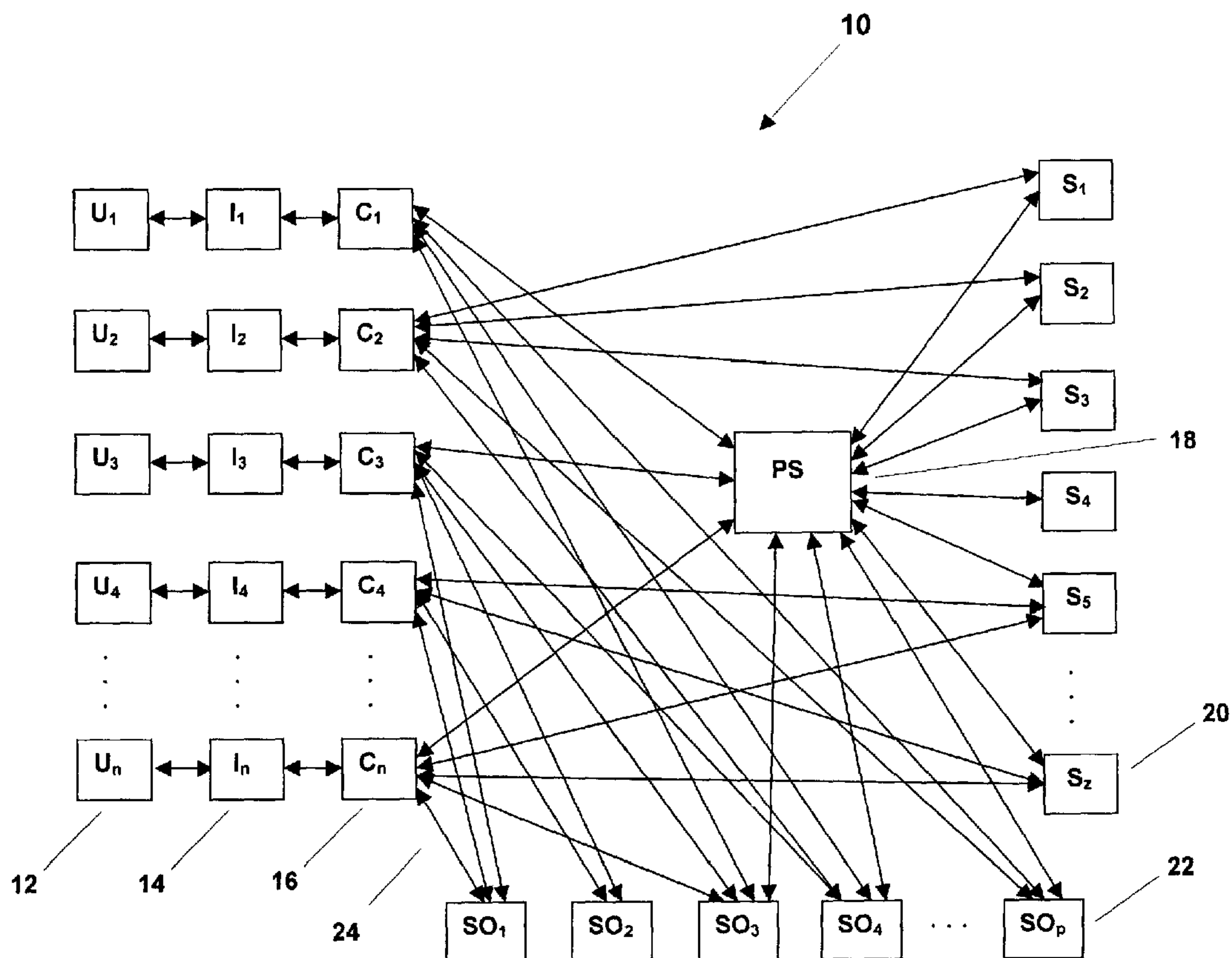

(86) Date de dépôt PCT/PCT Filing Date: 2001/02/22
 (87) Date publication PCT/PCT Publication Date: 2001/08/30
 (85) Entrée phase nationale/National Entry: 2002/08/20
 (86) N° demande PCT/PCT Application No.: US 2001/005926
 (87) N° publication PCT/PCT Publication No.: 2001/063406
 (30) Priorité/Priority: 2000/02/22 (09/510,749) US

(51) Cl.Int.⁷/Int.Cl.⁷ G06F 9/00, G06T 11/00
 (71) Demandeur/Applicant:
LUNENFELD, HARVEY, US
 (72) Inventeur/Inventor:
LUNENFELD, HARVEY, US
 (74) Agent: MCFADDEN, FINCHAM

(54) Titre : FONCTIONNEMENT MULTITACHE CLIENT-SERVEUR
 (54) Title: CLIENT-SERVER MULTITASKING



(57) Abrégé/Abstract:

A client-server multitasking system (10) and process capable of information and/or service retrieval from the same and/or different ones of servers (18) substantially simultaneously and on-the-fly, using the same and/or different ones of queries of the same and/or different ones of the servers (18), and sorting, grouping, and/or organizing responses therefrom substantially on-

(57) **Abrégé(suite)/Abstract(continued):**

the-fly, and communicating service and/or information responses to the requestors (12) and/or users (16) substantially simultaneously and on-the-fly. The client-server multitasking system (10) and process are capable of use on a variety of networks, such as global area networks, and in particular the internet, metropolitan area networks, wide area networks, and local area networks, and are capable of searching search engines and/or other sites substantially simultaneously and on-the-fly. The client-server multitasking system (10) and process are capable of sorting, grouping, and/or organizing results therefrom the servers, search engines, and/or sites, in accordance with instructions from the requestors (12), and/or users, and/or instructions resident within the client-server multitasking system (10) and/or process. The client-server multitasking system (10) and process are capable of use in a variety of applications, and capable of information comparison and/or trend analysis of information from the same and/or different sources substantially simultaneously. The client-server multitasking system (10) and process are capable of building a client-server multitasking system search engine and/or database therefrom responses returned from the servers (18), search engines, and/or sites being queried and/or searched, and/or having requests (29) made thereof, is capable of being searched and/or queried, querying sites referenced therein the client-server multitasking system search engine and/or database, and updating information and/or services stored therein.

(12) INTERNATIONAL APPLICATION PUBLISHED UNDER THE PATENT COOPERATION TREATY (PCT)

(19) World Intellectual Property Organization
International Bureau(43) International Publication Date
30 August 2001 (30.08.2001)

PCT

(10) International Publication Number
WO 01/63406 A1(51) International Patent Classification⁷: G06F 9/00,
G06T 11/00

(21) International Application Number: PCT/US01/05926

(22) International Filing Date: 22 February 2001 (22.02.2001)

(25) Filing Language: English

(26) Publication Language: English

(30) Priority Data:
09/510,749 22 February 2000 (22.02.2000) US

(71) Applicant and

(72) Inventor: LUNENFELD, Harvey [US/US]; 8 Patrician
Drive, East Northport, NY 11731 (US).(81) Designated States (national): AE, AG, AL, AM, AT, AU,
AZ, BA, BB, BG, BR, BY, BZ, CA, CH, CN, CR, CU, CZ,DE, DK, DM, DZ, EE, ES, FI, GB, GD, GE, GH, GM, HR,
HU, ID, IL, IN, IS, JP, KE, KG, KP, KR, KZ, LC, LK, LR,
LS, LT, LU, LV, MA, MD, MG, MK, MN, MW, MX, MZ,
NO, NZ, PL, PT, RO, RU, SD, SE, SG, SI, SK, SL, TJ, TM,
TR, TT, TZ, UA, UG, US, UZ, VN, YU, ZA, ZW.(84) Designated States (regional): ARIPO patent (GH, GM,
KE, LS, MW, MZ, SD, SL, SZ, TZ, UG, ZW), Eurasian
patent (AM, AZ, BY, KG, KZ, MD, RU, TJ, TM), European
patent (AT, BE, CH, CY, DE, DK, ES, FI, FR, GB, GR, IE,
IT, LU, MC, NL, PT, SE, TR), OAPI patent (BF, BJ, CF,
CG, CI, CM, GA, GN, GW, ML, MR, NE, SN, TD, TG).

Published:

— with international search report

For two-letter codes and other abbreviations, refer to the "Guid-
ance Notes on Codes and Abbreviations" appearing at the begin-
ning of each regular issue of the PCT Gazette.

(54) Title: CLIENT-SERVER MULTITASKING

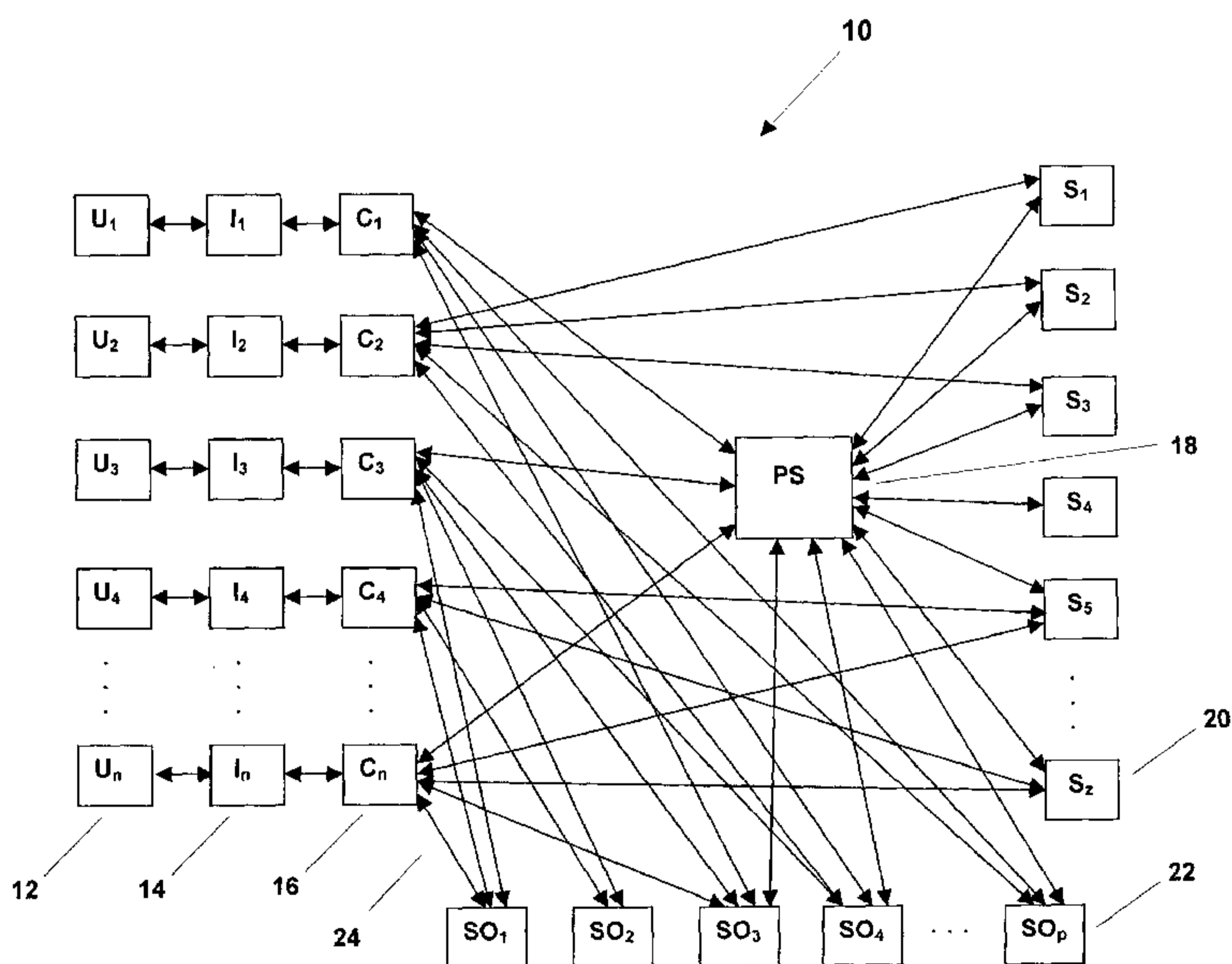
(57) Abstract: A client-server multitask-
ing system (10) and process capable of
information and/or service retrieval from
the same and/or different ones of servers
(18) substantially simultaneously and
on-the-fly, using the same and/or different
ones of queries of the same and/or different
ones of the servers (18), and sorting,
grouping, and/or organizing responses
therefrom substantially on-the-fly, and
communicating service and/or information
responses to the requestors (12) and/or
users (16) substantially simultaneously
and on-the-fly. The client-server
multitasking system (10) and process are
capable of use on a variety of networks,
such as global area networks, and in
particular the internet, metropolitan
area networks, wide area networks, and
local area networks, and are capable of
searching search engines and/or other
sites substantially simultaneously and

on-the-fly. The client-server multitasking system (10) and process are capable of sorting, grouping, and/or organizing results therefrom from the servers, search engines, and/or sites, in accordance with instructions from the requestors (12), and/or users, and/or instructions resident within the client-server multitasking system (10) and/or process. The client-server multitasking system (10) and process are capable of use in a variety of applications, and capable of information comparison and/or trend analysis of information from the same and/or different sources substantially simultaneously. The client-server multitasking system (10) and process are capable of building a client-server multitasking system search engine and/or database therefrom responses returned from the servers (18), search engines, and/or sites being queried and/or searched, and/or having requests (29) made thereof, is capable of being searched and/or queried, querying sites referenced therein the client-server multitasking system search engine and/or database, and updating information and/or services stored therein.

WO 01/63406 A1

Client-Server Multitasking

by

HARVEY LUNENFELD

5 **TABLE OF CONTENTS**

	Table of Contents	1
	Background of the Invention	3
	Field of the Invention	3
10	Background Art	3
	Summary	3
	Drawings	9
	Description	15
	I. System	15
15	A. Overview	15
	E. Optional Database	17
	F. Additional Details	18
	II. A Particular User, User Interface, and Client on the Network	20
	A. Overview	20
20	B. Diagrammatic Regrouping	22
	III. A Particular Service and/or Information Request and Associated Service and/or Information Response on the Network	23
	B. The Server PS (18)	23
	C. Certain Ones of the Clients	27
25	D. Formulating Query Information Groups	32
	IV Process	39
	V. Additional Details	46
	A. User Input	46
	B. User Interface Details	47
30	C. Service and/or Information Request Details	48
	D. Optional Instructions	49
	E. Communicating the Service and/or Information Requests	49
	F. Parsing, Processing, and/or Formatting the Service and/or Information Requests	50
	G. Formulating the Requests	51
35	H. Determining Queries and Servers to Make the Requests Thereof	54
	I. Grouping the Queries and Sorting/Grouping Criteria	56
	J. Communicating the Requests to the Servers	61
	K. Replies from the Servers	63
40	L. Parsing, Processing, Formatting, Sorting, Grouping, and Organizing Responses into Service and/or Information Responses	66

WO 01/63406

PCT/US01/05926

M. Typical Service and/or Information Entry Request Forms, Typical Completed Service and/or Information Entry Request Forms, and Typical Service and/or Information Response Forms 71

N. Additional Features and/or Other Considerations..... 84

Claims 94

5 Abstract 97

Client-Server Multitasking

by

HARVEY LUNENFELD

5

BACKGROUND OF THE INVENTION**FIELD OF THE INVENTION**

10 The present invention relates generally to clients and servers and more particularly to client-server multitasking.

BACKGROUND ART

Clients, servers, and client-server systems have been known. However there is a need for client-server multitasking.

15 A client-server multitasking system and process are needed, which are capable of information and/or service retrieval from the same and/or different ones of servers substantially simultaneously and on-the-fly, using the same and/or different ones of queries, and sorting, grouping, and/or organizing responses therefrom substantially on-the-fly.

SUMMARY

20

The present invention is directed to a client-server multitasking system and process capable of information and/or service retrieval from the same and/or different ones of servers substantially simultaneously and on-the-fly, using the same and/or different ones of queries of the same and/or different ones of the servers, and sorting, grouping, and/or organizing responses therefrom substantially on-the-fly, and communicating service and/or information responses to

25 the requestors and/or users substantially simultaneously and on-the-fly. The client-server multitasking system and process is capable of use on a variety of networks, such as global area networks, and in particular the internet, metropolitan area networks, wide area networks, and local area networks, and be capable of searching search engines and/or other sites substantially simultaneously and on-the-fly.

30 The client-server multitasking system and process is capable of retrieving substantially multiple simultaneous services and/or information having the same and/or different criteria from the same and/or different servers, sorting, grouping, and/or organizing the responses from the servers and/or the clients into information and/or services responses, and communicating the service and/or information responses to the requestors and/or the users substantially simultaneously. The requestors and/or the users may make substantially simultaneous service and/or

35 information requests of servers and clients, using the same and/or different queries, and/or the same and/or different instructions. The same and/or different uniform resource locators, target resources, and/or paths may be used.

The client-server multitasking system and process is capable of making multiple substantially simultaneous same and/or different requests of same and/or different servers, organizing responses from the servers into service and/or

WO 01/63406

PCT/US01/05926

information responses, and communicating the service and/or information responses to the requestors and/or the users substantially simultaneously.

The client-server multitasking system and process is also capable of sorting, grouping, and/or organizing results therefrom the servers, search engines, and/or sites, in accordance with instructions from the requestors and/or the users, and/or instructions resident within the client-server multitasking system and/or process. The client-server multitasking system is capable of use in a variety of applications, and is capable of information comparison and/or trend analysis of information from the same and/or different sources substantially simultaneously. The client-server multitasking system and process is also be capable of building a client-server multitasking system search engine and/or database therefrom responses returned from the servers, search engines, and/or sites being queried and/or searched, and/or having requests made thereof, be capable of being searched and/or queried, querying sites referenced therein the client-server multitasking system search engine and/or database, and updating information and/or services stored therein.

The client-server multitasking system and process are capable of information and/or service retrieval from the same and/or different ones of servers substantially simultaneously and on-the-fly, using the same and/or different ones of queries, and sorting, grouping, and/or organizing responses therefrom substantially on-the-fly.

A requestor and/or user is capable of making substantially multiple simultaneous same and/or different requests of same and/or different servers. The client server-multitasking system and process is capable of organizing responses from the servers into service and/or information responses, and communicating the service and/or information responses to the requestors and/or the users substantially simultaneously, and on-the-fly.

The requestors and/or users are capable of making substantially simultaneous service and/or information requests of the same and/or different ones of servers and/or clients, using the same and/or different queries, and/or the same and/or different instructions. The client-server multitasking system and process is capable of retrieving substantially multiple simultaneous services and/or information having the same and/or different criteria from the same and/or different servers, sorting, grouping, and/or organizing the responses from the servers and/or the clients into information and/or services responses, and communicating the service and/or information responses to the requestors and/or the users substantially simultaneously. The same and/or different ones of uniform resource locators, target resources, and/or paths may be used.

The requestors and/or users are capable of making multiple simultaneous searches. The searches may have at least one or a plurality of same or different queries of the same and/or different servers and/or clients. The responses from the servers and/or the clients may be of being organized into the service and/or information response in a variety of formats. The responses may be sorted within the service and/or information response, such as, for example, by category, query, group, page, order of importance, ascending and/or descending order, alphabetically and/or numerically, or other characteristics, as determined by the requestor, and/or the user, and/or the client-server multitasking system, and/or the responses may be combined within the service and/or information response, such as, for example, interleaving the responses one with the other, such as, for example, by order of relevance or other

WO 01/63406

PCT/US01/05926

parameters. The responses may also be capable of being grouped by search criteria, server, order of importance, or by numerical factors such as value, price, or other numerical quantifier. For example, the responses may be presentable, for example, in ascending or descending order in interleaved format, such as top ones, twos, threes, and so on, or presentable separately to the requestor and/or the user. The order may be order of importance or relevance
5 related, or, for example, numerically valued, such as price or stock market value.

The client-server multitasking system and process is capable of information and/or service retrieval from the same and/or different ones of the servers substantially simultaneously and on-the-fly, using the same and/or different ones of the queries, and sorting, grouping, and/or organizing responses therefrom substantially on-the-fly.

10

The client-server multitasking system and process is capable of substantially multiple simultaneous searching, using the same and/or different ones of queries of the same and/or different ones of the clients and/or servers, which may be search engines, and/or sites, and/or servers, and/or locations on the network, and additionally and/or alternatively building a client-server multitasking search engine and/or database. The client-server multitasking search engine
15 and/or database is capable of storing the information and/or services retrieved therefrom the search engines, and/or sites, and/or servers, and/or locations being queried on the network therein, and building the client-server search engine and/or database. The client-server multitasking search engine should is also capable of being queried either directly and/or in combination therewith the substantially simultaneous searching, using the same and/or different queries of the same and/or different search engines, sites, servers, and/or databases. The client-server multitasking
20 search engine and/or database should is also capable of updating information and/or services stored therein by querying sites, servers, search engines, and/or databases containing information and/or services referenced in client-server multitasking search engine and/or database.

The client-server multitasking system and process is also capable of use on a variety of networks, such as global area
25 networks, and in particular the internet, metropolitan area networks, wide area networks, and local area networks.

The client-server multitasking system and process are capable of substantially simultaneous searching of the same and/or different ones of search engines and/or sites on the network substantially on-the-fly, with the same and/or different ones of the queries, and sorting, grouping, and/or organizing responses therefrom substantially on-the-fly.

30

The client-server multitasking system and process are also capable of sorting, grouping, and/or organizing results therefrom the servers, search engines, and/or sites, in accordance with instructions from the requestors, and/or instructions resident within the client-server multitasking system and/or process. The client-server multitasking system and process are also capable drilling down and/or up to different levels within the search engines, sites,
35 and/or servers being queried.

The client-server multitasking system and process are capable of providing manual and/or timed updates. Such
timed updates allow for motion related presentation to the requestor and/or the user.

WO 01/63406

PCT/US01/05926

The client-server multitasking system and process are capable of incorporating information and/or services thereinto a variety of user interfaces at different locations therein the user interfaces, grouping, and/or organizing the information and/or services, and optionally eliminating duplicate information and/or services.

- 5 The client-server multitasking system and process are capable of incorporating links, graphics, video, text, and audio, and/or combinations thereof, and selective advertising, according to selectable search, query, sorting, and/or grouping criteria, and/or combinations thereof thereinto the information and/or services to be delivered thereto the user interfaces. The requestor and/or the user may place orders, such as purchases, and/or other types of orders, payments, confirmations thereof, and/or combinations thereof, either directly and/or therethrough servers and/or sites
10 thereon the network.

The client-server multitasking system is capable of use in a variety of applications, and is capable of information comparison and/or trend analysis of information from the same and/or different sources substantially simultaneously. The client-server multitasking system is capable of, for example, determining best query results, with respect to a
15 plurality of search engine results; purchasing and/or price comparisons, viewing and/or reviewing prices/values and trends for different sites, determining lowest costs and lowest cost analyses for wholesale and retail purposes; product availability, e.g., airline tickets, pricing, and ticket availability, from different airlines to the same and/or different locations; purchasing of commodities and/or stocks from the same and/or different sites with updates every few seconds and/or minutes; obtaining prices and/or values in different stock markets substantially simultaneously;
20 and searching for jobs on the same and/or different job sites, using the same and/or different job criteria, for example, on a daily basis, the job sites having changing job availability; and/or a combination thereof, all substantially simultaneously. The client-server multitasking system is capable of presenting information and/or services for review and/or updating from the same and/or different ones of sites, servers, and/or applications substantially simultaneously, and trend analysis thereof, using a variety of sorting, grouping and/or organizing
25 criteria, according to the needs of the requestor, and/or the user, and/or resident within the client-server multitasking system.

The client server-multitasking system and process are capable of service and/or information retrieval from at least one server, organization, communication, and presentation of such services and/or information to at least one
30 requestor and/or user, and/or optional storage, and/or retrieval of such services and/or information from the optional storage. The client-server multitasking system and process are capable of building a client-server multitasking system search engine and/or database therefrom responses returned from the servers, search engines, and/or sites being queried and/or searched, and/or having requests made thereof. The client-server multitasking system search engine and/or database having stored information and/or services therein are also searchable, are capable of full text
35 searches thereof, and are searchable by the servers and/or the clients on the network, either separately and/or in combination therewith the substantially simultaneous multiple same and/or different searches and/or queries of the same and/or different servers on the network. Information therein the client-server multitasking system search engine and/or database are also searchable and/or retrievable, and are capable of being incorporated therein the service and/or information responses delivered thereto the user interfaces, according to search criteria, selectively
40 and/or automatically, by the requestor and/or the user. The client-server multitasking system search engine and/or

WO 01/63406

PCT/US01/05926

database are capable of spidering, and/or roboting, and/or querying sites, services and/or information to be stored therein and/or stored therein the client-server multitasking system search engine and/or database, and updating the services and/or information to be stored and/or stored therein the client-server multitasking system search engine and/or database.

5

The client-server multitasking system and process are capable of retrieving, parsing, processing, formatting, organizing, grouping, sorting, and consolidating services and/or information therefrom the same and/or different ones of the servers and/or clients having the same and/or different structures, formats, organizations, groupings, and/or data structures, and incorporating the parsed, processed, formatted, organized, grouped, sorted, and

10 consolidated services and/or information thereinto user responses for delivery to and use by the requestors and/or users.

The client-server multitasking system and process, then, are capable of information and/or service retrieval from the same and/or different ones of servers substantially simultaneously and on-the-fly, using the same and/or different

15 ones of queries of the same and/or different ones of the servers, and sorting, grouping, and/or organizing responses therefrom substantially on-the-fly, and communicating service and/or information responses to the requestors and/or users substantially simultaneously and on-the-fly. The client-server multitasking system and process are capable of use on a variety of networks, such as global area networks, and in particular the internet, metropolitan area networks, wide area networks, and local area networks, and are capable of searching search engines and/or other sites

20 substantially simultaneously and on-the-fly. The client-server multitasking system and process are capable of sorting, grouping, and/or organizing results therefrom the servers, search engines, and/or sites, in accordance with instructions from the requestors, and/or users, and/or instructions resident within the client-server multitasking system and/or process. The client-server multitasking system is capable of use in a variety of applications, and capable of information comparison and/or trend analysis of information from the same and/or different sources

25 substantially simultaneously. The client-server multitasking system and process are capable of building a client-server multitasking system search engine and/or database therefrom responses returned from the servers, search engines, and/or sites being queried and/or searched, and/or having requests made thereof, is capable of being searched and/or queried, querying sites referenced therein the client-server multitasking system search engine and/or database, and updating information and/or services stored therein. The client-server multitasking system and process

30 are capable of retrieving, parsing, processing, formatting, organizing, grouping, sorting, and consolidating services and/or information therefrom the same and/or different ones of the servers and/or clients having the same and/or different structures, formats, organizations, groupings, and/or data structures, and incorporating the parsed, processed, formatted, organized, grouped, sorted, and consolidated services and/or information thereinto user responses for delivery to and use by the requestors and/or users.

35

The client-server multitasking system and process are also capable of performing as a multiple query search engine, which performs multiple queries of multiple sites, and of performing as a single point of sale for purchasing multiple products from multiple sources.

WO 01/63406

PCT/US01/05926

A multitasking process having features of the present invention comprises: parsing, processing, and/or formatting a service and/or information request thereinto a current request group; opening connections therewith and making at least one request thereof at least one server; parsing, processing, formatting, grouping, and/or organizing at least one response therefrom the at least one server thereinto at least one addressable response information group; formulating
5 information therefrom the current request group thereinto a request pointer/address group having at least one pointer/address; formulating at least one addressable query pointer/address group having at least one other pointer/address; incorporating information and/or services therefrom the at least one addressable response information group thereinto at least one addressable query information group; and incorporating the at least one addressable query information group thereinto a service and/or information response.

10

A client-server multitasking system having features of the present invention comprises: means for parsing, processing, and/or formatting a service and/or information request thereinto a current request group; means for opening connections therewith and making at least one request thereof at least one server; means for parsing, processing, formatting, grouping, and/or organizing at least one response therefrom the at least one server thereinto
15 at least one addressable response information group; means for formulating information therefrom the current request group thereinto a request pointer/address group having at least one pointer/address; means for formulating at least one addressable query pointer/address group having at least one other pointer/address; means for incorporating information and/or services therefrom the at least one addressable response information group thereinto at least one addressable query information group; and means for incorporating the at least one addressable query information
20 group thereinto a service and/or information response.

DRAWINGS

These and other features, aspects, and advantages of the present invention will become better understood with regard to the following description, appended claims, and accompanying drawings where:

- 5 FIG. 1 is a schematic representation of a client-server multitasking system, constructed in accordance with the present invention;
- FIG. 2 is a more detailed schematic representation of the client-server multitasking system;
- FIG. 3 is a schematic representation of user input UI_n from user U_n thereinto user interface I_n of the client-server multitasking system;
- 10 FIG. 4 is a schematic representation of a server S_z of the client-server multitasking system;
- FIG. 5A is a schematic representation of a server PS of the client-server multitasking system having an optional database;
- FIG. 5B is a schematic representation of a client C_n of the client-server multitasking system having an optional database;
- 15 FIG. 6 is a schematic representation of a particular one of the clients $C_1...C_n$ of the client-server multitasking system, designated as the particular client C_n , communicating with ones of the servers $S_1...S_z$, in accordance with the designation scheme corresponding to the corresponding ones of the server designations $S_{n1}...S_{nm}$, corresponding to the requests $Q_{n1}...Q_{nm}$, therethrough the server PS ;
- FIG. 7 is a schematic representation of the particular client C_n of the client-server multitasking system
- 20 communicating with ones of the servers $S_1...S_z$, in accordance with the designation scheme corresponding to the corresponding ones of the server designations $S_{n1}...S_{nm}$, corresponding to the requests $Q_{n1}...Q_{nm}$;
- FIG. 8 is a schematic representation of the particular client C_n of the client-server multitasking system communicating with ones of the servers $S_1...S_z$, in accordance with the designation scheme
- 25 corresponding to the corresponding ones of the server designations $S_{n1}...S_{nm}$, corresponding to the requests $Q_{n1}...Q_{nm}$, and also therethrough the server PS ;
- FIG. 9 is an alternate schematic representation of the client-server multitasking system of FIG.1, constructed in accordance with the present invention, regrouped diagrammatically and alternatively named for illustrative purposes only, to illustrate and visualize possible typical communication paths;
- 30 FIG. 10 is a schematic representation of a particular service and/or information request IQ_n ;
- FIG. 11 is a schematic representation of a particular service and/or information request IQ_n parsed, processed, and/or formatted into a current request group QA_{nc} , request groups $QA_{n1}...QA_{nz}$, and corresponding optional instructions $VJ_{n1}...VJ_{nk}$, and utilization of information therefrom to make the requests $Q_{n1}...Q_{nm}$, obtain the responses $R_{n1}...R_{nm}$, and incorporate information therefrom into a particular
- 35 service and/or information response IR_n ;
- FIG. 12 is a schematic representation of the particular service and/or information request IQ_n parsed, processed, and/or formatted into a current request group QA_{nc} , request groups $QA_{n1}...QA_{nz}$, and corresponding optional instructions $VJ_{n1}...VJ_{nk}$, and utilization of information therefrom to make the requests $Q_{n1}...Q_{nm}$, obtain the responses $R_{n1}...R_{nm}$, and incorporate information therefrom into the particular

service and/or information response \mathbf{IR}_n , having other grouping/sorting that may be used additionally and/or alternatively to that of FIG. 11;

FIG. 13 is a schematic representation of the particular service and/or information response \mathbf{IR}_n having a service and/or information group \mathbf{G}_n , additional request links $\mathbf{SL}_{n1} \dots \mathbf{SL}_{nw}$, optional order form, optional
5 additional advertisements and/or links, optional hidden information, and the optional service and/or information entry request form;

FIG. 14 is a schematic representation of a particular user service and/or information request \mathbf{iq}_n ;

FIG. 15 is a schematic representation of a particular user service and/or information request \mathbf{iq}_n parsed,
10 processed, and/or formatted into the current request group \mathbf{QA}_{nc} , the request groups $\mathbf{QA}_{n1} \dots \mathbf{QA}_{nz}$, and the corresponding optional instructions $\mathbf{VJ}_{n1} \dots \mathbf{VJ}_{nk}$, and utilization of information therefrom to make the requests $\mathbf{Q}_{n1} \dots \mathbf{Q}_{nm}$, obtain the responses $\mathbf{R}_{n1} \dots \mathbf{R}_{nm}$, and incorporate information therefrom into the particular user service and/or information response \mathbf{ir}_n ;

FIG. 16 is a schematic representation of the particular user service and/or information request \mathbf{iq}_n parsed,
15 processed, and/or formatted into the current request group \mathbf{QA}_{nc} , the request groups $\mathbf{QA}_{n1} \dots \mathbf{QA}_{nz}$, and the corresponding optional instructions $\mathbf{VJ}_{n1} \dots \mathbf{VJ}_{nk}$, and utilization of information therefrom to make the requests $\mathbf{Q}_{n1} \dots \mathbf{Q}_{nm}$, obtain the responses $\mathbf{R}_{n1} \dots \mathbf{R}_{nm}$, and incorporate information therefrom into the particular user service and/or information response \mathbf{ir}_n , having other grouping/sorting that may be used additionally and/or alternatively to that of FIG. 15;

FIG. 17 is a schematic representation of the particular user service and/or information response \mathbf{ir}_n having the
20 service and/or information group \mathbf{G}_n , the additional request links $\mathbf{SL}_{n1} \dots \mathbf{SL}_{nw}$, the optional order form, the optional additional advertisements and/or links, the optional hidden information, and the optional service and/or information entry request form;

FIG. 18A is a schematic representation of a response information group \mathbf{RG}_{nm} having addressable individual
25 information groups $\mathbf{LG}_{nm1} \dots \mathbf{LG}_{nmr}$ showing optional addressable pointer/address indices $\mathbf{IN}_{nm1} \dots \mathbf{IN}_{nmr}$ correspondingly associated therewith optional addressable individual information groups $\mathbf{LG}_{nm1} \dots \mathbf{LG}_{nmr}$, which may be addressed/pointed therewith pointer/address \mathbf{PP}_{nm1} ;

FIG. 18B is a schematic representation of the addressable response information group \mathbf{RG}_{nm} having the
30 addressable individual information groups $\mathbf{LG}_{nm1} \dots \mathbf{LG}_{nmr}$ showing the optional addressable pointer/address indices $\mathbf{IN}_{nm1} \dots \mathbf{IN}_{nmr}$ correspondingly associated therewith the optional addressable individual information groups $\mathbf{LG}_{nm1} \dots \mathbf{LG}_{nmr}$, which may be addressed/pointed therewith the pointer/address \mathbf{PP}_{nm2} ;

FIG. 18C is a schematic representation of the addressable response information group \mathbf{RG}_{nm} having the
35 addressable individual information groups $\mathbf{LG}_{nm1} \dots \mathbf{LG}_{nmr}$ showing the optional addressable pointer/address indices $\mathbf{IN}_{nm1} \dots \mathbf{IN}_{nmr}$ correspondingly associated therewith the optional addressable individual information groups $\mathbf{LG}_{nm1} \dots \mathbf{LG}_{nmr}$, which may be addressed/pointed therewith the pointer/address \mathbf{PP}_{nmr} ;

FIG. 19 is a schematic representation of the individual information groups $\mathbf{LG}_{nm1} \dots \mathbf{LG}_{nmr}$ having
corresponding optional links $\mathbf{LD}_{nm1} \dots \mathbf{LD}_{nmr}$, and/or corresponding optional descriptions

$DD_{nm1} \dots DD_{nmr}$, and/or corresponding optional prices/values $PD_{nm1} \dots PD_{nmr}$, and/or corresponding optional images $ID_{nm1} \dots ID_{nmr}$;

FIG. 20 is a schematic representation of a labelled individual information group LL_{nmr} ;

FIG. 21 is a schematic representation of an addressable query information group GI_{nz} ;

5 FIG. 22 is a schematic representation of steps of a client-server multitasking process of the present invention;

FIG. 22-1A is a schematic representation of a multitasking process of deriving the service and/or information response IR_n and/or the user service and/or information response ir_n , with reference to FIGS. 11 and 15;

FIG. 22-1B is a schematic representation of a multitasking process of deriving the service and/or information response IR_n and/or the user service and/or information response ir_n having other grouping/sorting that

10 may be used additionally and/or alternatively to that of FIGS. 11 and 15, as shown with reference to FIGS. 12 and 16;

FIG. 22-1-1 is a schematic representation of a step of the multitasking process of FIGS. 22-1A and 22-1B shown in more detail;

FIG. 22-1-2A is a schematic representation of another step of the multitasking process of FIG. 22-1A shown in

15 more detail;

FIG. 22-1-2B is a schematic representation of another step of the multitasking process of FIG. 22-1B shown in more detail;

FIG. 22-2 is a schematic representation of user review of user response UR_n and/or selection of additional services and/or information;

20 FIG. 23 is a schematic representation showing queries $QQ_{n1} \dots QQ_{nm}$ and corresponding server addresses $AQ_{n1} \dots AQ_{nm}$;

FIG. 24 is a schematic representation of queries $QQ_{n1} \dots QQ_{nm}$, corresponding server addresses $AQ_{n1} \dots AQ_{nm}$, and optional instructions $VJ_{nm1} \dots VJ_{nk}$ that may be parsed, processed, and/or formatted from the service and/or information request IQ_n and/or the user service and/or information request iq_n , shows a schematic representation of a typical one of the optional service and/or information entry request form IE_n , and is

25 schematically representational of a typical user interface I_n ,

FIG. 25 is a schematic representation of certain typical optional instructions $VJ_{nm1} \dots VJ_{nk}$ and/or certain additional request links $SL_{n1} \dots SL_{nw}$;

FIG. 26 is a schematic representation of other certain typical optional instructions $VJ_{nm1} \dots VJ_{nk}$ and/or other

30 certain additional request links $SL_{n1} \dots SL_{nw}$;

FIG. 27 depicts certain typical additional request links $SL_{n1} \dots SL_{nw}$;

FIG. 28 is a schematic representation of a request pointer/address group QZ_{ns} , having a particular one of query pointer/address groups $QG_{n1} \dots QG_{nz}$, designated as the query pointer/address group QG_{nz} , associated ones of the addressable response information groups $RG_{n1} \dots RG_{nm}$, the pointers/addresses $PP_{n11} \dots PP_{nmr}$, and the query information group GI_{nz} associated therewith the query pointer/address group QG_{nz} ;

35

FIG. 29 is a schematic representation of a sorting criteria addressing scheme having a particular query pointer/address group QG_{nz} , associated ones of response information groups RG_{nm} , and query information group GI_{nz} associated therewith the query pointer/address group QG_{nz} ;

FIG. 30 is a schematic representation of an alternate sorting criteria addressing scheme having a particular query pointer/address group \mathbf{QG}_{nz} , associated ones of response information groups \mathbf{RG}_{nm} , and query information group \mathbf{GI}_{nz} associated therewith the query pointer/address group \mathbf{QG}_{nz} ;

FIG. 31 is a schematic representation of typical ones of the query pointer/address groups $\mathbf{QG}_{n1} \dots \mathbf{QG}_{nz}$, having the sorting criteria addressing scheme of FIG. 29, having typical ones of queries $\mathbf{QQ}_{n1} \dots \mathbf{QQ}_{nz}$ and corresponding server addresses $\mathbf{AQ}_{n1} \dots \mathbf{AQ}_{nz}$ associated therewith;

FIG. 32 is another schematic representation of the typical ones of the query pointer/address groups $\mathbf{QG}_{n1} \dots \mathbf{QG}_{nz}$, having the sorting criteria addressing scheme of FIG. 29, having the typical ones of the queries $\mathbf{QQ}_{n1} \dots \mathbf{QQ}_{nz}$ and the corresponding ones of the server addresses $\mathbf{AQ}_{n1} \dots \mathbf{AQ}_{nz}$ of FIG. 31 associated therewith;

FIG. 33 is a generic schematic representation of the query pointer/address groups $\mathbf{QG}_{n1} \dots \mathbf{QG}_{nz}$, having the sorting criteria addressing scheme of FIG. 29, having the ones of queries $\mathbf{QQ}_{n1} \dots \mathbf{QQ}_{nz}$ and the corresponding ones of the server addresses $\mathbf{AQ}_{n1} \dots \mathbf{AQ}_{nz}$ associated therewith;

FIG. 34 is a schematic representation of a request \mathbf{Q}_{nm} of the client-server multitasking system;

FIG. 35 is a schematic representation of a response \mathbf{R}_{nm} of the client-server multitasking system;

FIG. 36 is a schematic representation of an entity body \mathbf{RH}_{nm} of the response \mathbf{R}_{nm} of FIG. 35 having optional response individual information groups $\mathbf{LS}_{nm1} \dots \mathbf{LS}_{nmr}$, and/or optional information \mathbf{LI}_{nm} ;

FIG. 37 is a schematic representation of the addressable response information group \mathbf{RG}_{nm} having the addressable individual information groups $\mathbf{LG}_{nm1} \dots \mathbf{LG}_{nmr}$ parsed, and/or processed, and/or formatted, and/or organized, and/or grouped thereinto the addressable response information group \mathbf{RG}_{nm} therefrom the optional entity body \mathbf{RH}_{nm} of FIG. 36;

FIG. 38 is a schematic representation of the optional response individual information group \mathbf{LS}_{nmr} parsed, and/or processed, and/or formatted, and/or organized, and/or grouped thereinto the addressable individual information group \mathbf{LG}_{nmr} ;

FIG. 39 is a schematic representation of the optional links $\mathbf{LD}_{nm1} \dots \mathbf{LD}_{nmr}$, and/or the optional descriptions $\mathbf{DD}_{nm1} \dots \mathbf{DD}_{nmr}$, and/or the optional prices/values $\mathbf{PD}_{nm1} \dots \mathbf{PD}_{nmr}$, and/or the optional images $\mathbf{ID}_{nm1} \dots \mathbf{ID}_{nmr}$ parsed individually and/or separately, and incorporated thereinto the addressable response information group \mathbf{RG}_{nm} therefrom the optional entity body \mathbf{RH}_{nm} ;

FIGS. 40 is a schematic representation of a typical one of the addressable query information group \mathbf{GI}_{nz} , based upon certain sorting and/or grouping criteria, having the labelled individual information groups $\mathbf{LL}_{nz1} \dots \mathbf{LL}_{nzu}$, the optional database labelled individual information groups $\mathbf{RL}_{nz1} \dots \mathbf{RL}_{nzx}$, the optional query description \mathbf{QT}_{nz} , the optional server descriptions and/or links $\mathbf{ST}_{nz1} \dots \mathbf{ST}_{nzf}$, and the optional advertisements and/or links $\mathbf{LT}_{nz1} \dots \mathbf{LT}_{nzt}$ incorporated thereinto certain typical ones of the typical service and/or information response forms \mathbf{IS}_n ; and

FIGS. 41 is a another schematic representation of a typical one of the addressable query information group \mathbf{GI}_{nz} , based upon certain sorting and/or grouping criteria, having the labelled individual information groups $\mathbf{LL}_{nz1} \dots \mathbf{LL}_{nzu}$, the optional database labelled individual information groups $\mathbf{RL}_{nz1} \dots \mathbf{RL}_{nzx}$, the optional query description \mathbf{QT}_{nz} , the optional server descriptions and/or links $\mathbf{ST}_{nz1} \dots \mathbf{ST}_{nzf}$, and the optional

advertisements and/or links $LT_{nz1} \dots LT_{nzt}$ incorporated therein certain typical ones of the typical service and/or information response forms IS_n ;

FIG. 42 depicts a typical service and/or information entry request form IE_n at the user interface I_n , which the user U_n may communicate typical user input UI_n thereinto;

5 FIG. 43 depicts a typical completed service and/or information entry request form IF_n at the user interface I_n ;

FIG. 44 depicts a typical user response UR_n , as a typical service and/or information response form IS_n at the user interface I_n , which may be communicated thereto the user U_n ;

FIG. 45 depicts another typical user response UR_n , as the typical service and/or information response form IS_n at the user interface I_n , which may be communicated thereto the user U_n ;

10 FIG. 46 depicts another typical user response UR_n , as the typical service and/or information response form IS_n at the user interface I_n , which may be communicated thereto the user U_n ;

FIG. 47 depicts another typical completed service and/or information entry request form IF_n at the user interface I_n ;

15 FIG. 48 depicts another typical user response UR_n , as the typical service and/or information response form IS_n at the user interface I_n , which may be communicated thereto the user U_n ;

FIG. 49 depicts another typical user response UR_n , as the typical service and/or information response form IS_n at the user interface I_n , which may be communicated thereto the user U_n ;

FIG. 50 depicts another typical user response UR_n , as the typical service and/or information response form IS_n at the user interface I_n , which may be communicated thereto the user U_n ;

20 FIG. 51 depicts another typical completed service and/or information entry request form IF_n at the user interface I_n ;

FIG. 52 depicts another typical user response UR_n , as the typical service and/or information response form IS_n at the user interface I_n , which may be communicated thereto the user U_n ;

25 FIG. 53 depicts another typical completed service and/or information entry request form IF_n at the user interface I_n ;

FIG. 54 depicts another typical user response UR_n , as the typical service and/or information response form IS_n at the user interface I_n , which may be communicated thereto the user U_n ;

FIG. 55 depicts another typical completed service and/or information entry request form IF_n at the user interface I_n ;

30 FIG. 56 depicts another typical user response UR_n , as the typical service and/or information response form IS_n at the user interface I_n , which may be communicated thereto the user U_n ;

FIG. 57 depicts another typical completed service and/or information entry request form IF_n at the user interface I_n ;

35 FIG. 58 depicts another typical user response UR_n , as the typical service and/or information response form IS_n at the user interface I_n , which may be communicated thereto the user U_n ;

FIG. 59 depicts another typical completed service and/or information entry request form IF_n at the user interface I_n ;

FIG. 60 depicts a typical combined user response UR_n , as the typical service and/or information response form IS_n at the user interface I_n , which may be communicated thereto the user U_n , and an order entry form OF_n , which the user U_n may enter an order therewith;

FIG. 61 depicts a typical preview form of an order OP_n , resulting from submission of the order entry form OF_n , of the typical combined user response UR_n , as the typical service and/or information response form IS_n at the user interface I_n , which may be communicated thereto the user U_n , and the order entry form OF_n , which the user U_n may enter the order therewith, of FIG. 54;

FIG. 62 depicts a typical order placement form OL_n , having the typical preview form of the order OP_n , resulting from submission of the order entry form OF_n , of the typical combined user response UR_n , as the typical service and/or information response form IS_n at the user interface I_n , which may be communicated thereto the user U_n , and the order entry form OF_n , which the user U_n may enter the order therewith, of FIG. 54, or which the user U_n may enter therethrough the typical preview form of the order OP_n of FIG. 61;

FIG. 63 depicts a typical order confirmation OC_n , resulting from submission of the typical completed order placement form OL_n of FIG. 62;

FIG. 64 depicts another typical service and/or information entry request form IE_n at the user interface I_n , which the user U_n may communicate other typical user input UI_n thereinto;

FIG. 65 depicts another typical service and/or information entry request form IE_n at the user interface I_n , which the user U_n may communicate other typical user input UI_n thereinto;

FIG. 66 depicts another typical completed service and/or information entry request form IF_n at the user interface I_n ;

FIG. 67 depicts another typical user response UR_n , as the typical service and/or information response form IS_n at the user interface I_n , which may be communicated thereto the user U_n ;

FIG. 68 depicts another typical service and/or information entry request form IE_n at the user interface I_n , which the user U_n may communicate other typical user input UI_n thereinto;

FIG. 69 depicts another typical user response UR_n , as the typical service and/or information response form IS_n at the user interface I_n , which may be communicated thereto the user U_n ; and

FIG. 70 depicts another typical service and/or information entry request form IE_n at the user interface I_n , which the user U_n may communicate other typical user input UI_n thereinto.

DESCRIPTION

The preferred embodiments of the present invention will be described with reference to FIGS. 1-70 of the drawings.

5 Identical elements in the various figures are identified with the same reference alphanumeric.

I. SYSTEM

A. OVERVIEW

FIGS. 1 and 2 show a client-server multitasking system **10** of the present invention, having requestors **U₁...U_n (12)**, hereinafter called users **U₁...U_n (12)**, corresponding user interfaces **I₁...I_n (14)**, corresponding clients **C₁...C_n (16)**, server **PS (18)**, servers **S₁...S_z (20)**, and optional servers **SO₁...SO_p (22)**, constructed in accordance with the present invention, which reside on a network **24**. Each of the users **U₁...U_n (12)** communicate with the corresponding clients **C₁...C_n (16)** therethrough the corresponding user interfaces **I₁...I_n (14)**.

15 Each of the users **U₁...U_n (12)** enter corresponding user inputs **UI₁...UI_n (25)** having one or more same and/or different user requests **qu₁₁...qu_{nu} (26)** thereinto the corresponding user interfaces **I₁...I_n (14)**, as shown in FIG. 3. The user requests **qu₁₁...qu_{nu} (26)** are communicated from the user interfaces **I₁...I_n (14)** to the corresponding clients **C₁...C_n (16)** within corresponding user service and/or information requests **iq₁...iq_n (27)**, having the user requests **qu₁₁...qu_{nu} (26)** and other optional information. The users **U₁...U_n (12)** may enter the corresponding user
20 inputs **UI₁...UI_n (25)** at the same and/or different times.

Each of the user interfaces **I₁...I_n (14)** communicate the user service and/or information requests **iq₁...iq_n (27)** thereto the corresponding clients **C₁...C_n (16)**, which optionally format the corresponding user service and/or information requests **iq₁...iq_n (27)** into corresponding service and/or information requests **IQ₁...IQ_n (28)**, as
25 required. Each of the service and/or information requests **IQ₁...IQ_n (28)** have information therein that may be used to formulate one or more same and/or different requests **Q₁₁...Q_{nm} (29)** to be made of one or more of the same and/or different ones of the servers **S₁...S_z (20)**, which may hereinafter be called server designations **S₁₁...S_{nm} (30)**, in accordance with a designation scheme which designates the servers **S₁...S_z (20)** to be communicated with corresponding to the requests **Q₁₁...Q_{nm} (29)** as the corresponding server designations **S₁₁...S_{nm} (30)**, as shown in
30 FIGS. 2 and 4. FIG. 4 shows the server designations **S₁₁...S_{nm} (30)** for typical ones of the requests **Q₁₁...Q_{nm} (29)** and a typical one of the servers **S_z (20)**. Each of the requests **Q₁₁...Q_{nm} (29)** may be the same and/or different one from the other and may be made of the same and/or different ones of the servers **S₁...S_z (20)** at the same time and/or different times.

35 Each of the service and/or information requests **IQ₁...IQ_n (28)** may be communicated thereto the server **PS (18)**, which parses, processes, and/or formats the service and/or information requests **IQ₁...IQ_n (28)** into the requests **Q₁₁...Q_{nm} (29)**.

The corresponding clients $C_1 \dots C_n$ (16) may also and/or alternatively optionally parse, process, and/or format the corresponding user service and/or information requests $iq_1 \dots iq_n$ (27) into one or more of the same and/or different requests $Q_{11} \dots Q_{nm}$ (29) to be made of one or more of the same and/or different ones of the servers $S_1 \dots S_z$ (20), in accordance with the designation scheme corresponding to the corresponding ones of the server designations

5 $S_{11} \dots S_{nm}$ (30), as required.

Certain ones of the clients $C_1 \dots C_n$ (16) may communicate corresponding certain ones of the service and/or information requests $IQ_1 \dots IQ_n$ (28) to the server PS (18), which parses, processes and/or formats the certain ones of the service and/or information requests $IQ_1 \dots IQ_n$ (28) into certain ones of the requests $Q_{11} \dots Q_{nm}$ (29), as

10 required, and communicates the certain ones of the requests $Q_{11} \dots Q_{nm}$ (29) to the servers $S_1 \dots S_z$ (20), in accordance with the designation scheme corresponding to the corresponding certain ones of the server designations $S_{11} \dots S_{nm}$ (30).

Alternate ones of the clients $C_1 \dots C_n$ (16) may communicate corresponding alternate ones of the requests $Q_{11} \dots Q_{nm}$ (29) to corresponding alternate ones of the servers $S_1 \dots S_z$ (20), in accordance with the designation scheme corresponding to the corresponding alternate ones of the server designations $S_{11} \dots S_{nm}$ (30).

15

Other alternate ones of the clients $C_1 \dots C_n$ (16) may communicate corresponding other alternate ones of the service and/or information requests $IQ_1 \dots IQ_n$ (28) to the server PS (18), which parses, processes and/or formats the other alternate ones of the service and/or information requests $IQ_1 \dots IQ_n$ (28) into other alternate ones of the requests $Q_{11} \dots Q_{nm}$ (29), as required, communicates the other alternate ones of the requests $Q_{11} \dots Q_{nm}$ (29) to corresponding other alternate ones of the servers $S_1 \dots S_z$ (20), in accordance with the designation scheme corresponding to the corresponding other alternate ones of the server designations $S_{11} \dots S_{nm}$ (30); and additionally the other alternate ones of the clients $C_1 \dots C_n$ (16) may also parse, process, and/or format the user service and/or information requests

20 $iq_1 \dots iq_n$ (27) into one or more of the same and/or different yet other alternate ones of the requests $Q_{11} \dots Q_{nm}$ (29), and communicate the yet other alternate ones of the requests $Q_{11} \dots Q_{nm}$ (29) to corresponding yet other alternate ones of the servers $S_1 \dots S_z$ (20), in accordance with the designation scheme corresponding to the corresponding yet other alternate ones of the server designations $S_{11} \dots S_{nm}$ (30).

30 Each of the service and/or information requests $IQ_1 \dots IQ_n$ (28) may, thus, be communicated therefrom the corresponding clients $C_1 \dots C_n$ (16) to the server PS (18). The requests $Q_{11} \dots Q_{nm}$ (29) may be communicated therefrom the server PS (18) and/or therefrom the corresponding clients $C_1 \dots C_n$ (16) to the servers $S_1 \dots S_z$ (20), and may depend upon instructions from and/or generated by the corresponding users $U_1 \dots U_n$ (12), and/or the corresponding user interfaces $I_1 \dots I_n$ (14) and/or the corresponding clients $C_1 \dots C_n$ (16), and/or information

35 generated by the server PS (18) and/or the servers $S_1 \dots S_z$ (20), and/or ancillary instructions, a combination thereof, and/or other suitable means.

Each of the servers $S_1 \dots S_z$ (20) corresponding to the designation scheme $S_{11} \dots S_{nm}$ (30) replies to the server PS (18) and/or the clients $C_1 \dots C_n$ (16), accordingly, and communicates corresponding responses $R_{11} \dots R_{nm}$ (32),

associated with the requests $Q_{11}...Q_{nm}$ (29), to the server **PS** (18) and/or the clients $C_1...C_n$ (16) making the requests $Q_{11}...Q_{nm}$ (29), as shown in FIG. 2 for typical ones of the requests $Q_{11}...Q_{nm}$ (29) and the corresponding responses $R_{11}...R_{nm}$ (32).

- 5 The server **PS** (18) and/or the appropriate clients $C_1...C_n$ (16) parse, process, format, sort, group, and/or organize the responses $R_{11}...R_{nm}$ (32) into corresponding service and/or information responses $IR_1...IR_n$ (34), having corresponding parsed, processed, formatted, sorted, grouped, and/or organized service and/or information groups $G_1...G_n$ (35) acceptable to the corresponding clients $C_1...C_n$ (16) and the corresponding respective user interfaces $I_1...I_n$ (14). The server **PS** (18) communicates the appropriate service and/or information responses $IR_1...IR_n$ (34)
10 to the corresponding clients $C_1...C_n$ (16).

- The clients $C_1...C_n$ (16) format the service and/or information responses $IR_1...IR_n$ (34) into corresponding user service and/or information responses $ir_1...ir_n$ (36), as required, and communicate the user service and/or information responses $ir_1...ir_n$ (36) thereto the corresponding user interfaces $I_1...I_n$ (14). The user interfaces $I_1...I_n$ (14)
15 incorporate the user service and/or information responses $ir_1...ir_n$ (36) into corresponding user responses $UR_1...UR_n$ (37), which are derived at the user interfaces $I_1...I_n$ (14), and communicated by the user interfaces $I_1...I_n$ (14) thereto the corresponding users $U_1...U_n$ (12). The users $U_1...U_n$ (12) review the corresponding user responses $UR_1...UR_n$ (37) at the user interfaces $I_1...I_n$ (14) and/or select additional services and/or information therefrom.

20 E. OPTIONAL DATABASE

The server **PS** (18) and/or the clients $C_1...C_n$ (16) may also incorporate corresponding additional optional responses $RA_{11}...RA_{nm}$ (40) into the service and/or information responses $IR_1...IR_n$ (34), which may be obtained by accessing optional databases 41 and/or 42, shown in FIGS. 5A and 5B, which may be optionally resident within the server **PS** (18) and/or the clients $C_1...C_n$ (16), respectively.

- 25 The server **PS** (18) and/or the clients $C_1...C_n$ (16) may optionally store the responses $R_{11}...R_{nm}$ (32) communicated therefrom the servers $S_1...S_z$ (20), in accordance with the designation scheme corresponding to the server designations $S_{11}...S_{nm}$ (30) in the optional databases 41 and/or 42, optionally resident within the server **PS** (18) and/or the clients $C_1...C_n$ (16), respectively, which may be optionally retrieved from the optional databases 41
30 and/or 42, and/or optionally incorporated into the service and/or information responses $IR_1...IR_n$ (34), and accessed as the additional optional responses $RA_{11}...RA_{nm}$ (40).

- The server **PS** (18) and/or the clients $C_1...C_n$ (16) may optionally communicate with the optional servers $SO_1...SO_p$ (22), and obtain information from each of the optional servers $SO_1...SO_p$ (22), which may also be
35 stored in the optional databases 41 and/or 42, which may be optionally resident within the server **PS** (18) and/or the clients $C_1...C_n$ (16), respectively, and which may be optionally incorporated into the service and/or information responses $IR_1...IR_n$ (34), and accessed as the additional optional responses $RA_{11}...RA_{nm}$ (40).

Each of the users $U_1 \dots U_n$ (12) may optionally communicate corresponding additional optional requests $q_{11} \dots q_{np}$ (44) therethrough the corresponding user interfaces $l_1 \dots l_n$ (14) and the corresponding clients $C_1 \dots C_n$ (16) to the optional servers $SO_1 \dots SO_p$ (22), based upon information in the service and/or information responses $IR_1 \dots IR_n$ (34) and/or other information presented to and/or available and/or known to the users $U_1 \dots U_n$ (12) therethrough the corresponding user interfaces $l_1 \dots l_n$ (14). The optional servers $SO_1 \dots SO_p$ (22) reply to the clients $C_1 \dots C_n$ (16) with corresponding responses $r_{11} \dots r_{np}$ (46), which the clients $C_1 \dots C_n$ (16) communicate therethrough the corresponding user interfaces $l_1 \dots l_n$ (14) to the corresponding users $U_1 \dots U_n$ (12), as shown in FIG. 2 for typical ones of the requests $q_{11} \dots q_{np}$ (44) and the corresponding responses $r_{11} \dots r_{np}$ (46).

10 F. ADDITIONAL DETAILS

Now, in more detail, the clients $C_1 \dots C_n$ (16) and the servers $S_1 \dots S_z$ (20) reside on the network 24. The users $U_1 \dots U_n$ (12) and the corresponding clients $C_1 \dots C_n$ (16) communicate one with the other therethrough the corresponding user interfaces $l_1 \dots l_n$ (14). The user U_1 (12), thus, communicates with the client C_1 (16), one with the other, therethrough the user interface l_1 (14); the user U_2 (12), thus, communicates with the client C_2 (16), one with the other, therethrough the user interface l_2 (14); the user U_n (12), thus, communicates with the client C_n (16), one with the other, therethrough the user interface l_n (14); and so on. Any particular user, designated user U_n (12), thus, communicates with corresponding client C_n (16), one with the other, through corresponding user interface l_n (14), as best shown later in FIGS. 6-8. The user U_n (12) may be used to designate any one of the users $U_1 \dots U_n$ (12); the user interface l_n (14) may be used to designate any one of the user interfaces $l_1 \dots l_n$ (14); the client C_n (16) may be used to designate any one of the users clients $C_1 \dots C_n$ (16); and so on. The client-server multitasking system 10 may also have the server PS (18) and the optional servers $SO_1 \dots SO_p$ (22) residing on the network 24.

There may be n different or same the service and/or information requests $IQ_1 \dots IQ_n$ (28) present on the network 24 at any time. Each of the service and/or information requests $IQ_1 \dots IQ_n$ (28) may have one or more of the same and/or different requests $Q_{11} \dots Q_{nm}$ (29) to be made of one or more of the same and/or different ones of the servers $S_1 \dots S_z$ (20), which are called server designations $S_{11} \dots S_{nm}$ (30), in accordance with the designation scheme which designates the servers $S_1 \dots S_z$ (20) to be communicated with corresponding to the requests $Q_{11} \dots Q_{nm}$ (29) as the corresponding server designations $S_{11} \dots S_{nm}$ (30). The service and/or information request IQ_n (28) may be used to designate any particular one of the service and/or information requests $IQ_1 \dots IQ_n$ (28). Requests $Q_{n1} \dots Q_{nm}$ (29) may be used to designate the particular requests $Q_{11} \dots Q_{nm}$ (29) associated therewith and corresponding to the service and/or information request IQ_n (28).

Each of the requests $Q_{11} \dots Q_{1m}$ from the client C_1 (16) may each be different one from the other or the same; each of the requests $Q_{21} \dots Q_{2m}$ from the client C_2 (16) may each be different one from the other or the same; and each of the requests $Q_{n1} \dots Q_{nm}$ (29) from the client C_n (16) may each be different one from the other or the same, and so on. The requests $Q_{11} \dots Q_{1m}$ (29), the requests $Q_{21} \dots Q_{2m}$ (29), and the requests $Q_{n1} \dots Q_{nm}$ (29), thus, may each be different one from the other, or the same, and so on. The requests $Q_{11} \dots Q_{nm}$ (29) from the clients $C_1 \dots C_n$ (14), thus, may each be different, one from the other, or the same, and may be made of the same and/or different ones of

the servers $S_1 \dots S_z$ (20) at the same time and/or different times, in accordance with the corresponding server designations $S_{n1} \dots S_{nm}$ (30). There may be m different or same ones of the requests $Q_{n1} \dots Q_{nm}$ (29) from the client C_n (16) at any time, and $n \times m$ different and/or same ones of the requests $Q_{11} \dots Q_{nm}$ (29) of the same and/or different ones of the servers $S_1 \dots S_z$ (20) present on the network 24 at any time.

5

This designation format, in which the first alphanumeric subscript after the parameter of interest, for example, as in the parameters $Q_{n1} \dots Q_{nm}$ representing the requests $Q_{n1} \dots Q_{nm}$ (29), represents the particular parameters corresponding to the user U_n (12), and the second alphanumeric subscript after the parameter of interest represents the 1st, 2nd, 3rd, through the m th one of the particular parameters, will be used as a designation scheme throughout. In this particular instance, for example, there are then m distinctly the same and/or different ones of the requests $Q_{n1} \dots Q_{nm}$ (29) associated with the n th user U_n , which is designated as the user U_n (12). There are then the same and/or different m distinctly the same and/or different server designations $S_{n1} \dots S_{nm}$ (30) associated with the n th user U_n , which is designated as the user U_n (12). The same and/or different requests $Q_{n1} \dots Q_{nm}$ (29), then, may be made of the same and/or different ones of the servers $S_1 \dots S_z$ (20), in accordance with the designation scheme corresponding to the corresponding certain ones of the server designations $S_{n1} \dots S_{nm}$ (30), associated with and corresponding to the user U_n (12).

Each of the clients $C_1 \dots C_n$ (16) may optionally also function as servers. Certain ones of the clients $C_1 \dots C_n$ (16) may, therefore, function only as clients, while alternate ones of the clients $C_1 \dots C_n$ (16) may function as clients and as servers. Each of the user interfaces $I_1 \dots I_n$ (14) may be integral with the clients $C_1 \dots C_n$ (16) or separate from the clients $C_1 \dots C_n$ (16). Therefore, certain ones of the user interfaces $I_1 \dots I_n$ (14) may be integral with the clients $C_1 \dots C_n$ (16), while yet other ones of the user interfaces $I_1 \dots I_n$ (14) may be separate from the clients $C_1 \dots C_n$ (16).

The client-server multitasking system 10 of the present invention, the client-server multitasking process 99, and the multitasking process 104, the server PS (18) and/or the clients $C_1 \dots C_n$ (16) are capable of retrieving, parsing, processing, formatting, organizing, grouping, sorting, and consolidating services and/or information therefrom the same and/or different ones of the servers $S_1 \dots S_z$ (20), and/or the optional servers $SO_1 \dots SO_p$ (22), and/or the clients $C_1 \dots C_n$ (16), having the same and/or different structures, formats, organizations, groupings, and/or data structures, and incorporating the parsed, processed, formatted, organized, grouped, sorted, and consolidated services and/or information thereinto the user responses $UR_1 \dots UR_n$ (37) for delivery to the user interfaces $I_1 \dots I_n$ (14) and use by the users $U_1 \dots U_n$ (12).

Now, the user interfaces $I_1 \dots I_n$ (14) may each be different, one from the other, or the same, and may change characteristics over time. Each of the user interfaces $I_1 \dots I_n$ (14) may change characteristics as a function of time, information, and/or instructions, and/or other means, which may be derived by the users $U_1 \dots U_n$ (12) and/or the clients $C_1 \dots C_n$ (16) and/or the servers $S_1 \dots S_z$ (20), and/or the server PS (18), and/or the optional servers $SO_1 \dots SO_p$ (22), and/or derived within the user interfaces $I_1 \dots I_n$ (14). The user interface $I_1 \dots I_n$ (14) may change state.

The user interface $I_1 \dots I_n$ (14) may also change as a function of optional timers and/or timed instructions associated therewith the user interfaces $I_1 \dots I_n$ (14), and/or associated therewith the clients $C_1 \dots C_n$ (16) and/or associated therewith the servers $S_1 \dots S_z$ (20), and/or associated therewith the server PS (18), and/or associated therewith the optional servers $SO_1 \dots SO_p$ (22), and/or instructions from the user $U_1 \dots U_n$ (12). Changes in the user interface I_n (14) may appear continuous to the user U_n (12), spaced in time, staccato, or static depending upon the optional timers and/or the timed instructions. Other conditions may change the user interface $I_1 \dots I_n$ (14), as well.

The user interfaces $I_1 \dots I_n$ (14) may be updated continuously, intermittently, manually, randomly, semi-automatically, automatically, repetitively, non-repetitively, singly, plurally, multiplexed, and/or a combination thereof or other suitable manner.

The user interfaces $I_1 \dots I_n$ (14) may be visual, such as graphical user interfaces, aural, and/or tactile, a combination thereof, and/or other suitable means. The user interfaces $I_1 \dots I_n$ (14) may be integral with the clients $C_1 \dots C_n$ (16) or separate.

II. A PARTICULAR USER, USER INTERFACE, AND CLIENT ON THE NETWORK

A. OVERVIEW

FIGS. 6-8 show typical particular ones of the users U_n (12), the corresponding ones of the user interfaces U_n (12), the corresponding ones of the clients C_n (16), the server PS (18), the servers $S_1 \dots S_z$ (20) designated by the server designations $S_{n1} \dots S_{nm}$ (30) corresponding to the requests $Q_{n1} \dots Q_{nm}$ (29) associated with the corresponding ones of the users U_n (12), and the optional servers $SO_1 \dots SO_p$ (22) of the client-server multitasking system 10 of the present invention, which reside on the network 24. The user U_n (12) communicates with the corresponding client C_n (16) therethrough the corresponding user interface I_n (14).

The user U_n (12) enters the corresponding user input U_i (25) having one or more same and/or different user requests $qu_{n1} \dots qu_{nu}$ (26) thereinto the user interface I_n (14). The user requests $qu_{n1} \dots qu_{nu}$ (26) are communicated from the user interface I_n (14) to the client C_n (16) within the user service and/or information request iq_n (27), having the user requests $qu_{n1} \dots qu_{nu}$ (26) and other optional information.

The user interface I_n (14) communicates the user service and/or information request iq_n (27) therethrough to the client C_n (16), which optionally formats the corresponding user service and/or information request iq_n (27) into the corresponding service and/or information request IQ_n (28), as required. The service and/or information request IQ_n (28) may have one or more the same and/or different requests $Q_{n1} \dots Q_{nm}$ (29) to be made of the servers $S_1 \dots S_z$ (20) designated by the server designations $S_{n1} \dots S_{nm}$ (30) at the same time.

The client C_n (16) may communicate the corresponding service and/or information request IQ_n (28) to the server PS (18). The server PS (18) parses, processes and/or formats the service and/or information request IQ_n (28) received from the client C_n (16) into the certain requests $Q_{n1} \dots Q_{nm}$ (29), and communicates the certain requests

$Q_{n1} \dots Q_{nm}$ (29) to the corresponding certain ones of the servers $S_1 \dots S_z$ (20) designated by the server designations $S_{n1} \dots S_{nm}$ (30), as shown for typical ones of the certain requests $Q_{n1} \dots Q_{nm}$ (29) in FIG. 6.

The client C_n (16) may alternatively parse, process and/or format the user service and/or information request iq_n (27) into the alternate requests $Q_{n1} \dots Q_{nm}$ (29), and communicate the alternate requests $Q_{n1} \dots Q_{nm}$ (29) to the corresponding alternate ones of the servers $S_1 \dots S_z$ (20) designated by the server designations $S_{n1} \dots S_{nm}$ (30), as shown for typical alternate ones of the requests $Q_{n1} \dots Q_{nm}$ (29) in FIG. 7.

The client C_n (16) may alternatively communicate the corresponding other alternate one of the service and/or information request IQ_n (28) to the server PS (18), which parses, processes and/or formats the other alternate one of the service and/or information request IQ_n (28) into the other alternate ones of the requests $Q_{n1} \dots Q_{nm}$ (29), and communicates the other alternate ones of the requests $Q_{n1} \dots Q_{nm}$ (29) to the corresponding other alternate ones of the servers $S_{11} \dots S_{nm}$ (30), and additionally the client C_n (16) may also parse, process and/or format the user service and/or information request iq_n (27) into yet other alternate ones of the requests $Q_{n1} \dots Q_{nm}$ (29), and communicate the yet other alternate ones of the requests $Q_{n1} \dots Q_{nm}$ (29) to the corresponding yet other alternate ones of the servers $S_{n1} \dots S_{nm}$ (30), as shown for typical other alternate ones of the requests $Q_{n1} \dots Q_{nm}$ (29) and typical yet other alternate ones of the requests $Q_{n1} \dots Q_{nm}$ (29) in FIG. 8.

Each of the servers $S_1 \dots S_z$ (20) designated by the server designations $S_{n1} \dots S_{nm}$ (30) replies to the server PS (18) and/or the client C_n (16), in accordance with the designation scheme corresponding to the corresponding certain ones of the server designations $S_{11} \dots S_{nm}$ (30), accordingly, and communicates the corresponding responses $R_{n1} \dots R_{nm}$ (32), associated with the requests $Q_{n1} \dots Q_{nm}$ (29), to the server PS (18) and/or the client C_n (16), accordingly. The server PS (18) and/or the client C_n (16) parse, format, process, group, and organize the responses $R_{n1} \dots R_{nm}$ (32) into the corresponding service and/or information response IR_n (34) and/or the user service and/or information response ir_n (36) having the corresponding parsed, processed, formatted, grouped, and organized service and/or information group G_n (35) acceptable to the client C_n (16) and the user interface I_n (14). The server PS (18) communicates the service and/or information response IR_n (34) to the client C_n (16), as required.

The client C_n (16) formats the service and/or information responses $IR_1 \dots IR_n$ (34) into the corresponding user service and/or information response ir_n (36), as required, and communicates the user service and/or information responses ir_n (36) thereto the user interfaces I_n (14). The user interface I_n (14) incorporates the user service and/or information response ir_n (36) into the user response UR_n (37), which is communicated by the user interfaces I_n (14) thereto the user U_n (12).

The server PS (18) and/or the client C_n (16) may optionally also incorporate the optional additional corresponding responses $RA_{n1} \dots RA_{nm}$ (40) (shown later in FIGS. 11, 12, 15, and 16) into the service and/or information response IR_n (34), which may be obtained by accessing the optional databases 41 and/or 42, which may be optionally resident within the server PS (18) and/or the client C_n (16), respectively

The server **PS (18)** and/or the client **C_n (16)** communicate the service and/or information response **IR_n (34)** therethrough the user interface **I_n (14)** to the user **U_n (12)**.

The server **PS (18)** and/or the clients **C_n (16)** may optionally store the responses **R_{n1...R_{nm} (32)}** communicated from the servers **S_{1...S_z (20)}** designated by the server designations **S_{n1...S_{nm} (30)}** in the optional databases **41** and/or **42**, optionally resident within the server **PS (18)** and/or the client **C_n (16)**, respectively, which may be optionally retrieved from the optional databases **41** and/or **42**, and/or optionally incorporated into the service and/or information response **IR_n (34)**, and accessed as the additional optional responses **RA_{n1...RA_{nm} (40)}**.

10 The server **PS (18)** and/or the client **C_n (16)** may optionally communicate with the optional servers **SO_{1...SO_p (22)}**, and obtain information from each of the optional servers **SO_{1...SO_p (22)}**, which may also be stored in the optional databases **41** and/or **42**, which may be optionally resident within the server **PS (18)** and/or the client **C_n (16)**, respectively, and which may be optionally incorporated into the service and/or information response **IR_n (34)**, and accessed as the additional optional responses **RA_{n1...RA_{nm} (40)}**.

15

The user **U_n (12)** may optionally communicate the corresponding additional optional requests **q_{n1...q_{np} (44)}** therethrough the user interface **I_n (14)** and the client **C_n (16)** to the optional servers **SO_{1...SO_p (22)}**, based upon information in the service and/or information response **IR_n (34)** and/or other information presented to and/or available and/or known to the user **U_n (12)** therethrough the user interface **I_n (14)**. The optional servers **SO_{1...SO_p (22)}** reply to the client **C_n (16)** with the corresponding responses **r_{n1...r_{np} (46)}**, which the client **C_n (16)** communicates therethrough the user interface **I_n (14)** to the user **U_n (12)**, as shown in FIGS. 6-8 for typical ones of the requests **q_{n1...q_{np} (44)}** and the corresponding responses **r_{n1...r_{np} (46)}**.

20

B. DIAGRAMMATIC REGROUPING

25 Now, in more detail, FIG. 9 shows a schematic representation of ones of the users **U_{1...U_n (12)}**, the corresponding user interfaces **I_{1...I_n (14)}**, the corresponding clients **C_{1...C_n (16)}**, the server **PS (18)**, the servers **S_{1...S_z (20)}**, and the optional servers **SO_{1...SO_p (22)}** of the client-server multitasking system **10** of the present invention, constructed in accordance with the present invention, which reside on the network **24**, regrouped diagrammatically and alternatively named for illustrative purposes only, to illustrate and visualize possible typical communication paths. Other than FIG. 9, the nomenclature previously described and utilized will be used throughout.

30

Now, as shown in FIG. 9, for illustrative purposes only, ones of the clients **C_{1...C_n (16)}** communicating with the server **PS (18)**, as in FIG. 6, may optionally be designated clients **CA_{1...CA_w (16A)}**, and so on. Ones of the clients **C_{1...C_n (16)}** communicating with the servers **S_{1...S_z (20)}**, as in FIG. 7, may optionally be designated clients **CB_{1...CB_x (16B)}**, and so on. Ones of the clients **C_{1...C_n (16)}** communicating with the server **PS (18)** and with the servers **S_{1...S_z (20)}**, as in FIG 8, may optionally be designated clients **CC_{1...CC_y (16C)}**, and so on.

35

WO 01/63406

PCT/US01/05926

The users $U_1 \dots U_n$ (12) and the corresponding user interfaces $I_1 \dots I_n$ (14) corresponding to the clients $C_1 \dots C_n$ (16) may, likewise, optionally be designated in FIG. 9 only: correspondingly to the clients $CA_1 \dots CA_w$ (16A), as users $UA_1 \dots UA_w$ (12A) and user interfaces $IA_1 \dots IA_w$ (14A), respectively; correspondingly to the clients $CB_1 \dots CB_x$ (16B), as users $UB_1 \dots UB_x$ (12B) and user interfaces $IB_1 \dots IB_x$ (14B), respectively; and correspondingly to the

5 clients $CC_1 \dots CC_y$ (16C), as users $UC_1 \dots UC_y$ (12C) and $IC_1 \dots IC_y$ (14C), respectively.

The clients $C_1 \dots C_n$ (16) being accounted for, the total of the clients $CA_1 \dots CA_w$ (16A), $CB_1 \dots CB_x$ (16B), and $CC_1 \dots CC_y$ (16C) of FIG. 9 add up to n , where n may be any number greater or equal to one, such that the subscripts $w + x + y = n$.

10

III. A PARTICULAR SERVICE AND/OR INFORMATION REQUEST AND ASSOCIATED SERVICE AND/OR INFORMATION RESPONSE ON THE NETWORK

B. THE SERVER PS (18)

FIG. 10 shows a typical particular one of the service and/or information requests $IQ_1 \dots IQ_n$ (28), designated as the service and/or information request IQ_n (28), having queries $QQ_{n1} \dots QQ_{nm}$ (53), corresponding server addresses $AQ_{n1} \dots AQ_{nm}$ (54), and optional instructions $VJ_{n1} \dots VJ_{nk}$ (52). The server addresses $AQ_{n1} \dots AQ_{nm}$ (54) and the optional instructions $VJ_{n1} \dots VJ_{nk}$ (52) may be optional, and may depend upon the user interface I_n (14), and/or other information resident within the server PS (18).

FIG. 11 shows the particular service and/or information request IQ_n (28) parsed, processed, and/or formatted into current request group QA_{nc} (50), request groups $QA_{n1} \dots QA_{nz}$ (51), and optional instructions $VJ_{n1} \dots VJ_{nk}$ (52), and utilization of information therefrom to make the requests $Q_{n1} \dots Q_{nm}$ (29), obtain the responses $R_{n1} \dots R_{nm}$ (32), and incorporate information therefrom into the particular service and/or information response IR_n (34). The current request group QA_{nc} (50) may be any particular one the request groups $QA_{n1} \dots QA_{nz}$ (51), which may be selected by

25 the user U_n (12).

Upon receipt of the service and/or information requests $IQ_1 \dots IQ_n$ (28) at the server PS (18), communicated therefrom the corresponding clients $C_1 \dots C_n$ (16), the server PS (18) parses, processes, and/or formats each of the service and/or information requests $IQ_1 \dots IQ_n$ (28) into the corresponding current request groups $QA_{1c} \dots QA_{nc}$ (50) having corresponding queries $QQ_{11} \dots QQ_{nm}$ (53) and corresponding server addresses $AQ_{11} \dots AQ_{nm}$ (54) to open

30 connections with and make the requests $Q_{11} \dots Q_{nm}$ (29) thereof the servers $S_1 \dots S_z$ (20), in accordance with the designation scheme which designates the certain ones of the servers $S_1 \dots S_z$ (20) to be communicated with corresponding to the requests $Q_{11} \dots Q_{nm}$ (29) as the corresponding server designations $S_{11} \dots S_{nm}$ (30), shown for a particular one of the service and/or information requests IQ_n (28) in FIG. 11.

35

The server PS (18) also parses, processes, and/or formats each of the service and/or information requests $IQ_1 \dots IQ_n$ (28) into the corresponding request groups $QA_{11} \dots QA_{nz}$ (51) having corresponding other queries $QQ_{1a} \dots QQ_{nz}$

(55) and corresponding other server addresses $AQ_{1a} \dots AQ_{nz}$ (56), and the corresponding optional instructions $VJ_{111} \dots VJ_{nk}$ (52), also shown for a particular one of the service and/or information requests IQ_n (28) in FIG. 11.

5 The server **PS** (18) opens connections with and makes the requests $Q_{n1} \dots Q_{nm}$ (29) thereof the servers $S_1 \dots S_z$ (20), in accordance with the designation scheme which designates the certain ones of the servers $S_1 \dots S_z$ (20) to be communicated with corresponding to the requests $Q_{n1} \dots Q_{nm}$ (29) as the corresponding server designations $S_{11} \dots S_{nm}$ (30), shown for the particular one of the service and/or information requests IQ_n (28) corresponding to the corresponding queries $QQ_{n1} \dots QQ_{nm}$ (53) and the corresponding server addresses $AQ_{n1} \dots AQ_{nm}$ (54) therein the current request group QA_{nc} (50).

10

The servers $S_1 \dots S_z$ (20) corresponding to the server designations $S_{11} \dots S_{nm}$ (30), designated in accordance with the designation scheme which designates the certain ones of the servers $S_1 \dots S_z$ (20) to be communicated with corresponding to the requests $Q_{n1} \dots Q_{nm}$ (29) as the corresponding server designations $S_{11} \dots S_{nm}$ (30), respond to the requests $Q_{n1} \dots Q_{nm}$ (29) with the corresponding responses $R_{n1} \dots R_{nm}$ (32).

15

The server **PS** (18) parses, and/or processes, and/or formats, and/or groups, and/or organizes each of the responses $R_{n1} \dots R_{nm}$ (32) received from the servers $S_1 \dots S_z$ (20) corresponding to the server designations $S_{n1} \dots S_{nm}$ (30) into corresponding addressable response information groups $RG_{n1} \dots RG_{nm}$ (57).

20 The server **PS** (18) may also make additional optional requests $QP_{n1} \dots QP_{nm}$ (58) of the optional database 41, which may be optionally resident within the server **PS** (18), and which may reply with the corresponding additional optional responses $RA_{n1} \dots RA_{nm}$ (40). The server **PS** (18) parses, and/or processes, and/or formats, and/or groups, and/or organizes each of the additional optional responses $RA_{n1} \dots RA_{nm}$ (40) into corresponding response information groups $RC_{n1} \dots RC_{nm}$ (59).

25

Information from the current request group QA_{nc} (50) having the corresponding queries $QQ_{n1} \dots QQ_{nm}$ (53) and the corresponding server addresses $AQ_{n1} \dots AQ_{nm}$ (54) is formulated into a corresponding request pointer/address group QZ_n (60) having pointers/addresses $PG_{n1} \dots PG_{nz}$ (61) associated therewith.

30 Each of the pointers/addresses $PG_{n1} \dots PG_{nz}$ (61) are directed to point/address corresponding addressable query pointer/address groups $QG_{n1} \dots QG_{nz}$ (62) associated therewith, which aid in obtaining information and/or services therefrom certain ones of addressable response information groups $RG_{n1} \dots RG_{nm}$ (57) to be incorporated thereinto addressable query information groups $GI_{n1} \dots GI_{nz}$ (63).

35 Grouping and/or sorting criteria may be incorporated thereinto the optional instructions $VJ_{n1} \dots VJ_{nk}$ (52), which may be entered thereinto the user interface I_n (14) therethrough the user input UI_n (25) by the user U_n (12). Grouping and/or sorting criteria may additionally and/or alternatively be optionally resident within the server **PS** (18) and/or the client C_n (16).

The grouping and/or sorting criteria gives the user U_n (12) the ability to formulate the query information groups $GI_{n1} \dots GI_{nz}$ (63) and the way in which information and/or services from the addressable response information groups $RG_{n1} \dots RG_{nm}$ (57) is presented to the user U_n (12) therethrough the user interface I_n (14).

- 5 Each of the addressable query pointer/address groups $QG_{n1} \dots QG_{nz}$ (62) are associated therewith the corresponding ones of the addressable query information groups $GI_{n1} \dots GI_{nz}$ (63). The addressable query pointer/address group QG_{n1} (62) is, thus, associated therewith the addressable query information group GI_{n1} (63); the addressable query pointer/address group QG_{n2} (62) is, thus, associated therewith the addressable query information group GI_{n2} (63); the addressable query pointer/address group QG_{nz} (62) is, thus, associated therewith the addressable query
10 information group GI_{nz} (63), and so on.

Each of the addressable query pointer/address groups $QG_{n1} \dots QG_{nz}$ (62) is formulated based upon the grouping and/or sorting criteria, which may be incorporated therein the optional instructions $VJ_{n1} \dots VJ_{nk}$ (52), and/or which may additionally and/or alternatively optionally be resident within the server PS (18) and/or the client C_n (16),
15 and/or information within the current request group QA_{nc} (50).

Each of the addressable query pointer/address groups $QG_{n1} \dots QG_{nz}$ (62) has pointers/addresses $PP_{n11} \dots PP_{nmr}$ (64) directed to address/point information therein the addressable response information groups $RG_{n1} \dots RG_{nm}$ (57) based upon the grouping and/or sorting criteria, which may be incorporated therein the optional instructions $VJ_{n1} \dots VJ_{nk}$
20 (52), and/or which may additionally and/or alternatively optionally be resident within the server PS (18) and/or the client C_n (16), and/or the corresponding queries $QQ_{n1} \dots QQ_{nm}$ (53), and/or the corresponding server addresses $AQ_{n1} \dots AQ_{nm}$ (54) within the current request group QA_{nc} (50).

Information and/or services within each of the addressable response information groups $RG_{n1} \dots RG_{nm}$ (57) is
25 addressed therewith the pointers/addresses $PP_{n11} \dots PP_{nmr}$ (64) therefrom the query pointer/address groups $QG_{n1} \dots QG_{nz}$ (62), and information and/or services therefrom the addressable response information groups $RG_{n1} \dots RG_{nm}$ (57) is incorporated therein the addressable query information groups $GI_{n1} \dots GI_{nz}$ (63) corresponding to the pointers/addresses $PP_{n11} \dots PP_{nmr}$ (64), which are formulated by the addressable query pointer/address groups $QG_{n1} \dots QG_{nz}$ (62), in accordance with the grouping and/or sorting criteria.

30 The corresponding other queries $QQ_{na} \dots QQ_{nz}$ (55) and the corresponding other server addresses $AQ_{na} \dots AQ_{nz}$ (56) therein the corresponding request groups $QA_{n1} \dots QA_{nz}$ (51) may be used for other ones of the requests $Q_{n1} \dots Q_{nm}$ (29), and may be incorporated into the service and/or information response IR_n (34), as part of other information OI_n (65), for future use.

35 Each of the addressable query information groups $GI_{n1} \dots GI_{nz}$ (63) is incorporated therein the service and/or information group G_n (35). The service and/or information group G_n (35) and the other information OI_n (65) are incorporated therein the service and/or information response IR_n (34).

The optional instructions $VJ_{n1} \dots VJ_{nk}$ (52) may be used by the server PS (18) in making the requests $Q_{n1} \dots Q_{nm}$ (29) and/or the additional optional requests $QP_{n1} \dots QP_{nm}$ (58) of the optional database 41, and/or in processing, formatting, grouping, and organizing the responses $R_{n1} \dots R_{nm}$ (32) from the ones of the servers $S_1 \dots S_z$ (20) corresponding to the server designations $S_{n1} \dots S_{nm}$ (30), and/or the additional optional responses $RA_{n1} \dots RA_{nm}$ (40), into the corresponding service and/or information responses $IR_1 \dots IR_n$ (34), for grouping and/or sorting criteria instructions, and/or may be used for other purposes.

FIG. 12 is a schematic representation of the particular service and/or information request IQ_n (28) parsed, processed, and/or formatted into a current request group QA_n (50), request groups $QA_{n1} \dots QA_{nz}$ (51), and corresponding optional instructions $VJ_{n1} \dots VJ_{nk}$ (52), and utilization of information therefrom to make the requests $Q_{n1} \dots Q_{nm}$ (29), obtain the responses $R_{n1} \dots R_{nm}$ (32), and incorporate information therefrom into the particular service and/or information response IR_n (34), having simpler grouping/sorting that may be used additionally and/or alternatively to that of FIG. 11.

The user U_n (12) is typically given the option therethrough the optional instructions $VJ_{n1} \dots VJ_{nk}$ (52) as to the grouping and/or sorting criteria to be entered thereinto the user interface I_n (14) therethrough the user input UI_n (25) by the user U_n (12). The user U_n (12) is typically given the choice as to the grouping and/or sorting criteria to be used as in FIG. 11, and/or the grouping and/or sorting criteria of FIG. 12.

Information from the current request group QA_{nc} (50) having the corresponding queries $QQ_{n1} \dots QQ_{nm}$ (53) and the corresponding server addresses $AQ_{n1} \dots AQ_{nm}$ (54) is formulated into a corresponding request pointer/address group QY_n (68) having pointers/addresses $PF_{n11} \dots PF_{nmr}$ (69) associated therewith, as shown in FIG. 12.

Each of the pointers/addresses $PF_{n11} \dots PF_{nmr}$ (69) are directed to point/address the corresponding addressable response information groups $RG_{n1} \dots RG_{nm}$ (57), and aid in obtaining information and/or services therefrom the corresponding addressable response information groups $RG_{n1} \dots RG_{nm}$ (57) to be incorporated thereinto the addressable query information groups $GI_{n1} \dots GI_{nz}$ (63), as shown in FIG. 12.

The grouping and/or sorting criteria allow the user U_n (12) to direct the server PS (18) and/or the client C_n (16) to sort information and/or services therefrom the responses the responses $R_{n1} \dots R_{nm}$ (32) and/or the additional optional responses $RA_{n1} \dots RA_{nm}$ (40) therefrom the optional database 41, such as, for example, by category, query, group, page, order of importance, ascending and/or descending order, alphabetically and/or numerically, value, price, and/or other characteristics, and/or to combine and/or interleave the information and/or services therefrom the responses the responses $R_{n1} \dots R_{nm}$ (32) and/or the additional optional responses $RA_{n1} \dots RA_{nm}$ (40) one with the other, such as, for example, by order of relevance and/or other parameters.

FIG. 13 shows the particular service and/or information response IR_n (34) having a service and/or information group G_n (35), additional request links $SL_{n1} \dots SL_{nw}$ (71), optional order form 72, optional additional advertisements

and/or links **73**, optional hidden information **74**, and the optional service and/or information entry request form **IE_n** (**38**).

The service and/or information group **G_n** (**35**) has the query information groups **GI_{n1}...GI_{nz}** (**63**), optional database response groups **75**, and optional additional advertisements and/or links **76**.

The additional request links **SL_{n1}...SL_{nw}** (**71**) allow the user **U_n** (**12**) to make additional optional selections, based upon information and/or services previously requested by the user **U_n** (**12**). The additional request links **SL_{n1}...SL_{nw}** (**71**), which are optional, may typically have Current Group/Next Group/Previous Group/Group Number Links, Server Names in Each Group, Queries in Each Group, Current Page/Next Page/Previous Page/Page Number Links, Search Display/Link and/or Description Placement/Interleave/Separate, and Link Description Options/Summary/Minimize. Other additional ones of the additional requests links **SL_{n1}...SL_{nw}** (**71**) and/or combinations thereof may also be incorporated thereinto the service and/or information response **IR_n** (**34**).

The optional order form **72** allows direct placement and/or confirmation of orders and/or purchases therewith the servers **S₁...S_z** (**20**) and/or the optional servers **SO₁...SO_p** (**22**), which reside on the network **24**. The user **U_n** (**12**) may enter the order placement thereinto the user interface **I_n** (**14**) therethrough the user input **UI_n** (**25**), and receive order confirmation therethrough the user interface **I_n** (**14**). The client **C_n** (**16**) may communicate the order placement therefrom the user interface **I_n** (**14**) thereto the server **PS** (**18**), which may communicate the order placement thereto the servers **S₁...S_z** (**20**) and/or the optional servers **SO₁...SO_p** (**22**). The server **PS** (**18**) may alternatively and/or additionally communicate the order confirmation received therefrom the servers **S₁...S_z** (**20**) and/or the optional servers **SO₁...SO_p** (**22**) thereto the client **C_n** (**16**), which may communicate the order confirmation thereto the user interface **I_n** (**14**) for presentation to the user **U_n** (**12**). The order placement and/or the order confirmation may be stored within the server **PS** (**18**) and/or the client **C_n** (**16**). The order placement and/or the order confirmation is typically secure, and may be encrypted, and is typically communicated using secure communications means.

C. CERTAIN ONES OF THE CLIENTS

Certain ones of the clients **C₁...C_n** (**16**) may alternatively and/or additionally make the requests **Q₁₁...Q_{nm}** (**29**) thereof the servers **S₁...S_z** (**20**), in accordance with the designation scheme which designates the certain ones of the servers **S₁...S_z** (**20**) to be communicated with corresponding to the requests **Q₁₁...Q_{nm}** (**29**), and formulate the corresponding user service and/or information response **ir₁...ir_n** (**36**), as previously described.

FIG. 14 shows a typical particular one of the user service and/or information requests **iq₁...iq_n** (**27**), designated as the user service and/or information request **iq_n** (**27**), having the queries **QQ_{n1}...QQ_{nm}** (**53**), the corresponding server addresses **AQ_{n1}...AQ_{nm}** (**54**), and the optional instructions **VJ_{n1}...VJ_{nk}** (**52**). The server addresses **AQ_{n1}...AQ_{nm}** (**54**) and the optional instructions **VJ_{n1}...VJ_{nk}** (**52**) may be optional, and may depend upon the user interface **I_n** (**14**), and/or other information resident within the client **C_n** (**16**).

FIG. 15 shows the particular user service and/or information request iq_n (27) parsed, processed, and/or formatted into the current request group QA_{nc} (50), the request groups $QA_{n1}...QA_{nz}$ (51), and the corresponding optional instructions $VJ_{n1}...VJ_{nk}$ (52), and utilization of information therefrom to make the requests $Q_{n1}...Q_{nm}$ (29), obtain
 5 the responses $R_{n1}...R_{nm}$ (32), and incorporate information therefrom into the particular user service and/or information response ir_n (36);

The server PS (18) makes the requests $Q_{11}...Q_{nm}$ (29) thereof the servers $S_1...S_z$ (20), in accordance with the designation scheme which designates the certain ones of the servers $S_1...S_z$ (20) to be communicated with
 10 corresponding to the requests $Q_{11}...Q_{nm}$ (29) as the corresponding server designations $S_{11}...S_{nm}$ (30), as shown in FIG. 11, and certain ones of the clients $C_1...C_n$ (16) may additionally and/or alternatively make the requests $Q_{11}...Q_{nm}$ (29) thereof the servers $S_1...S_z$ (20), in accordance with the designation scheme which designates the certain ones of the servers $S_1...S_z$ (20) to be communicated with corresponding to the requests $Q_{11}...Q_{nm}$ (29) as the corresponding server designations $S_{11}...S_{nm}$ (30), as shown in FIG. 15.

15 The clients C_n (16) may parse, process, and/or format the user service and/or information requests iq_n (27) and/or organize and/or group information and/or services therefrom the addressable response information groups $RG_{n1}...RG_{nm}$ (57) thereinto the addressable query information groups $GI_{n1}...GI_{nz}$ (63) substantially the same as the server PS (18) parses, processes, and/or formats the service and/or information requests IQ_n (28) therefrom the
 20 addressable response information groups $RG_{n1}...RG_{nm}$ (57) thereinto the addressable query information groups $GI_{n1}...GI_{nz}$ (63), except that the client C_n (16) may organize the addressable query information groups $GI_{n1}...GI_{nz}$ (63) thereinto the user service and/or information response ir_n (36), as in FIG. 15, and the server PS (18) organizes the addressable query information groups $GI_{n1}...GI_{nz}$ (63) thereinto the corresponding service and/or information response IR_n (34), as in FIG. 11.

25 Upon receipt of the user service and/or information requests $iq_1...iq_n$ (27) at the corresponding clients $C_1...C_n$ (16), certain ones of the corresponding clients $C_1...C_n$ (16) may parse, process, and/or format the corresponding user service and/or information requests $iq_1...iq_n$ (27) into the corresponding current request groups $QA_{1c}...QA_{nc}$ (50) having the corresponding queries $QQ_{11}...QQ_{nm}$ (53) and the corresponding server addresses $AQ_{11}...AQ_{nm}$
 30 (54) to open connections with and make the requests $Q_{11}...Q_{nm}$ (29) thereof the servers $S_1...S_z$ (20), in accordance with the designation scheme which designates the certain ones of the servers $S_1...S_z$ (20) to be communicated with corresponding to the requests $Q_{11}...Q_{nm}$ (29) as the corresponding server designations $S_{11}...S_{nm}$ (30), shown for a particular one of the user service and/or information requests $iq_1...iq_n$ (27) in FIG. 15.

35 The corresponding clients $C_1...C_n$ (16) may also parse, process, and/or format the corresponding user service and/or information response $ir_1...ir_n$ (36) into the corresponding request groups $QA_{11}...QA_{nz}$ (51) having the corresponding other queries $QQ_{1a}...QQ_{nz}$ (55) and the corresponding other server addresses $AQ_{1a}...AQ_{nz}$ (56), and the corresponding optional instructions $VJ_{111}...VJ_{nk}$ (52), also shown for a particular one of the user service and/or information requests iq_n (27) in FIG. 15.

A particular one of the corresponding clients $C_1 \dots C_n$ (16), designated as the client C_n (16), may open connections with and make the requests $Q_{n1} \dots Q_{nm}$ (29) thereof the servers $S_1 \dots S_z$ (20), in accordance with the designation scheme which designates the certain ones of the servers $S_1 \dots S_z$ (20) to be communicated with corresponding to the requests $Q_{n1} \dots Q_{nm}$ (29) as the corresponding server designations $S_{11} \dots S_{nm}$ (30), shown for the particular one of the user service and/or information requests iq_n (27) corresponding to the corresponding queries $QQ_{n1} \dots QQ_{nm}$ (53) and the corresponding server addresses $AQ_{n1} \dots AQ_{nm}$ (54) therein the current request group QA_{nc} (50).

The servers $S_1 \dots S_z$ (20) corresponding to the server designations $S_{11} \dots S_{nm}$ (30), designated in accordance with the designation scheme which designates the certain ones of the servers $S_1 \dots S_z$ (20) to be communicated with corresponding to the requests $Q_{n1} \dots Q_{nm}$ (29) as the corresponding server designations $S_{11} \dots S_{nm}$ (30), respond to the requests $Q_{n1} \dots Q_{nm}$ (29) with the corresponding responses $R_{n1} \dots R_{nm}$ (32).

The client C_n (16) may parse, and/or process, and/or format, and/or group, and/or organize each of the responses $R_{n1} \dots R_{nm}$ (32) received from the servers $S_1 \dots S_z$ (20) corresponding to the server designations $S_{n1} \dots S_{nm}$ (30) into the corresponding addressable response information groups $RG_{n1} \dots RG_{nm}$ (57).

The client C_n (16) may also make additional optional requests $QP_{n1} \dots QP_{nm}$ (58) of the optional database 42, which may be optionally resident within the client C_n (16), and which may reply with the corresponding additional optional responses $RA_{n1} \dots RA_{nm}$ (40). The client C_n (16) may parse, and/or process, and/or format, and/or group, and/or organize each of the additional optional responses $RA_{n1} \dots RA_{nm}$ (40) into the corresponding response information groups $RC_{n1} \dots RC_{nm}$ (59).

Now again, for the client C_n (16), information from the current request group QA_{nc} (50) having the corresponding queries $QQ_{n1} \dots QQ_{nm}$ (53) and the corresponding server addresses $AQ_{n1} \dots AQ_{nm}$ (54) is formulated into the corresponding request pointer/address group QZ_n (60) having the pointers/addresses $PG_{n1} \dots PG_{nz}$ (61) associated therewith.

Now again, for the client C_n (16), each of the pointers/addresses $PG_{n1} \dots PG_{nz}$ (61) are directed to point/address the corresponding addressable query pointer/address groups $QG_{n1} \dots QG_{nz}$ (62) associated therewith, which aid in obtaining information and/or services therefrom certain ones of the addressable response information groups $RG_{n1} \dots RG_{nm}$ (57) to be incorporated therein into the addressable query information groups $GI_{n1} \dots GI_{nz}$ (63).

Yet again, for the client C_n (16), grouping and/or sorting criteria may be incorporated therein into the optional instructions $VJ_{n1} \dots VJ_{nk}$ (52), which may be entered therein into the user interface I_n (14) therethrough the user input UI_n (25) by the user U_n (12). Grouping and/or sorting criteria may additionally and/or alternatively optionally resident within the server PS (18) and/or the client C_n (16).

Now again, the grouping and/or sorting criteria gives the user U_n (12) the ability to formulate the query information groups $GI_{n1} \dots GI_{nz}$ (63) and the way in which information from the addressable response information groups $RG_{n1} \dots RG_{nm}$ (57) is presented to the user U_n (12) therethrough the user interface I_n (14).

- 5 Now again, for the client C_n (16), each of the addressable query pointer/address groups $QG_{n1} \dots QG_{nz}$ (62) are associated therewith the corresponding ones of the addressable query information groups $GI_{n1} \dots GI_{nz}$ (63). Each of the addressable query pointer/address groups $QG_{n1} \dots QG_{nz}$ (62) is formulated based upon the grouping and/or sorting criteria, which may be incorporated therein to the optional instructions $VJ_{n1} \dots VJ_{nk}$ (52), and/or which may additionally and/or alternatively optionally be resident within the server PS (18) and/or the client C_n (16), and/or
- 10 information within the current request group QA_{nc} (50).

- Now again, for the client C_n (16), each of the addressable query pointer/address groups $QG_{n1} \dots QG_{nz}$ (62) has pointers/addresses $PP_{n11} \dots PP_{nmr}$ (64) directed to address/point services and/or information therein the addressable response information groups $RG_{n1} \dots RG_{nm}$ (57) based upon the grouping and/or sorting criteria, which may be
- 15 incorporated therein to the optional instructions $VJ_{n1} \dots VJ_{nk}$ (52), and/or which may additionally and/or alternatively optionally be resident within the server PS (18) and/or the client C_n (16), and/or the corresponding queries $QQ_{n1} \dots QQ_{nm}$ (53), and/or the corresponding server addresses $AQ_{n1} \dots AQ_{nm}$ (54) within the current request group QA_{nc} (50).

- 20 Yet again, for the client C_n (16), the information and/or services therein each of the addressable response information groups $RG_{n1} \dots RG_{nm}$ (57) is addressed therewith the pointers/addresses $PP_{n11} \dots PP_{nmr}$ (64) therefrom the query pointer/address groups $QG_{n1} \dots QG_{nz}$ (62), and information and/or services therefrom the addressable response information groups $RG_{n1} \dots RG_{nm}$ (57) is incorporated therein to the addressable query information groups $GI_{n1} \dots GI_{nz}$ (63) corresponding to the pointers/addresses $PP_{n11} \dots PP_{nmr}$ (64), which are formulated by the
- 25 addressable query pointer/address groups $QG_{n1} \dots QG_{nz}$ (62), in accordance with the grouping and/or sorting criteria.

- Yet again, for the client C_n (16), the corresponding other queries $QQ_{na} \dots QQ_{nz}$ (55) and the corresponding other server addresses $AQ_{na} \dots AQ_{nz}$ (56) therein the corresponding request groups $QA_{n1} \dots QA_{nz}$ (51) may be used for
- 30 other ones of the requests $Q_{n1} \dots Q_{nm}$ (29), and may be incorporated into the user service and/or information response ir_n (36), as part of other information OI_n (65), for future use.

- Now again, for the client C_n (16), each of the addressable query information groups $GI_{n1} \dots GI_{nz}$ (63) is incorporated therein to the service and/or information group G_n (35). The service and/or information group G_n (35) and the other
- 35 information OI_n (65) are incorporated therein to the service and/or information response IR_n (34).

The optional instructions $VJ_{n1} \dots VJ_{nk}$ (52) may be used by the client C_n (16), in making the requests $Q_{n1} \dots Q_{nm}$ (29) and/or the additional optional requests $QP_{n1} \dots QP_{nm}$ (58) of the optional database 42, and/or in processing, formatting, grouping, and organizing the responses $R_{n1} \dots R_{nm}$ (32) from the ones of the servers $S_1 \dots S_z$ (20)

corresponding to the server designations $S_{n1} \dots S_{nm}$ (30), and/or the additional optional responses $RA_{n1} \dots RA_{nm}$ (40), into user service and/or information response ir_n (36), for grouping and/or sorting criteria instructions, and/or may be used for other purposes.

5 FIG. 16 is a schematic representation of the particular user service and/or information request iq_n (27) parsed, processed, and/or formatted into the current request group QA_{nc} (50), the request groups $QA_{n1} \dots QA_{nz}$ (51), and the corresponding optional instructions $VJ_{n1} \dots VJ_{nk}$ (52), and utilization of information therefrom to make the requests $Q_{n1} \dots Q_{nm}$ (29), obtain the responses $R_{n1} \dots R_{nm}$ (32), and incorporate information therefrom into the particular user service and/or information response ir_n (36), having simpler grouping/sorting that may be used additionally and/or
10 alternatively to that of FIG. 15.

The user U_n (12) is typically given the option therethrough the optional instructions $VJ_{n1} \dots VJ_{nk}$ (52) as to the grouping and/or sorting criteria to be entered thereinto the user interface I_n (14) therethrough the user input UI_n (25) by the user U_n (12). The user U_n (12) is typically given the choice as to the grouping and/or sorting criteria of FIG.
15 15, and/or the grouping and/or sorting criteria of FIG. 16.

Now again, the client C_n (16) may parse, process, and/or format the user service and/or information requests iq_n (27) and/or organize and/or group information and/or services therefrom the addressable response information groups $RG_{n1} \dots RG_{nm}$ (57) thereinto the addressable query information groups $GI_{n1} \dots GI_{nz}$ (63) substantially the
20 same as the server PS (18) parses, processes, and/or formats the service and/or information requests IQ_n (28) therefrom the addressable response information groups $RG_{n1} \dots RG_{nm}$ (57) thereinto the addressable query information groups $GI_{n1} \dots GI_{nz}$ (63), except that the client C_n (16) may organize the addressable query information groups $GI_{n1} \dots GI_{nz}$ (63) thereinto the user service and/or information response ir_n (36), as in FIG. 16, and the server PS (18) organizes the addressable query information groups $GI_{n1} \dots GI_{nz}$ (63) thereinto the corresponding service
25 and/or information response IR_n (34), as in FIG. 12.

Now again, for the client C_n (16), information from the current request group QA_{nc} (50) having the corresponding queries $QQ_{n1} \dots QQ_{nm}$ (53) and the corresponding server addresses $AQ_{n1} \dots AQ_{nm}$ (54) is formulated into the corresponding request pointer/address group QY_n (68) having the pointers/addresses $PF_{n11} \dots PF_{nmr}$ (69) associated
30 therewith, as shown in FIG. 16.

Now again, for the client C_n (16), each of the pointers/addresses $PF_{n11} \dots PF_{nmr}$ (69) are directed to point/address the corresponding addressable response information groups $RG_{n1} \dots RG_{nm}$ (57), and aid in obtaining information and/or services therefrom the corresponding addressable response information groups $RG_{n1} \dots RG_{nm}$ (57) to be
35 incorporated thereinto the addressable query information groups $GI_{n1} \dots GI_{nz}$ (63), as shown in FIG. 16.

Again, the grouping and/or sorting criteria allow the user U_n (12) to direct the server PS (18) and/or the client C_n (16) to sort information and/or services therefrom the responses the responses $R_{n1} \dots R_{nm}$ (32) and/or the additional optional responses $RA_{n1} \dots RA_{nm}$ (40) therefrom the optional database 41, such as, for example, by category, query,

group, page, order of importance, ascending and/or descending order, alphabetically and/or numerically, value, price, and/or other characteristics, and/or to combine and/or interleave the information and/or services therefrom the responses the responses $R_{n1}...R_{nm}$ (32) and/or the additional optional responses $RA_{n1}...RA_{nm}$ (40) one with the other, such as, for example, by order of relevance and/or other parameters.

5

FIG. 17 shows the particular user service and/or information response ir_n (36) having the service and/or information group G_n (35), the additional request links $SL_{n1}...SL_{nw}$ (71), the optional order form 72, the optional additional advertisements and/or links 73, the optional hidden information 74, and the optional service and/or information entry request form IE_n (38).

10

Now again, the service and/or information group G_n (35) has the query information groups $GI_{n1}...GI_{nz}$ (63), the optional database response groups 75, and the optional additional advertisements and/or links 76.

Yet again, the additional request links $SL_{n1}...SL_{nw}$ (71) allow the user U_n (12) to make additional optional selections, based upon information and/or services previously requested by the user U_n (12). The additional request links $SL_{n1}...SL_{nw}$ (71), which are optional, may typically have Current Group/Next Group/Previous Group/Group Number Links, Server Names in Each Group, Queries in Each Group, Current Page/Next Page/Previous Page/Page Number Links, Search Display/Link and/or Description Placement/Interleave/Separate, and Link Description Options/Summary/Minimize. Other additional ones of the additional request links $SL_{n1}...SL_{nw}$ (71) and/or combinations thereof may also be incorporated thereinto the user service and/or information response ir_n (36).

20

Now again, for the client C_n (16), the optional order form 72 allows direct placement and/or confirmation of orders and/or purchases therewith the servers $S_1...S_z$ (20) and/or the optional servers $SO_1...SO_p$ (22), which reside on the network 24. The user U_n (12) may enter the order placement thereinto the user interface I_n (14) therethrough the user input UI_n (25), and receive order confirmation therethrough the user interface I_n (14). The client C_n (16) may communicate the order placement therefrom the user interface I_n (14) thereto the servers $S_1...S_z$ (20) and/or the optional servers $SO_1...SO_p$ (22), and/or receive the order confirmation therefrom, and communicate the order confirmation therefrom the servers $S_1...S_z$ (20) and/or the optional servers $SO_1...SO_p$ (22) thereto the user interface I_n (14) for presentation to the user U_n (12). The order placement and/or the order confirmation may be stored within the server PS (18) and/or the client C_n (16). The order placement and/or the order confirmation is typically secure, and may be encrypted, and is typically communicated using secure communications means.

25

30

D. FORMULATING QUERY INFORMATION GROUPS

Each of the particular addressable response information groups $RG_{n1}...RG_{nm}$ (57), designated as the addressable response information group RG_{nm} (57), has optional addressable individual information groups $LG_{nm1}...LG_{nmr}$ (80), which may be addressed therewith the pointers/addresses $PP_{nm1}...PP_{nmr}$ (64), as shown in FIGS. 11, 15, 18A, 18B, and 18C.

35

Each of the addressable response information groups $\mathbf{RG}_{n1} \dots \mathbf{RG}_{nm}$ (57) and each of the optional addressable individual information groups $\mathbf{LG}_{n11} \dots \mathbf{LG}_{nmr}$ (80) therein each of the addressable response information groups $\mathbf{RG}_{n1} \dots \mathbf{RG}_{nm}$ (57) may be addressed therewith the pointers/addresses $\mathbf{PP}_{n11} \dots \mathbf{PP}_{nmr}$ (64).

5 Now again, the addressable response information group \mathbf{RG}_{nm} (57) has the optional addressable individual information groups $\mathbf{LG}_{nm1} \dots \mathbf{LG}_{nmr}$ (80), which may be addressed therewith the pointers/addresses $\mathbf{PP}_{nm1} \dots \mathbf{PP}_{nmr}$ (64). Each of the addressable individual information groups $\mathbf{LG}_{nm1} \dots \mathbf{LG}_{nmr}$ (80) therein the addressable response information group \mathbf{RG}_{nm} (57) may be pointed/addressed by the server \mathbf{PS} (18) and/or the client \mathbf{C}_n (16) to retrieve all and/or a portion and/or combinations thereof of specific ones of the addressable individual information groups
10 $\mathbf{LG}_{nm1} \dots \mathbf{LG}_{nmr}$ (80), therefrom the addressable response information group \mathbf{RG}_{nm} (57), and incorporate information and/or services therefrom the addressable individual information groups $\mathbf{LG}_{nm1} \dots \mathbf{LG}_{nmr}$ (80) thereinto certain ones of the addressable query information groups $\mathbf{GI}_{n1} \dots \mathbf{GI}_{nz}$ (63), in accordance with the grouping and/or sorting criteria addressing scheme.

15 The addressable response information group \mathbf{RG}_{nm} (57) having the optional addressable individual information groups $\mathbf{LG}_{nm1} \dots \mathbf{LG}_{nmr}$ (80) may have optional addressable pointer/address indices $\mathbf{IN}_{nm1} \dots \mathbf{IN}_{nmr}$ (81) correspondingly associated therewith the optional addressable individual information groups $\mathbf{LG}_{nm1} \dots \mathbf{LG}_{nmr}$ (80), which may be addressed/pointed therewith the pointers/addresses $\mathbf{PP}_{nm1} \dots \mathbf{PP}_{nmr}$ (64), and which may be pointed/addressed by the server \mathbf{PS} (18) and/or the client \mathbf{C}_n (16) to retrieve all and/or a portion and/or
20 combinations thereof of specific ones of the addressable individual information groups $\mathbf{LG}_{nm1} \dots \mathbf{LG}_{nmr}$ (80), and incorporate information and/or services therefrom the addressable individual information groups $\mathbf{LG}_{nm1} \dots \mathbf{LG}_{nmr}$ (80) thereinto the certain ones of the addressable query information groups $\mathbf{GI}_{n1} \dots \mathbf{GI}_{nz}$ (63), in accordance with the grouping and/or sorting criteria addressing scheme.

25 FIGS. 18A, 18B, and 18C show the addressable response information group \mathbf{RG}_{nm} (57) having the addressable individual information groups $\mathbf{LG}_{nm1} \dots \mathbf{LG}_{nmr}$ (80) showing the optional addressable pointer/address indices $\mathbf{IN}_{nm1} \dots \mathbf{IN}_{nmr}$ (81) correspondingly associated therewith the optional addressable individual information groups $\mathbf{LG}_{nm1} \dots \mathbf{LG}_{nmr}$ (80), which may be addressed/pointed therewith the pointer/addresses \mathbf{PP}_{nm1} (64), \mathbf{PP}_{nm2} (64), and \mathbf{PP}_{nmr} (64), respectively.

30 The optional addressable pointer/address index \mathbf{IN}_{nm1} (81) is correspondingly associated therewith the optional addressable individual information group \mathbf{LG}_{nm1} (80). The optional addressable pointer/address index \mathbf{IN}_{nm2} (81) is correspondingly associated therewith the optional addressable individual information group \mathbf{LG}_{nm2} (80), and so on. The optional addressable pointer/address index \mathbf{IN}_{nmr} (81) is, thus, correspondingly associated therewith the optional
35 addressable individual information group \mathbf{LG}_{nm1} (80).

The pointers/addresses $\mathbf{PG}_{n1} \dots \mathbf{PG}_{nz}$ (61) may be formulated as arrays and/or lists. The pointers/addresses $\mathbf{PP}_{nm1} \dots \mathbf{PP}_{nmr}$ (64) and/or the pointers/addresses $\mathbf{PF}_{nm1} \dots \mathbf{PF}_{nmr}$ (69) may be formulated as arrays and/or lists. The arrays may be multidimensional arrays, and the lists may be lists within lists.

The optional addressable individual information group \mathbf{LG}_{nmr} (80) is associated therewith and corresponds to a particular one of the addressable individual information groups $\mathbf{LG}_{nm1} \dots \mathbf{LG}_{nmr}$ (80) therein a particular one of the addressable response information groups $\mathbf{RG}_{n1} \dots \mathbf{RG}_{nm}$ (57), designated as the addressable response information group \mathbf{RG}_{nm} (57). The first subscript of the optional addressable individual information groups \mathbf{LG}_{nmr} (80) is associated therewith and corresponds to the particular service and/or information request \mathbf{IQ}_n (28) and/or the user service and/or information request \mathbf{iq}_n (27). The second subscript of the optional addressable individual information groups \mathbf{LG}_{nmr} (80) is associated therewith and corresponds to a particular one of "1" through "m" i.e., 1.....m, of the addressable response information group $\mathbf{RG}_{n1} \dots \mathbf{RG}_{nm}$ (57). The third subscript of the optional addressable individual information groups \mathbf{LG}_{nmr} (80) is associated therewith and corresponds to a particular one of "1" through "r" i.e., 1.....r, of the optional addressable individual information group $\mathbf{LG}_{nm1} \dots \mathbf{LG}_{nmr}$ (80) within the addressable response information group \mathbf{RG}_{nm} (57).

The subscripts of the optional addressable pointer/address indices $\mathbf{IN}_{nm1} \dots \mathbf{IN}_{nmr}$ (81) are correspondingly associated therewith the subscripts of the corresponding addressable individual information groups $\mathbf{LG}_{nm1} \dots \mathbf{LG}_{nmr}$ (80).

A number and variety of pointing/addressing schemes are possible, which may be used for a variety of grouping and sorting criteria schemes and addressing/pointing schemes.

For example, the pointers/addresses $\mathbf{PG}_{n1} \dots \mathbf{PG}_{nz}$ (61) of the request pointer/address group \mathbf{QZ}_n (60) may be pointed/addressed thereto certain ones of the addressable query pointer/address groups $\mathbf{QG}_{n1} \dots \mathbf{QG}_{nz}$ (62), in accordance with certain grouping and/or sorting criteria schemes and/or pointing/addressing schemes. The pointers/addresses $\mathbf{PP}_{n11} \dots \mathbf{PP}_{nmr}$ (64) of each of the pointed/addressed addressable query pointer/address groups $\mathbf{QG}_{n1} \dots \mathbf{QG}_{nz}$ (62) may be pointed thereto the pointer/address indices $\mathbf{IN}_{n11} \dots \mathbf{IN}_{nmr}$ (81) of the optional addressable individual information groups $\mathbf{LG}_{nm1} \dots \mathbf{LG}_{nmr}$, i.e., 1.....r, and the pointers/addresses $\mathbf{PP}_{n11} \dots \mathbf{PP}_{nmr}$ (64), i.e., 1.....m, corresponding to the addressable response information groups $\mathbf{RG}_{n1} \dots \mathbf{RG}_{nm}$ (57) formulated by the addressable query pointer/address groups $\mathbf{QG}_{n1} \dots \mathbf{QG}_{nz}$ (62) may be pointed thereto certain ones of the addressable response information groups $\mathbf{RG}_{n1} \dots \mathbf{RG}_{nm}$ (57), in accordance with certain grouping and/or sorting criteria schemes and/or addressing schemes. This subprocess may be repeated until the information and/or services from the optional addressable individual information groups $\mathbf{LG}_{nm1} \dots \mathbf{LG}_{nmr}$ from the addressable response information groups $\mathbf{RG}_{n1} \dots \mathbf{RG}_{nm}$ (57) is incorporated therewith the certain ones of the addressable query information groups $\mathbf{GI}_{n1} \dots \mathbf{GI}_{nz}$ (63), in accordance with the grouping and/or sorting criteria addressing scheme, as formulated by the addressable query pointer/address groups $\mathbf{QG}_{n1} \dots \mathbf{QG}_{nz}$ (62) and the request pointer/address group \mathbf{QZ}_n (60).

Alternatively and/or additionally, the pointers/addresses $\mathbf{PG}_{n1} \dots \mathbf{PG}_{nz}$ (61) of the request pointer/address group \mathbf{QZ}_n (60) may be incremented therethrough each of the addressable query pointer/address groups $\mathbf{QG}_{n1} \dots \mathbf{QG}_{nz}$ (62). The pointers/addresses $\mathbf{PP}_{n11} \dots \mathbf{PP}_{nmr}$ (64) of each of the pointed/addressed addressable query pointer/address groups $\mathbf{QG}_{n1} \dots \mathbf{QG}_{nz}$ (62) may be pointed to the pointer/address indices $\mathbf{IN}_{n11} \dots \mathbf{IN}_{nmr}$ (81) of the optional addressable individual information groups $\mathbf{LG}_{nm1} \dots \mathbf{LG}_{nmr}$, i.e., 1.....r, and incremented once, and then the

pointers/addresses $PP_{n11} \dots PP_{nmr}$ (64), i.e., 1.....m, corresponding to the addressable response information groups $RG_{n1} \dots RG_{nm}$ (57) formulated by the addressable query pointer/address groups $QG_{n1} \dots QG_{nz}$ (62) may be incremented therethrough each of the addressable response information groups $RG_{n1} \dots RG_{nm}$ (57). This subprocess may be repeated until the information and/or services from the optional addressable individual information groups

5 $LG_{nm1} \dots LG_{nmr}$ from the addressable response information groups $RG_{n1} \dots RG_{nm}$ (57) is incorporated therein to the certain ones of the addressable query information groups $GI_{n1} \dots GI_{nz}$ (63), in accordance with the grouping and/or sorting criteria addressing scheme, and as formulated by the addressable query pointer/address groups $QG_{n1} \dots QG_{nz}$ (62).

10 Alternatively and/or additionally, the pointers/addresses $PP_{n11} \dots PP_{nmr}$ (64), i.e., 1.....m, may be incremented, corresponding to the addressable response information groups $RG_{n1} \dots RG_{nm}$ (57) formulated by the addressable query pointer/address groups $QG_{n1} \dots QG_{nz}$ (62), and then the pointers/addresses $PP_{n11} \dots PP_{nmr}$ (64), i.e., 1.....r, pointing to the pointer/address indices $IN_{n11} \dots IN_{nmr}$ (81) of the optional addressable individual information groups $LG_{nm1} \dots LG_{nmr}$ may then be incremented. This subprocess may be repeated until the information and/or services

15 from the optional addressable individual information groups $LG_{nm1} \dots LG_{nmr}$ from the addressable response information groups $RG_{n1} \dots RG_{nm}$ (57) is incorporated therein to the certain ones of the addressable query information groups $GI_{n1} \dots GI_{nz}$ (63), in accordance with the grouping and/or sorting criteria addressing scheme, and as formulated by the addressable query pointer/address groups $QG_{n1} \dots QG_{nz}$ (62).

20 Alternatively and/or additionally, the pointers/addresses $PF_{nm1} \dots PF_{nmr}$ (69), i.e., 1.....m, may be incremented, corresponding to the addressable response information groups $RG_{n1} \dots RG_{nm}$ (57) formulated by the addressable query pointer/address groups $QG_{n1} \dots QG_{nz}$ (62), and then the pointers/addresses $PF_{nm1} \dots PF_{nmr}$ (69), i.e., 1.....r, pointing to the pointer/address indices $IN_{n11} \dots IN_{nmr}$ (81) of the optional addressable individual information groups $LG_{nm1} \dots LG_{nmr}$ may then be incremented. This subprocess may be repeated until the information and/or services

25 from the optional addressable individual information groups $LG_{nm1} \dots LG_{nmr}$ from the addressable response information groups $RG_{n1} \dots RG_{nm}$ (57) is incorporated therein to the certain ones of the addressable query information groups $GI_{n1} \dots GI_{nz}$ (63), in accordance with the grouping and/or sorting criteria addressing scheme, and as formulated by the addressable query pointer/address groups $QG_{n1} \dots QG_{nz}$ (62).

30 The typical sorting and/or grouping criteria and the addressing/pointing schemes mentioned immediately above, for example, may group certain ones of the queries $QQ_{n1} \dots QQ_{nm}$ (53) having the same and/or substantially the same values grouped therein a particular one of the query information groups $GI_{nz} \dots GI_{nz}$ (63), designated as the query information group GI_{nz} (63).

35 The grouping and/or sorting criteria and schemes and the addressing/pointing schemes mentioned herein are but only a small portion of a much larger variety of grouping and/or sorting criteria and schemes and addressing/pointing schemes and/or combinations thereof that the client-server multitasking system 10 of the present invention may use and is capable of. The above mentioned examples are included herein to illustrate but a few examples of the capabilities of the client-server multitasking system 10 of the present invention.

The addressable individual information groups $\mathbf{LG}_{nm1} \dots \mathbf{LG}_{nmr}$ (80) are typically parsed, and/or processed, and/or formatted for consistency of presentation and/or appearance one with the other, as the addressable individual information groups $\mathbf{LG}_{nm1} \dots \mathbf{LG}_{nmr}$ (80) are incorporated thereinto the addressable response information groups $\mathbf{RG}_{n1} \dots \mathbf{RG}_{nm}$ (57) therefrom the responses $\mathbf{R}_{n1} \dots \mathbf{R}_{nm}$ (32).

Alternatively and/or additionally the addressable individual information groups $\mathbf{LG}_{nm1} \dots \mathbf{LG}_{nmr}$ (80) may be incorporated thereinto the addressable response information groups $\mathbf{RG}_{n1} \dots \mathbf{RG}_{nm}$ (57) therefrom the responses $\mathbf{R}_{n1} \dots \mathbf{R}_{nm}$ (32) in an as-is condition and/or in raw form.

The optional addressable individual information groups $\mathbf{LG}_{nm1} \dots \mathbf{LG}_{nmr}$ (80) therein the addressable response information group \mathbf{RG}_{nm} (57), having information and/or services parsed and/or processed, and/or formatted, and/or grouped therefrom the response \mathbf{R}_{nm} (32), may be correspondingly associated therewith the locations of the information and/or services therein the response \mathbf{R}_{nm} (32).

Each of the addressable individual information groups $\mathbf{LG}_{nm1} \dots \mathbf{LG}_{nmr}$ (80) may have and/or be parsed, and/or processed, and/or formatted, and/or organized, and/or grouped into corresponding optional links $\mathbf{LD}_{nm1} \dots \mathbf{LD}_{nmr}$ (82), and/or corresponding optional descriptions $\mathbf{DD}_{nm1} \dots \mathbf{DD}_{nmr}$ (83), and/or corresponding optional prices/values $\mathbf{PD}_{nm1} \dots \mathbf{PD}_{nmr}$ (84), and/or corresponding optional images $\mathbf{ID}_{nm1} \dots \mathbf{ID}_{nmr}$ (85), as shown in FIG. 19.

The optional links $\mathbf{LD}_{nm1} \dots \mathbf{LD}_{nmr}$ (82), the corresponding optional descriptions $\mathbf{DD}_{nm1} \dots \mathbf{DD}_{nmr}$ (83), the corresponding optional prices/values $\mathbf{PD}_{nm1} \dots \mathbf{PD}_{nmr}$ (84), and the corresponding optional images $\mathbf{ID}_{nm1} \dots \mathbf{ID}_{nmr}$ (85), corresponding to the addressable individual information groups $\mathbf{LG}_{nm1} \dots \mathbf{LG}_{nmr}$ (80) are typically associated correspondingly one with the other.

The optional link \mathbf{LD}_{nm1} (82), the corresponding optional description \mathbf{DD}_{nm1} (83), the corresponding optional price/value \mathbf{PD}_{nm1} (84), and the corresponding optional image \mathbf{ID}_{nm1} (85), corresponding to the optional individual information group \mathbf{LG}_{nm1} (80) are typically associated correspondingly one with the other. The optional link \mathbf{LD}_{nm2} (82), the corresponding optional description \mathbf{DD}_{nm2} (83), the corresponding optional price/value \mathbf{PD}_{nm2} (84), and the corresponding optional image \mathbf{ID}_{nm2} (85), corresponding to the addressable individual information group \mathbf{LG}_{nm2} (80) are typically associated correspondingly one with the other, and so on. The optional link \mathbf{LD}_{nmr} (82), the corresponding optional description \mathbf{DD}_{nmr} (83), the corresponding optional price/value \mathbf{PD}_{nmr} (84), and the corresponding optional image \mathbf{ID}_{nmr} (85), corresponding to the addressable individual information group \mathbf{LG}_{nmr} (80) are, thus, typically associated correspondingly one with the other.

The addressable individual information groups $\mathbf{LG}_{nm1} \dots \mathbf{LG}_{nmr}$ (80), which may have the corresponding optional links $\mathbf{LD}_{nm1} \dots \mathbf{LD}_{nmr}$ (82), and/or the corresponding optional descriptions $\mathbf{DD}_{nm1} \dots \mathbf{DD}_{nmr}$ (83), and/or the corresponding optional prices/values $\mathbf{PD}_{nm1} \dots \mathbf{PD}_{nmr}$ (84), and/or the corresponding optional images $\mathbf{ID}_{nm1} \dots \mathbf{ID}_{nmr}$ (85) are appended therewith labels/identifiers, as shown in FIG. 20, and incorporated thereinto certain ones of the

addressable query information groups $\mathbf{GI}_{n1} \dots \mathbf{GI}_{nz}$ (63), depending upon the grouping and/or sorting criteria. FIG. 21 shows a particular one of the addressable query information groups $\mathbf{GI}_{n1} \dots \mathbf{GI}_{nz}$ (63), designated as the query information group \mathbf{GI}_{nz} (63).

5 Now again, the optional addressable individual information group \mathbf{LG}_{nmr} (80) is associated therewith and corresponds to a particular one of the addressable individual information groups $\mathbf{LG}_{nm1} \dots \mathbf{LG}_{nmr}$ (80) therein a particular one of the addressable response information groups $\mathbf{RG}_{n1} \dots \mathbf{RG}_{nm}$ (57), designated as the addressable response information group \mathbf{RG}_{nm} (57). The first subscript of the optional addressable individual information groups \mathbf{LG}_{nmr} (80) is associated therewith and corresponds to the particular service and/or information request \mathbf{IQ}_n (28) and/or the user service and/or information request \mathbf{iq}_n (27). The second subscript of the optional addressable individual information groups \mathbf{LG}_{nmr} (80) is associated therewith and corresponds to a particular one of "1" through "m" i.e., 1.....m, of the addressable response information group $\mathbf{RG}_{n1} \dots \mathbf{RG}_{nm}$ (57). The third subscript of the optional addressable individual information groups \mathbf{LG}_{nmr} (80) is associated therewith and corresponds to a particular one of "1" through "r", i.e., 1.....r, of the optional addressable individual information group $\mathbf{LG}_{nm1} \dots \mathbf{LG}_{nmr}$ (80) within the addressable response information group \mathbf{RG}_{nm} (57).

FIG. 20 shows a labelled individual information group \mathbf{LL}_{nzu} (86) associated therewith a particular one of the addressable query information groups $\mathbf{GI}_{n1} \dots \mathbf{GI}_{nz}$ (63), designated as the addressable query information group \mathbf{GI}_{nz} (63), having optional group identifier \mathbf{GL}_{nc} (87), optional query link identifier \mathbf{LN}_{ncu} (88), optional resource location identifier \mathbf{SU}_{nw} (89), optional server and/or query identifier \mathbf{SI}_{nm} (90), and/or optional server link identifier \mathbf{LX}_{nmr} (91) appended thereto the addressable individual information group \mathbf{LG}_{nmr} (80).

The first alphanumeric subscript of the labelled individual information group \mathbf{LL}_{nzu} (86) is associated therewith and corresponds to the service and/or information response \mathbf{IR}_n (34) and/or the user service and/or information response \mathbf{ir}_n (36). The second alphanumeric subscript of the labelled individual information group \mathbf{LL}_{nzu} (86) is associated therewith and corresponds to a particular one of "1" through "z", i.e., 1.....z, of the addressable query information groups $\mathbf{GI}_{n1} \dots \mathbf{GI}_{nz}$ (63), designated as the addressable query information group \mathbf{GI}_{nz} (63), which the labelled individual information group \mathbf{LL}_{nzu} (86) is incorporated therein. The third alphanumeric subscript of the labelled individual information group \mathbf{LL}_{nzu} (86) is associated therewith and corresponds to a particular one of "1" through "u", i.e., 1.....u, of labelled individual information groups $\mathbf{LL}_{nz1} \dots \mathbf{LL}_{nzu}$ (86) within the addressable query information group \mathbf{GI}_{nz} (63).

The optional group identifier \mathbf{GL}_{nc} (87) labels and/or identifies the current request group \mathbf{QA}_{nc} (50). The optional group identifier \mathbf{GL}_{nc} (87) is associated therewith and corresponds to the current request group \mathbf{QA}_{nc} (50), which may be any particular one the request groups $\mathbf{QA}_{n1} \dots \mathbf{QA}_{nz}$ (51) selected by the user \mathbf{U}_n (12). The first alphanumeric subscript of the optional group identifier \mathbf{GL}_{nc} (87) is associated therewith and corresponds to the service and/or information response \mathbf{IR}_n (34) and/or the user service and/or information response \mathbf{ir}_n (36). The second subscript of the optional group identifier \mathbf{GL}_{nc} (87) is associated therewith and corresponds to the particular one of the request groups $\mathbf{QA}_{n1} \dots \mathbf{QA}_{nz}$ (51) selected by the user \mathbf{U}_n (12) as the current request group \mathbf{QA}_{nc} (50).

The optional query link identifier LN_{ncu} (88) is also associated therewith and corresponds to the current request group QA_{nc} (50). The optional query link identifier LN_{ncu} (88) labels and/or identifies the labelled individual information group LL_{nzu} (86). The first alphanumeric subscript of the optional query link identifier LN_{ncu} (88) is associated therewith and corresponds to the service and/or information response IR_n (34) and/or the user service and/or information response ir_n (36). The second subscript of the optional query link identifier LN_{ncu} (88) is also associated therewith and corresponds to the particular one of the request groups $QA_{n1} \dots QA_{nz}$ (51) selected by the user U_n (12) as the current request group QA_{nc} (50). The third alphanumeric subscript of the optional query link identifier LN_{ncu} (88) is associated therewith and corresponds to a particular one of "1" through "u", i.e., 1.....u, of the labelled individual information groups $LL_{nz1} \dots LL_{nzu}$ (86) therein the addressable query information group GI_{nz} (63).

The optional resource location identifier SU_{nw} (89) labels and/or identifies resource locations of information and/or services associated therewith and corresponding to the optional addressable individual information group LG_{nmr} (80) therein the labelled individual information group LL_{nzu} (86). The optional resource location identifier SU_{nw} (89) indicates and is associated therewith and corresponds to resource locations of information and/or services associated therewith certain ones of the optional servers $SO_1 \dots SO_p$ (22) and/or certain ones of the servers $S_1 \dots S_z$ (20). The optional resource location identifier SU_{nw} (89) may be obtained from certain information therein the optional addressable individual information group LG_{nmr} (80). The first alphanumeric subscript of the optional resource location identifier SU_{nw} (89) is associated therewith and corresponds to the service and/or information response IR_n (34) and/or the user service and/or information response ir_n (36). The second alphanumeric subscript of the optional resource location identifier SU_{nw} (89) is associated therewith and corresponds to a particular one of "1" through "w", i.e., 1.....w, of the optional resource location identifiers $SU_{n1} \dots SU_{nw}$ (89) therein the labelled individual information group LL_{nzu} (86).

The optional server and/or query identifier SI_{nm} (90) labels and/or identifies the query QQ_{nm} (53) and/or the corresponding server address AQ_{nm} (54) associated therewith and corresponding to the optional addressable individual information group LG_{nmr} (80) therein the corresponding labelled individual information group LL_{nzu} (86) of the current request group QA_{nc} (50). The first alphanumeric subscript of the optional server and/or query identifier SI_{nm} (90) is associated therewith and corresponds to the service and/or information response IR_n (34) and/or the user service and/or information response ir_n (36). The second alphanumeric subscript of the optional server and/or query identifier SI_{nm} (90) is associated therewith and corresponds to a particular one of "1" through "m", i.e., 1.....m, of the optional server and/or query identifiers $SI_{n1} \dots SI_{nm}$ (90), which may be correspondingly associated therewith the corresponding ones of the queries $QQ_{n1} \dots QQ_{nm}$ (53) and/or the corresponding ones of the server addresses $AQ_{n1} \dots AQ_{nm}$ (54).

The optional server link identifier LX_{nmr} (91) labels and/or identifies the location of the optional addressable individual information group LG_{nmr} (80) therein the corresponding addressable response information groups RG_{nm} (57). The first alphanumeric subscript of the optional server link identifier LX_{nmr} (91) is associated therewith and

corresponds to the service and/or information response IR_n (34) and/or the user service and/or information response ir_n (36). The second alphanumeric subscript of the optional server link identifier LX_{nmr} (91) is associated therewith and corresponds to the addressable response information group RG_{nm} (57). The third alphanumeric subscript of the optional server link identifier LX_{nmr} (91) is associated therewith and corresponds to a particular one of "1" through "r", i.e., 1.....r, of the optional server link identifiers $LX_{nm1}...LX_{nmr}$ (91), which may be correspondingly associated therewith the locations of certain ones of the optional addressable individual information group $LG_{nm1}...LG_{nmr}$ (80) therein the addressable response information groups RG_{nm} (57). The certain ones of the optional addressable individual information groups $LG_{nm1}...LG_{nmr}$ (80) therein the addressable response information group RG_{nm} (57), having information and/or services parsed and/or processed, and/or formatted, and/or grouped therefrom the response R_{nm} (32), which are labelled and/or identified therewith the optional server link identifiers $LX_{nm1}...LX_{nmr}$ (91), are correspondingly associated therewith the locations of the information and/or services therein the response R_{nm} (32). The optional server link identifiers $LX_{nm1}...LX_{nmr}$ (91), thus, identify and/or label the location of services and/or information therein the response R_{nm} (32).

FIG. 21 shows the addressable query information group GI_{nz} (63) having the labelled individual information groups $LL_{nz1}...LL_{nzu}$ (86), optional database labelled individual information groups $RL_{nz1}...RL_{nzx}$ (92), optional query description QT_{nz} (93), optional server descriptions and/or links $ST_{nz1}...ST_{nzf}$ (94), and optional advertisements and/or links $LT_{nz1}...LT_{nzt}$ (95). The first and second subscripts of the optional database labelled individual information groups $RL_{nz1}...RL_{nzx}$ (92), the optional query description QT_{nz} (93), the optional server descriptions and/or links $ST_{nz1}...ST_{nzf}$ (94), and the optional advertisements and/or links $LT_{nz1}...LT_{nzt}$ (95) are associated therewith and correspond to the addressable query information group GI_{nz} (63). The third subscripts of the optional database labelled individual information groups $RL_{nz1}...RL_{nzx}$ (92), the optional server descriptions and/or links $ST_{nz1}...ST_{nzf}$ (94), and the optional advertisements and/or links $LT_{nz1}...LT_{nzt}$ (95) are associated therewith and correspond to ones of the optional database labelled individual information groups $RL_{nz1}...RL_{nzx}$ (92), the optional server descriptions and/or links $ST_{nz1}...ST_{nzf}$ (94), and the optional advertisements and/or links $LT_{nz1}...LT_{nzt}$ (95), respectively.

IV PROCESS

FIG. 22 shows steps of a client-server multitasking process 99 of the present invention. The client-server multitasking process 99 is shown for the client-server multitasking system 10 for a particular one of the users $U...U_n$ (12), designated as the user U_n (12), the corresponding particular one of the user interfaces $I...I_n$ (14), designated as the user interface I_n (14), the corresponding particular one of the clients $C...C_n$ (16), designated as the client C_n (16), the server PS (18), the servers $S_1...S_z$ (20), and the optional servers $SO_1...SO_p$ (22), which reside on the network 24.

35

The client-server multitasking process 99 starts at step 101. The user U_n (12) enters the user input UI_n (25) thereinto the user interface I_n (14) (step 102). The user input UI_n (25) is formulated thereinto the user service and/or information request iq_n (27) at the user interface I_n (14) and communicated thereto the client C_n (16) (step

103). The user service and/or information request iq_n (**27**) may be formulated thereinto the service and/or information request IQ_n (**28**) at the client C_n (**16**) and communicated thereto the server PS (**18**) (also step **103**).

The service and/or information response IR_n (**34**) and/or the user service and/or information response ir_n (**36**) are
 5 derived at the server PS (**18**) and/or the client C_n (**16**), respectively, at step **104**, which in itself is a process, and may hereinafter be referred to as the multitasking process **104**. The multitasking process **104** will be discussed in more detail later with reference to FIGS. 22-1A and 22-1B.

Now, continuing with FIG. 22, the user service and/or information response ir_n (**36**) may be derived at the client C_n
 10 (**16**) (step **104**) therefrom the service and/or information response IR_n (**34**), which may be communicated thereto the client C_n (**16**) therefrom the server PS (**18**) (also step **104**), and/or alternatively and/or additionally therefrom the responses $R_{n1}...R_{nm}$ (**32**), which may be communicated thereto the client C_n (**16**) (step **104**).

Now, the client C_n (**16**) may communicate the service and/or information request IQ_n (**28**) thereto the server PS
 15 (**18**) (step **103**). The service and/or information response IR_n (**34**) is then derived at the server PS (**18**) (step **104**) and communicated thereto the client C_n (**16**) (also step **104**). The user service and/or information response ir_n (**36**) may be derived therefrom the service and/or information response IR_n (**34**) (also step **104**).

Now, in more detail, if the service and/or information request IQ_n (**28**) is communicated thereto the server PS (**18**)
 20 (step **103**), then the server PS (**18**) makes the requests $Q_{n1}...Q_{nm}$ (**29**) and/or certain ones of the requests $Q_{n1}...Q_{nm}$ (**29**) thereof the servers $S_1...S_z$ (**20**), in accordance with the designation scheme which designates the certain ones of the servers $S_1...S_z$ (**20**) to be communicated with corresponding to the requests $Q_{n1}...Q_{nm}$ (**29**) as the corresponding server designations $S_{n1}...S_{nm}$ (**30**), utilizing information therefrom the service and/or information request IQ_n (**28**). The service and/or information response IR_n (**34**) is then derived at the server PS (**18**) (step **104**)
 25 therefrom the responses $R_{n1}...R_{nm}$ (**32**) received from the servers $S_1...S_z$ (**20**) corresponding to the server designations $S_{n1}...S_{nm}$ (**30**), and communicated thereto the client C_n (**16**). Now, again, the user service and/or information response ir_n (**36**) may be derived therefrom the service and/or information response IR_n (**34**) (also step **104**).

Now, also in more detail, alternatively and/or additionally, the client C_n (**16**) may make the requests $Q_{n1}...Q_{nm}$ (**29**)
 30 and/or certain other ones of the requests $Q_{n1}...Q_{nm}$ (**29**) thereof the servers $S_1...S_z$ (**20**), in accordance with the designation scheme which designates the certain ones of the servers $S_1...S_z$ (**20**) to be communicated with corresponding to the requests $Q_{n1}...Q_{nm}$ (**29**) as the corresponding server designations $S_{n1}...S_{nm}$ (**30**), utilizing information therefrom the user service and/or information request iq_n (**27**). Now, again, the user service and/or
 35 information response ir_n (**36**) may also be derived at the client C_n (**16**) (step **104**) therefrom the responses $R_{n1}...R_{nm}$ (**32**) communicated thereto the client C_n (**16**) (step **104**) and/or alternatively and/or additionally therefrom the service and/or information response IR_n (**34**) communicated thereto the client C_n (**16**) therefrom the server PS (**18**) (also step **104**).

The user service and/or information response ir_n (36), thus, may be derived therefrom the service and/or information response IR_n (34) communicated therefrom the server PS (18) thereto the client C_n (16) and/or alternatively and/or additionally therefrom the responses $R_{n1}...R_{nm}$ (32) communicated thereto the client C_n (16) (step 104).

- 5 The user service and/or information response ir_n (36) is communicated thereto the user interface I_n (14) (step 105) and incorporated thereinto the user response UR_n (37).

The user U_n (12) reviews the user response UR_n (37) and/or selects additional services and/or information (step 106). Step 106 will be discussed in more detail later with reference to FIG. 22-2. The process 99 ends at step 107.

- 10 The process 99 will be described in more detail with reference to FIGS. 1-70 of the drawings.

The service and/or information response IR_n (34) and/or the user service and/or information response ir_n (36) are derived at the server PS (18) and/or the client C_n (16), respectively, at step 104 in FIG. 22, and shown in more detail in FIGS. 22-1A and 22-1B.

15

FIG. 22-1A shows the multitasking process 104 of deriving the service and/or information response IR_n (34) and/or the user service and/or information response ir_n (36), with reference to FIGS. 11 and 15. FIG. 22-1B shows the multitasking process 104 of deriving the service and/or information response IR_n (34) and/or the user service and/or information response ir_n (36) having other grouping/sorting that may be used additionally and/or alternatively to that of FIGS. 11 and 15, as shown with reference to FIGS. 12 and 16. The multitasking process 104 will also be described in more detail with reference to FIGS. 1-70 of the drawings.

20

The server PS (18) and/or the client C_n (16) parse, process, and/or format the service and/or information request IQ_n (28) and/or the user service and/or information request iq_n (27) into the current request group QA_{nc} (50), the request groups $QA_{n1}...QA_{nz}$ (51), and the optional instructions $VJ_{n1}...VJ_{nk}$ (52) (step 104-1), as shown in FIGS. 22-1A and 22-1B.

25

Information therefrom the current request group QA_{nc} (50) and the optional instructions $VJ_{n1}...VJ_{nk}$ (52) may be used to make the requests $Q_{n1}...Q_{nm}$ (29), obtain the responses $R_{n1}...R_{nm}$ (32), and incorporate information therefrom into the service and/or information response IR_n (34) and/or the user service and/or information response ir_n (36), as shown in FIGS. 22-1A and 22-1B with reference to FIGS. 11, 12, 15, and 16. The current request group QA_{nc} (50) may be any particular one the request groups $QA_{n1}...QA_{nz}$ (51), which may be selected by the user U_n (12).

30

The current request group QA_{nc} (50) has the corresponding queries $QQ_{n1}...QQ_{nm}$ (53) and the corresponding server addresses $AQ_{n1}...AQ_{nm}$ (54) to open connections with and make the requests $Q_{n1}...Q_{nm}$ (29) thereof the servers $S_1...S_z$ (20), in accordance with the designation scheme which designates the certain ones of the servers $S_1...S_z$ (20) to be communicated with corresponding to the requests $Q_{n1}...Q_{nm}$ (29) as the corresponding server

35

designations $S_{n1} \dots S_{nm}$ (30), shown for the particular service and/or information request IQ_n (28) and/or the particular user service and/or information request iq_n (27).

5 The server **PS** (18) and/or the client C_n (16) open connections with and make the requests $Q_{n1} \dots Q_{nm}$ (29) having the corresponding queries $QQ_{n1} \dots QQ_{nm}$ (53) and the corresponding server addresses $AQ_{n1} \dots AQ_{nm}$ (54) therein the current request group QA_{nc} (50) thereof the servers $S_1 \dots S_z$ (20) (step 104-2) as shown in FIGS. 22-1A and 22-1B, in accordance with the designation scheme which designates the certain ones of the servers $S_1 \dots S_z$ (20) to be communicated with corresponding to the requests $Q_{n1} \dots Q_{nm}$ (29) as the corresponding server designations $S_{n1} \dots S_{nm}$ (30).

10

The servers $S_1 \dots S_z$ (20) corresponding to the server designations $S_{n1} \dots S_{nm}$ (30), designated in accordance with the designation scheme which designates the certain ones of the servers $S_1 \dots S_z$ (20) to be communicated with corresponding to the requests $Q_{n1} \dots Q_{nm}$ (29) as the corresponding server designations $S_{n1} \dots S_{nm}$ (30), respond to the requests $Q_{n1} \dots Q_{nm}$ (29) with the corresponding responses $R_{n1} \dots R_{nm}$ (32).

15

The server **PS** (18) and/or the client C_n (16) parse, and/or process, and/or format, and/or group, and/or organize each of the responses $R_{n1} \dots R_{nm}$ (32) received from the servers $S_1 \dots S_z$ (20) (step 104-3), as shown in FIGS. 22-1A and 22-1B with reference to FIGS. 36-38, corresponding to the server designations $S_{n1} \dots S_{nm}$ (30) thereinto the corresponding addressable response information groups $RG_{n1} \dots RG_{nm}$ (57).

20

The server **PS** (18) and/or the client C_n (16) may also make additional optional requests $QP_{n1} \dots QP_{nm}$ (58) of the optional databases 41 and/or 42 (also step 104-2 of FIGS. 22-1A and 22-1B), which may be optionally resident within the server **PS** (18) and/or the client C_n (16), and which may reply with the corresponding additional optional responses $RA_{n1} \dots RA_{nm}$ (40). The server **PS** (18) and/or the client C_n (16) parse, and/or process, and/or format, and/or group, and/or organize each of the additional optional responses $RA_{n1} \dots RA_{nm}$ (40) into the corresponding response information groups $RC_{n1} \dots RC_{nm}$ (59) (also step 104-3 of FIGS. 22-1A and 22-1B).

25

Now, step 104-3 of FIGS. 22-1A and 22-1B is shown in more detail in FIG. 22-1-1.

30 As discussed later, and shown in FIGS. 36-38, entity body RH_{nm} (353) of the response R_{nm} (32) has optional response individual information groups $LS_{nm1} \dots LS_{nmr}$ (360).

Each of the optional response individual information groups $LS_{n11} \dots LS_{nmr}$ (360) and/or portions thereof therefrom the entity bodies $RH_{n1} \dots RH_{nm}$ (353) of the responses $R_{n1} \dots R_{nm}$ (32) may be optionally compared one with the other, and duplicate ones of the optional response individual information groups $LS_{n11} \dots LS_{nmr}$ (360) may be optionally discarded (step 104-3-1), as shown in FIG. 22-1-1.

35

The remaining optional response individual information groups $LS_{n11} \dots LS_{nmr}$ (360) are parsed, and/or processed, and/or formatted, and/or organized, and/or grouped thereinto corresponding ones of the addressable individual

information groups $LG_{n11} \dots LG_{nmr}$ (80) as the addressable individual information groups $LG_{n11} \dots LG_{nmr}$ (80) are incorporated thereinto the addressable response information groups $RG_{n1} \dots RG_{nm}$ (57) therefrom the responses $R_{n1} \dots R_{nm}$ (32) (step 104-3-2), as shown in FIG. 22-1-1.

- 5 The addressable individual information groups $LG_{n11} \dots LG_{nmr}$ (80) are typically parsed, and/or processed, and/or formatted for consistency of presentation and/or appearance one with the other, as the addressable individual information groups $LG_{n11} \dots LG_{nmr}$ (80) are incorporated thereinto the addressable response information groups $RG_{n1} \dots RG_{nm}$ (57) therefrom the responses $R_{n1} \dots R_{nm}$ (32).
- 10 The server PS (18) and/or the client C_n (16) may formulate information from the current request group QA_{nc} (50) having the corresponding queries $QQ_{n1} \dots QQ_{nm}$ (53) and the corresponding server addresses $AQ_{n1} \dots AQ_{nm}$ (54) into the corresponding request pointer/address group QZ_n (60) having the pointers/addresses $PG_{n1} \dots PG_{nz}$ (61) associated therewith (step 104-4 of FIG. 22-1A with reference to FIGS. 11, 15, and 28). Alternatively and/or additionally, the server PS (18) and/or the client C_n (16) may formulate information from the current request group
- 15 QA_{nc} (50) having the corresponding queries $QQ_{n1} \dots QQ_{nm}$ (53) and the corresponding server addresses $AQ_{n1} \dots AQ_{nm}$ (54) into a corresponding request pointer/address group QY_n (68) having the pointers/addresses $PF_{n11} \dots PF_{nmr}$ (69) associated therewith (step 104-4 of FIG. 22-1B with reference to FIGS. 12 and 16).

- The server PS (18) and/or the client C_n (16) may formulate the addressable query pointer/address groups
- 20 $QG_{n1} \dots QG_{nz}$ (62) (step 104-5 of FIG. 22-1A with reference to FIGS. 11, 15, 28, 33, and typical ones of the addressable query pointer/address groups $QG_{n1} \dots QG_{nz}$ (62) in FIGS. 29 and 30), depending upon the grouping and/or sorting criteria used. Each of the pointers/addresses $PG_{n1} \dots PG_{nz}$ (61) may be directed to point/address the corresponding addressable query pointer/address groups $QG_{n1} \dots QG_{nz}$ (62) associated therewith, which aid in obtaining information and/or services therefrom certain ones of addressable response information groups
- 25 $RG_{n1} \dots RG_{nm}$ (57) to be incorporated thereinto addressable query information groups $GI_{n1} \dots GI_{nz}$ (63).

- Each of the addressable query pointer/address groups $QG_{n1} \dots QG_{nz}$ (62) has the pointers/addresses $PP_{n11} \dots PP_{nmr}$ (64) directed to address/point information therein the addressable response information groups $RG_{n1} \dots RG_{nm}$ (57) based upon the grouping and/or sorting criteria.

- 30 The grouping and/or sorting criteria may be incorporated thereinto the optional instructions $VJ_{n1} \dots VJ_{nk}$ (52), which may be entered thereinto the user interface I_n (14) therethrough the user input UI_n (25) by the user U_n (12). Grouping and/or sorting criteria may additionally and/or alternatively optionally resident within the server PS (18) and/or the client C_n (16).

- 35 The grouping and/or sorting criteria gives the user U_n (12) the ability to formulate the query information groups $GI_{n1} \dots GI_{nz}$ (63) and the way in which information and/or services from the addressable response information groups $RG_{n1} \dots RG_{nm}$ (57) is presented to the user U_n (12) therethrough the user interface I_n (14).

Information and/or services within each of the addressable response information groups $RG_{n1} \dots RG_{nm}$ (57) is addressed therewith the pointers/addresses $PP_{n11} \dots PP_{nmr}$ (64) therefrom the query pointer/address groups $QG_{n1} \dots QG_{nz}$ (62), and information and/or services therefrom the addressable response information groups $RG_{n1} \dots RG_{nm}$ (57) is incorporated thereinto the addressable query information groups $GI_{n1} \dots GI_{nz}$ (63) corresponding to the pointers/addresses $PP_{n11} \dots PP_{nmr}$ (64) (step 104-6 of FIG. 22-1A), which are formulated by the addressable query pointer/address groups $QG_{n1} \dots QG_{nz}$ (62), in accordance with the grouping and/or sorting criteria, as shown in FIG. 22-1A with reference to FIGS. 11, 15, 18A, 18B, 18C, 19 – 21, 28, 33, typical ones of the addressable query pointer/address groups $QG_{n1} \dots QG_{nz}$ (62) in FIGS. 29 and 30, and a typical one of the addressable query information groups $GI_{n1} \dots GI_{nz}$ (63), designated as the addressable query information group GI_{nz} (63), in FIG. 40.

Alternatively and/or additionally, each of the pointers/addresses $PF_{n11} \dots PF_{nmr}$ (69) may directed to point/address the corresponding addressable response information groups $RG_{n1} \dots RG_{nm}$ (57), and aid in obtaining information and/or services therefrom the corresponding addressable response information groups $RG_{n1} \dots RG_{nm}$ (57) to be incorporated thereinto the addressable query information groups $GI_{n1} \dots GI_{nz}$ (63) (step 104-6) as shown FIG. 22-1B with reference to FIGS. 12, 16, 18A, 18B, 18C, 19 – 21, and another typical one of the addressable query information groups $GI_{n1} \dots GI_{nz}$ (63), designated as the addressable query information group GI_{nz} (63), in FIG. 41.

Now, step 104-6 of FIG. 22-1A is shown in more detail in FIG. 22-1-2A with reference to FIGS. 11, 15, 18A, 18B, 18C, 19 – 21, 28, 33, typical ones of the addressable query pointer/address groups $QG_{n1} \dots QG_{nz}$ (62) in FIGS. 29 and 30, and a typical one of the addressable query information groups $GI_{n1} \dots GI_{nz}$ (63), designated as the addressable query information group GI_{nz} (63), in FIG. 40. Step 104-6 of FIG. 22-1B is shown in more detail in FIG. 22-1-2B with reference to FIGS. 12, 16, 18A, 18B, 18C, 19 – 21, and another typical one of the addressable query information groups $GI_{n1} \dots GI_{nz}$ (63), designated as the addressable query information group GI_{nz} (63), in FIG. 41.

The optional addressable individual information groups $LG_{n11} \dots LG_{nmr}$ (80) therein each of the addressable response information groups $RG_{n1} \dots RG_{nm}$ (57) may be addressed therewith the pointers/addresses $PP_{n11} \dots PP_{nmr}$ (64) (step 104-6-1) as shown FIG. 22-1-2A with reference to FIGS. 11 and 15 and FIG. 22-1A.

The optional addressable individual information groups $LG_{n11} \dots LG_{nmr}$ (80) therein each of the addressable response information groups $RG_{n1} \dots RG_{nm}$ (57) may alternatively and/or additionally be addressed therewith the pointers/addresses $PF_{n11} \dots PF_{nmr}$ (69) (step 104-6-1) as shown FIG. 22-1-2B with reference to FIGS. 12 and 16 and FIG. 22-1B.

The addressed optional addressable individual information groups $LG_{n11} \dots LG_{nmr}$ (80) an/or portions thereof may be optionally labelled with labels and/or identifiers and incorporated thereinto the labelled individual information groups $LL_{nz1} \dots LL_{nzu}$ (86) (step 104-6-2), as shown in FIGS. 22-1-2A and 22-1-2B.

The labelled individual information groups $LL_{nz1} \dots LL_{nzu}$ (86) may be incorporated thereinto certain ones of the addressable query information groups $GI_{n1} \dots GI_{nz}$ (63), depending upon the grouping and/or sorting criteria (step 104-6-3), as shown in FIGS. 22-1-2A and 22-1-2B.

- 5 The addressed optional addressable individual information groups $LG_{n11} \dots LG_{nmr}$ (80) an/or portions thereof are typically appended with the labels and/or identifiers, thus creating the labelled individual information groups $LL_{nz1} \dots LL_{nzu}$ (86), as each of the labelled individual information groups $LL_{nz1} \dots LL_{nzu}$ (86) are incorporated thereinto the certain ones of the addressable query information groups $GI_{n1} \dots GI_{nz}$ (63). The steps 104-6-2 and 104-6-3 are thus typically consolidated into a single step.

10

The addressable query information groups $GI_{n1} \dots GI_{nz}$ (63) may then be incorporated thereinto the service and/or information response IR_n (34) (step 104-7), as shown in FIGS. 22-1A and 22-1B with reference to FIG. 13, and/or the user service and/or information response ir_n (36) (also step 104-7), as also shown in FIGS. 22-1A and 22-1B but with reference to FIG. 17.

15

The user U_n (12) reviews the user response UR_n (37) the user interface I_n (14) and/or selects additional services and/or information at step 106 in FIG. 22, and shown in more detail in FIG. 22-2. The step 106 will also be described in more detail with reference to FIGS. 1-70 of the drawings.

- 20 The user U_n (12) selects additional services and/or information therethrough the user interface I_n (14) (step 106-1) or exits to the end of the process 99 at step 107. If the user U_n (12) selects additional services and/or information therethrough the user interface I_n (14) (step 106-1), the user U_n (12) may optionally enter one or more orders thereinto an order form and/or order forms thereat and therethrough the user interface I_n (14) (step 106-2). The order and/or orders may be, for example, for purchases, and/or instructions, and/or payment, and/or other
 25 information and/or services to be directed to and/or requested thereof third parties, and/or combinations thereof, of the optional servers $SO_1 \dots SO_p$ (22), and/or the servers $S_1 \dots S_z$ (20), and/or other ones of the clients $C_1 \dots C_n$ (16) therethrough the server PS (18) and/or the client C_n (16). The order and/or orders may, thus, be placed therethrough and thereby the server PS (18) and/or the client C_n (16), eliminating the need for the user U_n (12) to place separate ones of the orders with the third parties, the optional servers $SO_1 \dots SO_p$ (22), and/or the servers
 30 $S_1 \dots S_z$ (20) separately and/or individually.

- The server PS (18) and/or the client C_n (16) process the orders and/or communicate the orders to the third parties, the optional servers $SO_1 \dots SO_p$ (22), and/or the servers $S_1 \dots S_z$ (20), and/or other ones of the clients $C_1 \dots C_n$ (16) (step 106-3). The server PS (18) and/or the client C_n (16) confirm the order (step 106-4). The user U_n (12) may
 35 select additional services and/or information therethrough the user interface I_n (14) (step 106-1) or exit to the end of the process 99 at step 107.

If the user U_n (12) selects additional services and/or information therethrough the user interface I_n (14) (step 106-1), the user U_n (12) may alternatively and/or additionally optionally enter information and/or service requests of the

optional servers $SO_1 \dots SO_p$ (22), and/or the servers $S_1 \dots S_z$ (20) therethrough the user interface I_n (14) (step 106-5) and/or exit to the end of the process 99 at step 107.

If the user U_n (12) selects additional services and/or information therethrough the user interface I_n (14) (step 106-1), the user U_n (12) may alternatively and/or additionally optionally enter additional requests as the user input UI_n (25) thereat and therethrough the user interface I_n (14) (step 106-6) and enter the process 99 at step 102.

V. ADDITIONAL DETAILS

A. USER INPUT

10 The user input UI_n (25), which the user U_n (12) makes therethrough the user interface I_n (14), may have one or a plurality of the same and/or different ones of the queries $QQ_{n1} \dots QQ_{nm}$ (53) to be made by the server PS (18) and/or the client C_n (16) of the same and/or different ones of the servers $S_1 \dots S_z$ (20), in accordance with the designation scheme which designates the servers $S_1 \dots S_z$ (20) to be communicated with corresponding to the requests $Q_{n1} \dots Q_{nm}$ (29) as the corresponding server designations $S_{n1} \dots S_{nm}$ (30) at the corresponding server
15 addresses $AQ_{n1} \dots AQ_{nm}$ (54).

The server PS (18) and/or the client C_n (16) parse, process, format, sort, group, and/or organize each of the responses $R_{n1} \dots R_{nm}$ (32) to the corresponding requests $Q_{n1} \dots Q_{nm}$ (29), received therefrom the servers $S_1 \dots S_z$ (20) designated by the server designations $S_{n1} \dots S_{nm}$ (30), and/or each of the additional optional responses $RA_{n1} \dots RA_{nm}$
20 (40) therefrom the server PS (18) and/or the client C_n (16). The parsed, processed, formatted, sorted, grouped, and/or organized results therefrom the server PS (18) and/or the client C_n (16) are communicated thereto the user U_n (12) therethrough the user interface I_n (14) as the user response UR_n (37), which the user U_n (12) may review, interact therewith, and/or select additional services and/or information therefrom.

25 The user U_n (12) enters the user input UI_n (25) having one or more of the same and/or different user requests $qu_{n1} \dots qu_{nu}$ (26) thereinto user interface I_n (14), as shown in FIG. 3. The user requests $qu_{n1} \dots qu_{nu}$ (26) are communicated from the user interface I_n (14) to the client C_n (16) within the user service and/or information request iq_n (27), having the user requests $qu_{n1} \dots qu_{nu}$ (26) and other optional information.

30 The user U_n (12) may enter the user input UI_n (25) having one or more of the same and/or different user requests $qu_{n1} \dots qu_{nu}$ (26) thereinto the service and/or information entry request form IE_n (38) at the user interface I_n (14), or thereinto the user interface I_n (14) therethrough other suitable means.

The user interfaces $I_1 \dots I_n$ (14) have suitable input means and/or suitable presentation and/or display means, which
35 allow the corresponding users $U_1 \dots U_n$ (12) to communicate therewith the corresponding clients $C_1 \dots C_n$ (16). The user U_n (12) may enter the user input UI_n (25) thereinto the service and/or information entry request form IE_n (38) at the user interface I_n (14). The user input UI_n (25) may be entered as user input values thereinto fields or alternate request links of the service and/or information entry request form IE_n (38).

B. USER INTERFACE DETAILS

The client-server multitasking system **10** of the present invention may have any suitable user interface **I_n (14)** acceptable to and/or preferred by the user **U_n (12)**, and acceptable to the client **C_n (16)**. The user interface **I_n (14)** may be, for example, a graphical user interface, visual, aural, and/or tactile user interface, and/or combination thereof, or other suitable interface. The user interface **I_n (14)** may be integral with the client **C_n (16)** or separate therefrom.

The user interface **I_n (14)** may be hardware based, and/or computer based, and/or process based, and/or a combination thereof, and may be a graphical user interface, such as, for example, a browser and/or combinations thereof, varieties of which are commonly used on the internet.

The service and/or information entry request form **IE_n (38)** may be optionally available to the user **U_n (12)** at the user interface **I_n (14)**, or the user **U_n (12)** may optionally request the service and/or information entry request form **IE_n (38)** therethrough the user interface **I_n (14)**.

Now again, the user interfaces **I_{1...I_n (14)}** may each be different, one from the other, or the same, and may change characteristics over time. Each of the user interfaces **I_{1...I_n (14)}** may change characteristics as a function of time, information, and/or instructions, and/or other means, which may be derived by the users **U_{1...U_n (12)}** and/or the clients **C_{1...C_n (16)}** and/or the servers **S_{1...S_z (20)}**, and/or the server **PS (18)**, and/or the optional servers **SO_{1...SO_p (22)}**, and/or derived within the user interfaces **I_{1...I_n (14)}**. The user interface **I_{1...I_n (14)}** may change state.

The user interface **I_{1...I_n (14)}** may also change as a function of optional timers and/or timed instructions associated therewith the user interfaces **I_{1...I_n (14)}**, and/or associated therewith the clients **C_{1...C_n (16)}** and/or associated therewith the servers **S_{1...S_z (20)}**, and/or associated therewith the server **PS (18)**, and/or associated therewith the optional servers **SO_{1...SO_p (22)}**, and/or instructions from the user **U_{1...U_n (12)}**. Changes in the user interface **I_n (14)** may appear continuous to the user **U_n (12)**, spaced in time, staccato, or static depending upon the optional timers and/or the timed instructions. Other conditions may change the user interface **I_{1...I_n (14)}**, as well.

The user interfaces **I_{1...I_n (14)}** may be updated continuously, intermittently, manually, randomly, semi-automatically, automatically, repetitively, non-repetitively, singly, plurally, multiplexed, and/or a combination thereof or other suitable manner.

The user interfaces **I_{1...I_n (14)}** may be visual, such as graphical user interfaces, aural, and/or tactile, a combination thereof, and/or other suitable means. The user interfaces **I_{1...I_n (14)}** may be integral with the clients **C_{1...C_n (16)}** or separate therefrom.

The user interfaces $I_1 \dots I_n$ (14) may change in response to the user inputs $UI_1 \dots UI_n$ (25), the service and/or information entry request forms $IE_1 \dots IE_n$ (38) at the user interfaces $I_1 \dots I_n$ (14), completed service and/or information request forms IF_n , the user service and/or information requests $iq_1 \dots iq_n$ (27), optional execute request elements, accessing the alternate request links $QL_{11} \dots QL_{1a}$, accessing server request links $UL_{11} \dots UL_{1s}$, accessing the additional request links $SL_{11} \dots SL_{1w}$ (71), the service and/or information responses $IR_1 \dots IR_n$ (34), the service and/or information response forms $IS_1 \dots IS_n$ (39). Other conditions may change the user interface $I_1 \dots I_n$ (14), as well.

Portions of the user responses $UR_1 \dots UR_n$ (37) may be mapped into and/or onto different portions of the user interfaces $I_1 \dots I_n$ (14) to facilitate interaction with and the needs of each of the users $U_1 \dots U_n$ (12). Such mappings may be optionally customized by the users $U_1 \dots U_n$ (12).

C. SERVICE AND/OR INFORMATION REQUEST DETAILS

Each of the users $U_1 \dots U_n$ (12) communicate the corresponding user service and/or information requests $iq_1 \dots iq_n$ (27) therethrough the corresponding user interfaces $I_1 \dots I_n$ (14) to the corresponding clients $C_1 \dots C_n$ (16), which optionally format the corresponding user service and/or information requests $iq_1 \dots iq_n$ (27) into the corresponding service and/or information requests $IQ_1 \dots IQ_n$ (28), as required.

Now, again, the user U_n (12) may instruct the user interface I_n (14) to communicate the user service and/or information requests iq_n (27). The user service and/or information request iq_n (27) is communicated from the user interface I_n (14) to the client C_n (16), which acts upon the user service and/or information request iq_n (27) to derive the service and/or information request IQ_n (28) therefrom.

The service and/or information request IQ_n (28) has information and/or elements, which may be used by the server PS (18) to make the requests $Q_{n1} \dots Q_{nm}$ (29) of the servers $S_1 \dots S_z$ (20), in accordance with the designation scheme which designates the ones of the servers $S_1 \dots S_z$ (20) to be communicated with corresponding to the requests $Q_{11} \dots Q_{nm}$ (29) as the corresponding server designations $S_{11} \dots S_{nm}$ (30). The client C_n (16) may additionally and/or alternatively make the requests $Q_{n1} \dots Q_{nm}$ (29) of the servers $S_1 \dots S_z$ (20), using information and/or elements within the user service and/or information request iq_n (27).

Now, again, each of the users $U_1 \dots U_n$ (12) communicate the corresponding user service and/or information requests $iq_1 \dots iq_n$ (27) therethrough the corresponding user interfaces $I_1 \dots I_n$ (14) to the corresponding clients $C_1 \dots C_n$ (16), which optionally format the corresponding user service and/or information requests $iq_1 \dots iq_n$ (27) into the corresponding service and/or information requests $IQ_1 \dots IQ_n$ (28), as required.

The user service and/or information requests $iq_1 \dots iq_n$ (27) may be communicated as the elements, values, field names, optional instructions, and/or alternate requests entered thereinto the completed service and/or information

entry request form IF_n or other suitable means therefrom the corresponding user interfaces $I_1...I_n$ (14) to the corresponding clients $C_1...C_n$ (16).

The users $U_1...U_n$ (12) may, thus, communicate the corresponding user service and/or information requests $iq_1...iq_n$ (27) to the clients $C_1...C_n$ (16) therethrough the user interfaces $I_1...I_n$ (14), upon entering the corresponding user inputs $UI_1...UI_n$ (25) thereinto the corresponding service and/or information entry request forms $IE_1...IE_n$ (38) at the corresponding the user interfaces $I_1...I_n$ (14). The completed service and/or information entry request forms $IF_1...IF_n$ are derived therefrom the user inputs $UI_1...UI_n$ (25) having the corresponding user service and/or information requests $iq_1...iq_n$ (27), which may be entered as values or alternate requests thereinto the corresponding service and/or information entry request forms $IE_1...IE_n$ (38).

The user $U_1...U_n$ (12) may alternatively communicate the user service and/or information requests $iq_1...iq_n$ (27) by entering the alternate request links $QL_{11}...QL_{na}$ (203) or the server request links $UL_{11}...UL_{ns}$ (204) or the additional request links $SL_{11}...SL_{nw}$ (71) thereinto the service and/or information entry request form $IE_1...IE_n$ (38) or thereinto the completed service and/or information request form $IF_1...IF_n$ (230).

The server PS (18) and/or the C_n (16) may alternatively and/or additionally use information resident within the server PS (18) and/or the client C_n (16), such as default information, and/or information communicated therefrom the user U_n (12) therethrough the user interface I_n (14) to the client C_n (16) to make the requests $Q_{n1}...Q_{nm}$ (29) of the servers $S_1...S_z$ (20), in accordance with the designation scheme which designates the ones of the servers $S_1...S_z$ (20) to be communicated with corresponding to the requests $Q_{11}...Q_{nm}$ (29) as the corresponding server designations $S_{11}...S_{nm}$ (30).

FIG. 23 is a schematic representation showing queries $QQ_{n1}...QQ_{nm}$ (53) and corresponding server addresses $AQ_{n1}...AQ_{nm}$ (54).

D. OPTIONAL INSTRUCTIONS

Now, in yet more detail, the user inputs $UI_1...UI_n$ (25) may have one or more of the same and/or different optional instruction values $VV_{11}...VV_{nv}$. The optional instruction values $VV_{11}...VV_{nv}$ may typically have instructions, which may be used by the server PS (18) and/or the clients $C_1...C_n$ (16), such as, for example, as instructions on how to request, organize, present and/or display, and/or retrieve services and/or information from the servers $S_1...S_z$ (20) and/or other suitable instructions.

E. COMMUNICATING THE SERVICE AND/OR INFORMATION REQUESTS

Now, each of the users $U_1...U_n$ (12) communicate the corresponding user service and/or information requests $iq_1...iq_n$ (27) therethrough the corresponding user interfaces $I_1...I_n$ (14) to the corresponding clients $C_1...C_n$ (16), which optionally format the corresponding user service and/or information requests $iq_1...iq_n$ (27) into the corresponding service and/or information requests $IQ_1...IQ_n$ (28). The clients $C_1...C_n$ (16) communicate the

corresponding service and/or information requests $IQ_1...IQ_n$ (28) thereto the server **PS (18)** and/or use the corresponding user service and/or information requests $iq_1...iq_n$ (27) internally to formulate the requests $Q_{11}...Q_{nm}$ (29).

5 **F. PARSING, PROCESSING, AND/OR FORMATTING THE SERVICE AND/OR INFORMATION REQUESTS**

The server **PS (18)** and/or the clients $C_1...C_n$ (16) parse, process, and/or format the service and/or information requests $IQ_1...IQ_n$ (28) into the requests $Q_{11}...Q_{nm}$ (29), the optional instructions $VJ_{11}...VJ_{nk}$ (52), and information to open connections $OC_{11}...OC_{nm}$ (323).

- 10 Upon receipt of the service and/or information requests $IQ_1...IQ_n$ (28) at the server **PS (18)**, communicated therefrom the clients $C_1...C_n$ (16), the server **PS (18)** parses, processes, and/or formats each of the corresponding service and/or information requests $IQ_1...IQ_n$ (28) into the corresponding queries $QQ_{11}...QQ_{nm}$ (53), the corresponding server addresses $AQ_{11}...AQ_{nm}$ (54) to open connections $OC_{11}...OC_{nm}$ (323) with and make the requests $Q_{11}...Q_{nm}$ (29) thereof the servers $S_1...S_z$ (20), in accordance with the designation scheme which
- 15 designates the certain ones of the servers $S_1...S_z$ (20) to be communicated with corresponding to the requests $Q_{11}...Q_{nm}$ (29), and/or the optional instructions $VJ_{11}...VJ_{nk}$ (52) to be used by the server **PS (18)** in making the requests $Q_{11}...Q_{nm}$ (29) and/or in processing, formatting, grouping, and organizing the responses $R_{11}...R_{nm}$ (32) from the ones of the servers $S_1...S_z$ (20) corresponding to the server designations $S_{11}...S_{nm}$ (30), and/or the additional optional responses $RA_{11}...RA_{nm}$ (40), into the corresponding service and/or information responses
- 20 $IR_1...IR_n$ (34), as shown in FIG. 86.

- Alternatively and/or additionally, upon receipt of the user service and/or information requests $iq_1...iq_n$ (27) at the corresponding clients $C_1...C_n$ (16), the corresponding clients $C_1...C_n$ (16) may parse, process, and/or format each of the user service and/or information requests $iq_1...iq_n$ (27) into corresponding queries $QQ_{11}...QQ_{nm}$ (53),
- 25 corresponding server addresses $AQ_{11}...AQ_{nm}$ (54) to open connections $OC_{11}...OC_{nm}$ (323) with and make the requests $Q_{11}...Q_{nm}$ (29) thereof the servers $S_1...S_z$ (20), in accordance with the designation scheme which designates the certain ones of the servers $S_1...S_z$ (20) to be communicated with corresponding to the requests $Q_{11}...Q_{nm}$ (29), and/or the optional instructions $VJ_{11}...VJ_{nk}$ (52) to be used by the corresponding clients $C_1...C_n$ (16) in making the requests $Q_{11}...Q_{nm}$ (29) and/or in processing, formatting, grouping, and organizing the responses
- 30 $R_{11}...R_{nm}$ (32) from the ones of the servers $S_1...S_z$ (20) corresponding to the server designations $S_{11}...S_{nm}$ (30), and/or the additional optional responses $RA_{11}...RA_{nm}$ (40), into the corresponding user service and/or information responses $ir_1...ir_n$ (36).

- The server **PS (18)** parses, processes, and/or formats each of the service and/or information requests $IQ_1...IQ_n$ (28)
- 35 into queries, server addresses to make the queries of, query groups and/or server groups, and instructions to be used by the server **PS (18)**, typically when the server **PS (18)** makes the requests $Q_{11}...Q_{nm}$ (29) of the servers $S_1...S_z$ (20) corresponding to the server designations $S_{11}...S_{nm}$ (30) and/or the server **PS (18)** processes, formats, groups, and organizes the responses $R_{11}...R_{nm}$ (32) from the ones of the servers $S_1...S_z$ (20) corresponding to the server

designations $S_{11}...S_{nm}$ (30) at the server PS (18). Otherwise, the clients $C_1...C_n$ (16) may parse, process, and/or format each of the user service and/or information requests $iq_1...iq_n$ (27) into queries, server addresses to make the queries of, query groups and/or server groups, and instructions, typically when the clients $C_1...C_n$ (16) make the requests $Q_{11}...Q_{nm}$ (29) of the servers $S_1...S_z$ (20) corresponding to the server designations $S_{11}...S_{nm}$ (30) and/or the clients $C_1...C_n$ (16) process, format, group, and organize the responses $R_{11}...R_{nm}$ (32) from the ones of the servers $S_1...S_z$ (20) corresponding to the server designations $S_{11}...S_{nm}$ (30) at the corresponding clients $C_1...C_n$ (16). Choice as to whether the server PS (18) and/or the clients $C_1...C_n$ (16) makes the requests $Q_{11}...Q_{nm}$ (29) of the servers $S_1...S_z$ (20) corresponding to the server designations $S_{11}...S_{nm}$ (30) and/or process, format, group, and organize the responses $R_{11}...R_{nm}$ (32) are dependent on processing capabilities of the server PS (18) and/or the clients $C_1...C_n$ (16) and other factors.

Ones of the requests $Q_{11}...Q_{nm}$ (29) may require further formatting and/or processing by the server PS (18) and/or the corresponding clients $C_1...C_n$ (16), and/or other ones of the requests $Q_{11}...Q_{nm}$ (29) may already be formatted in accordance with requirements with respect to communications protocols, the service and/or information requests $IQ_1...IQ_n$ (28), the servers $S_1...S_z$ (20), and/or the optional servers $SO_1...SO_p$ (22), and/or the server PS (18), and/or other requirements of the network 24 of the client-server multitasking system 10. The server PS (18) and/or the clients $C_1...C_n$ (16) parse, process, and/or format the requests $Q_{11}...Q_{nm}$ (29), as required.

G. FORMULATING THE REQUESTS

Each of the optional instructions $VJ_{11}...VJ_{nk}$ (52) is typically parsed, and/or processed, and/or formatted, and/or grouped, and/or organized into particular ones of the optional instructions $VJ_{n1}...VJ_{nk}$ (52) for use by the server PS (18) and/or particular ones of the clients $C_1...C_n$ (16), a particular one of the clients $C_1...C_n$ (16) being designated as the client C_n (16).

The additional request links $SL_{n1}...SL_{nw}$ (71) allow the user U_n (12) to make additional optional selections, based upon information and/or services previously requested by the user U_n (12).

FIG. 24 is a schematic representation of queries $QQ_{n1}...QQ_{nm}$, corresponding server addresses $AQ_{n1}...AQ_{nm}$, and optional instructions $VJ_{nm1}...VJ_{nk}$ that may be parsed, processed, and/or formatted from the service and/or information request IQ_n and/or the user service and/or information request iq_n , shows a schematic representation of a typical one of the optional service and/or information entry request form IE_n , and is schematically representational of a typical user interface I_n ,

Typical ones of the optional instructions $VJ_{n1}...VJ_{nk}$ (52) and the additional request links $SL_{n1}...SL_{nw}$ (71) that may be parsed, processed, and/or formatted from the service and/or information request IQ_n (28) and/or the user service and/or information request iq_n (27) are shown in FIG. 24.

The requests $Q_{11}...Q_{nm}$ (29) may be made by the server **PS** (18) and/or the corresponding clients $C_1...C_n$ (16) of the associated corresponding ones of the servers $S_1...S_z$ (20), according to the designation scheme corresponding to the corresponding ones of the server designations $S_{11}...S_{nm}$ (30), in accordance with the optional instructions $VJ_{11}...VJ_{nk}$ (52) and/or default values for the optional instructions $VJ_{11}...VJ_{nk}$ (52) resident within the server **PS** (18) and/or the corresponding clients $C_1...C_n$ (16).

The service and/or information responses $IR_1...IR_n$ (34) and/or the corresponding user service and/or information responses $ir_1...ir_n$ (36) may be formulated by the server **PS** (18) and/or the corresponding clients $C_1...C_n$ (16), in accordance with the optional instructions $VJ_{11}...VJ_{nk}$ (52) and/or default values for the optional instructions $VJ_{11}...VJ_{nk}$ (52) resident within the server **PS** (18) and/or the corresponding clients $C_1...C_n$ (16).

The optional instructions $VJ_{n1}...VJ_{nk}$ (52) and the additional request links $SL_{11}...SL_{nw}$ (71) for a particular one of the service and/or information requests IQ_n (28) may typically have Searches per Group 326, and/or Group 327, and/or Page 328A and/or Page 328B, and/or Timeout per Search Engine 329, and/or URL's per Search Engine 330, and/or Search Engine Results 331A and/or Search Display 331B, and/or URL Details 332A and/or Description and/or List 332B, as shown in FIG. 24. Default values may additionally and/or alternatively be established or be resident for any and/or all of the optional instructions $VJ_{11}...VJ_{nk}$ (52) within the server **PS** (18) and/or the clients $C_1...C_n$ (16).

The Searches per Group 326 are typically considered to be the number of the queries $QQ_{n1}...QQ_{nm}$ (53) to make of the servers $S_1...S_z$ (20) thereof at the corresponding server addresses $AQ_{n1}...AQ_{nm}$ (54), in accordance with the designation scheme which designates the certain ones of the servers $S_1...S_z$ (20) to make the requests $Q_{n1}...Q_{nm}$ (29) thereof as the corresponding ones of the server designations $S_{n1}...S_{nm}$ (30).

The Group 327 is considered to be the group of the queries $QQ_{n1}...QQ_{nm}$ (53) to make of the servers $S_1...S_z$ (20) thereof at the corresponding server addresses $AQ_{n1}...AQ_{nm}$ (54), in accordance with the designation scheme which designates the certain ones of the servers $S_1...S_z$ (20) to make the requests $Q_{n1}...Q_{nm}$ (29) thereof as the corresponding ones of the server designations $S_{n1}...S_{nm}$ (30).

The Page 328A and the Page 328B have certain service and/or information location information, which may be incorporated into the requests $Q_{n1}...Q_{nm}$ (29) to be made of the associated corresponding ones of the servers $S_1...S_z$ (20) thereof, at the corresponding server addresses $AQ_{n1}...AQ_{nm}$ (54), in accordance with the designation scheme corresponding to the corresponding ones of the server designations $S_{n1}...S_{nm}$ (30).

The Timeout per Search Engine 329 is considered to be substantially the maximum time for the server **PS** (18) and/or the particular client C_n (16) making the requests $Q_{n1}...Q_{nm}$ (29) to wait for each of the responses $R_{n1}...R_{nm}$ (32) therefrom certain ones of the servers $S_1...S_z$ (20), in accordance with the designation scheme which designates the certain ones of the servers $S_1...S_z$ (20) to be communicated with corresponding to the requests $Q_{n1}...Q_{nm}$ (29) as the corresponding server designations $S_{n1}...S_{nm}$ (30).

The URL's per Search Engine **330**, is considered to be the number of links, and/or descriptions, and/or prices/values, and/or images to be returned to the user interface I_n (**14**) from each of the responses $R_{n1} \dots R_{nm}$ (**32**).

- 5 The Search Engine Results **331A** and the Search Display **331B** each designate presentation and/or display schemes to be presented at the user interface I_n (**14**). The URL Details **332A** and the Description and/or List **332B** each also designate presentation and/or display schemes to be presented at the user interface I_n (**14**).

FIG. 25 is a schematic representation of certain typical optional instructions $VJ_{nm1} \dots VJ_{nk}$ (**52**) and/or certain
 10 additional request links $SL_{n1} \dots SL_{nw}$ (**71**), referred to as the Search Engine Results **331A**, which are shown to be Interleave **331A-1**, Separate **331A-2**, Combine $\$[a-z]$ **331A-3**, Combine $\$[z-a]$ **331A-4**, Separate $\$[a-z]$ **331A-5**, Separate $\$[z-a]$ **331A-6**, which are instructions for parsing, processing, sorting, and/or formatting the service and/or information response IR_n (**34**).

15 FIG. 26 is a schematic representation of other certain typical optional instructions $VJ_{nm1} \dots VJ_{nk}$ (**52**) and/or other certain additional request links $SL_{n1} \dots SL_{nw}$ (**71**), referred to as the URL Details **332A**, which are other instructions for parsing, processing, sorting, and/or formatting the service and/or information response IR_n (**34**) in Summary **332A-1** or List **332A-2** formats.

20 FIG. 27 depicts certain typical additional request links $SL_{n1} \dots SL_{nw}$ (**71**), and also shows the Search Display **331B**, which are shown to be Interleave **331B-1**, Separate **331B-2**, Combine $\$[a-z]$ **331B-3**, Combine $\$[z-a]$ **331B-4**, Separate $\$[a-z]$ **331B-5**, Separate $\$[z-a]$ **331B-6**, which are instructions for parsing, processing, sorting, and/or formatting the service and/or information response IR_n (**34**) and the Description and/or List **332B**, which are other instructions for parsing, processing, sorting, and/or formatting the service and/or information response IR_n (**34**) in
 25 Summary or List formats.

The optional instructions $VJ_{n1} \dots VJ_{nk}$ (**52**) may also typically have Next Group **333** and Previous Group **334**, which are considered to be the next group and the previous group, respectively, to make the queries $QQ_{n1} \dots QQ_{nm}$ (**53**) thereof at the next and previous ones of the corresponding groups of the queries $QQ_{n1} \dots QQ_{nm}$ (**53**) to make of
 30 the servers $S_1 \dots S_z$ (**20**) thereof at the corresponding server addresses $AQ_{n1} \dots AQ_{nm}$ (**54**), in accordance with the designation scheme which designates the certain ones of the servers $S_1 \dots S_z$ (**20**) to make the requests $Q_{n1} \dots Q_{nm}$ (**29**) thereof as the corresponding ones of the server designations $S_{n1} \dots S_{nm}$ (**30**). Information about Current Group **337** having the queries $QQ_{n1} \dots QQ_{nm}$ (**53**) and the server addresses $AQ_{n1} \dots AQ_{nm}$ (**54**) is also shown. Current Page Number **338** is also indicated.

35 The optional instructions $VJ_{n1} \dots VJ_{nk}$ (**52**) for a particular one of the service and/or information requests IQ_n (**28**) may also typically have Next Page **335** and Previous Page **336**, each of which has certain different service and/or information location information, which may be incorporated into the requests $Q_{n1} \dots Q_{nm}$ (**29**) to be made of the

associated corresponding ones of the servers $S_1 \dots S_z$ (20), in accordance with the designation scheme corresponding to the corresponding ones of the server designations $S_{n1} \dots S_{nm}$ (30).

H. DETERMINING QUERIES AND SERVERS TO MAKE THE REQUESTS THEREOF

5 The server **PS** (18) and/or the clients $C_1 \dots C_n$ (16) evaluate the optional instructions $VJ_{11} \dots VJ_{nk}$ (52), determine the queries $QQ_{11} \dots QQ_{nm}$ (53) and the servers $S_1 \dots S_z$ (20) to make the requests $Q_{11} \dots Q_{nm}$ (29) thereof at the corresponding server addresses $AQ_{11} \dots AQ_{nm}$ (54), in accordance with the designation scheme which designates the certain ones of the servers $S_1 \dots S_z$ (20) to be communicated with as the server designations $S_{11} \dots S_{nm}$ (30), corresponding to the requests $Q_{11} \dots Q_{nm}$ (29), and group the queries $QQ_{11} \dots QQ_{nm}$ (53) and the corresponding
10 server addresses $AQ_{11} \dots AQ_{nm}$ (54) associated therewith.

FIG. 24 shows typical ones of the queries $QQ_{n1} \dots QQ_{nm}$ (53), the corresponding server addresses $AQ_{n1} \dots AQ_{nm}$ (54), and the optional instructions $VJ_{n1} \dots VJ_{nk}$ (52) that may be parsed, processed, grouped, sorted, and/or formatted from the service and/or information request IQ_n (28) and/or the user service and/or information request
15 iq_n (27).

The queries $QQ_{11} \dots QQ_{nm}$ (53) and the servers $S_1 \dots S_z$ (20) to make the requests $Q_{11} \dots Q_{nm}$ (29) thereof are typically based upon the values designated therein and parsed from the queries $QQ_{11} \dots QQ_{nm}$ (53) and the values designated therein and parsed from the corresponding server addresses $AQ_{11} \dots AQ_{nm}$ (54), in accordance with the
20 designation scheme which designates the certain ones of the servers $S_1 \dots S_z$ (20) to be communicated with as the server designations $S_{11} \dots S_{nm}$ (30), corresponding to the requests $Q_{11} \dots Q_{nm}$ (29), and the Searches per Group 326, the Group 327, the Page 328A and/or the Page 328B within the optional instructions $VJ_{11} \dots VJ_{nk}$ (52).

The server **PS** (18) and/or the clients $C_1 \dots C_n$ (16) evaluate the values therein the Group 327, the Searches per
25 Group 326, the queries $QQ_{11} \dots QQ_{nm}$ (53), the corresponding server addresses $AQ_{11} \dots AQ_{nm}$ (54), and determine the servers $S_1 \dots S_z$ (20) corresponding to the corresponding server addresses $AQ_{11} \dots AQ_{nm}$ (54) within the Group 327, in accordance with the designation scheme which designates the certain ones of the servers $S_1 \dots S_z$ (20) to be communicated with as the server designations $S_{11} \dots S_{nm}$ (30) to make the requests $Q_{11} \dots Q_{nm}$ (29) thereof, and the Page 328A and/or the Page 328B.

30

The Group 327 and the Searches per Group 326 are used to determine which of the servers $S_1 \dots S_z$ (20) to make the requests $Q_{11} \dots Q_{nm}$ (29) thereof.

The server **PS** (18) and/or the clients $C_1 \dots C_n$ (16) determine the size of the Group 327 from the Searches per
35 Group 326 and the Group 327, and the servers $S_1 \dots S_z$ (20) associated with the corresponding server addresses $AQ_{11} \dots AQ_{nm}$ (54) within the Group 327, in accordance with the designation scheme which designates the certain ones of the servers $S_1 \dots S_z$ (20) to be communicated with as the server designations $S_{11} \dots S_{nm}$ (30).

WO 01/63406

PCT/US01/05926

The Searches per Group **326** and the Group **327** are used to formulate the current request groups **QA_{1c}...QA_{nc}** (**50**) having the corresponding queries **QQ₁₁...QQ_{nm}** (**53**) and the corresponding server addresses **AQ₁₁...AQ_{nm}** (**54**) to open connections with and make the requests **Q₁₁...Q_{nm}** (**29**) thereof of the servers **S₁...S_z** (**20**), in accordance with the designation scheme which designates the certain ones of the servers **S₁...S_z** (**20**) to be communicated with
 5 corresponding to the requests **Q₁₁...Q_{nm}** (**29**) thereof as the server designations **S₁₁...S_{nm}** (**30**), corresponding to the requests **Q₁₁...Q_{nm}** (**29**), for corresponding ones of the service and/or information requests **IQ₁...IQ_n** (**28**) and/or the user service and/or information requests **iq₁...iq_n** (**27**).

The queries **QQ₁₁...QQ_{nm}** (**53**), the server addresses **AQ₁₁...AQ_{nm}** (**54**), and the Page **328A** and/or the Page **328B**
 10 provide the location of information and/or services to the server **PS** (**18**) and/or the clients **C₁...C_n** (**16**) within the Group **327**, in accordance with the Searches per Group **326**, to make the requests **Q₁₁...Q_{nm}** (**29**) thereof, in accordance with the designation scheme which designates the ones of the servers **S₁...S_z** (**20**) to make the requests **Q₁₁...Q_{nm}** (**29**) thereof as the server designations **S₁₁...S_{nm}** (**30**), corresponding to the requests **Q₁₁...Q_{nm}** (**29**).

15 The URL's per Search Engine **330** determine whether the server **PS** (**18**) and/or the clients **C₁...C_n** (**16**) communicate additional ones of the requests **Q₁₁...Q_{nm}** (**29**) of the servers **S₁...S_z** (**20**), depending upon the number of the links, and/or descriptions, and/or prices/values, and/or images requested by ones of the user **U₁...U_n** (**12**) to be returned to the user interfaces **I₁...I_n** (**14**), and the number of links, and/or descriptions, and/or prices/values, and/or images available within each of the corresponding ones of the responses **R₁₁...R_{nm}** (**32**). If
 20 insufficient ones of the links, and/or descriptions, and/or prices/values, and/or images are not available within the responses **R₁₁...R_{nm}** (**32**) to satisfy delivery of the number of the URL's per Search Engine **330** requested by certain ones the users **U₁...U_n** (**12**), the server **PS** (**18**) and/or the clients **C₁...C_n** (**16**) may yet make additional ones of the requests **Q₁₁...Q_{nm}** (**29**) of the servers **S₁...S_z** (**20**), in order deliver the number of the links, and/or descriptions, and/or prices/values, and/or images requested in the number of the URL's per Search Engine **330** to the user
 25 interfaces **I₁...I_n** (**14**) requested by certain ones of the user **U₁...U_n** (**12**).

If the optional instructions do not indicate which ones of the servers **S₁...S_z** (**20**) to make the requests **Q₁₁...Q_{nm}** (**29**) thereof, in accordance with the designation scheme which designates the certain ones of the servers **S₁...S_z** (**20**) to be communicated with as the server designations **S₁₁...S_{nm}** (**30**), corresponding to the requests **Q₁₁...Q_{nm}** (**29**), default values may be used. The default values may be resident within the server **PS** (**18**) and/or the clients
 30 **C₁...C_n** (**16**).

If all and/or a portion of the optional instructions **VJ₁₁...VJ_{nk}** (**52**) are absent and/or are not communicated thereto the server **PS** (**18**) and/or the clients **C₁...C_n** (**16**), default values may be used. The default values may be resident
 35 within the server **PS** (**18**) and/or the clients **C₁...C_n** (**16**).

I. GROUPING THE QUERIES AND SORTING/GROUPING CRITERIA

Upon receipt of the service and/or information requests $IQ_1...IQ_n$ (28) at the server **PS** (18), communicated therefrom the corresponding clients $C_1...C_n$ (16), the server **PS** (18) parses, processes, and/or formats each of the service and/or information requests $IQ_1...IQ_n$ (28) into the corresponding current request groups $QA_{1c}...QA_{nc}$ (50) having the corresponding queries $QQ_{11}...QQ_{nm}$ (53) and the corresponding server addresses $AQ_{11}...AQ_{nm}$ (54) to open connections with and make the requests $Q_{11}...Q_{nm}$ (29) thereof the servers $S_1...S_z$ (20), in accordance with the designation scheme which designates the certain ones of the servers $S_1...S_z$ (20) to be communicated with corresponding to the requests $Q_{11}...Q_{nm}$ (29) as the corresponding server designations $S_{11}...S_{nm}$ (30), shown for a particular one of the service and/or information requests IQ_n (28) in FIG. 11. The process 104 of deriving the service and/or information response IR_n (34) for the grouping and/or sorting criteria of FIG. 11 is shown in FIG. 22-1A.

The server **PS** (18) also parses, processes, and/or formats each of the service and/or information requests $IQ_1...IQ_n$ (28) into the corresponding request groups $QA_{11}...QA_{nz}$ (51) having the corresponding other queries $QQ_{1a}...QQ_{nz}$ (55) and the corresponding other server addresses $AQ_{1a}...AQ_{nz}$ (56), and the corresponding optional instructions $VJ_{11}...VJ_{nk}$ (52), also shown for a particular one of the service and/or information requests IQ_n (28) in FIG. 11.

Certain ones of the clients $C_1...C_n$ (16) may alternatively and/or additionally make the requests $Q_{11}...Q_{nm}$ (29) thereof the servers $S_1...S_z$ (20), in accordance with the designation scheme which designates the certain ones of the servers $S_1...S_z$ (20) to be communicated with corresponding to the requests $Q_{11}...Q_{nm}$ (29) as the corresponding server designations $S_{11}...S_{nm}$ (30), and formulate the corresponding user service and/or information response $ir_1...ir_n$ (36), as previously described, as shown in FIG. 15. The process 104 of deriving the user service and/or information response ir_n (36) for the grouping and/or sorting criteria of FIG. 11 is shown in FIG. 22-1A.

Upon receipt of the user service and/or information requests $iq_1...iq_n$ (27) at the corresponding clients $C_1...C_n$ (16), certain ones of the corresponding clients $C_1...C_n$ (16) may parse, process, and/or format the corresponding user service and/or information requests $iq_1...iq_n$ (27) into the corresponding current request groups $QA_{1c}...QA_{nc}$ (50) having the corresponding queries $QQ_{11}...QQ_{nm}$ (53) and the corresponding server addresses $AQ_{11}...AQ_{nm}$ (54) to open connections with and make the requests $Q_{11}...Q_{nm}$ (29) thereof the servers $S_1...S_z$ (20), in accordance with the designation scheme which designates the certain ones of the servers $S_1...S_z$ (20) to be communicated with corresponding to the requests $Q_{11}...Q_{nm}$ (29), shown for a particular one of the user service and/or information requests iq_n (27) in FIG. 15. The corresponding clients $C_1...C_n$ (16) may also parse, process, and/or format the corresponding user service and/or information response $ir_1...ir_n$ (36) into the corresponding request groups $QA_{11}...QA_{nz}$ (51) having the corresponding other queries $QQ_{1a}...QQ_{nz}$ (55) and the corresponding other server addresses $AQ_{1a}...AQ_{nz}$ (56), and the corresponding optional instructions $VJ_{11}...VJ_{nk}$ (52), also shown for a particular one of the user service and/or information requests iq_n (27) in FIG. 15.

The server **PS** (18) makes the requests $Q_{11}...Q_{nm}$ (29) thereof the servers $S_1...S_z$ (20), in accordance with the designation scheme which designates the certain ones of the servers $S_1...S_z$ (20) to be communicated with

corresponding to the requests $Q_{11} \dots Q_{nm}$ (29) as the corresponding server designations $S_{11} \dots S_{nm}$ (30), as shown in FIG. 11, and certain ones of the clients $C_1 \dots C_n$ (16) may additionally and/or alternatively make the requests $Q_{11} \dots Q_{nm}$ (29) thereof the servers $S_1 \dots S_z$ (20), in accordance with the designation scheme which designates the certain ones of the servers $S_1 \dots S_z$ (20) to be communicated with corresponding to the requests $Q_{11} \dots Q_{nm}$ (29) as the corresponding server designations $S_{11} \dots S_{nm}$ (30), as shown in FIG. 15.

The Searches per Group 326 and the Group 327 are used to formulate the current request group QA_{nc} (50) having the corresponding queries $QQ_{n1} \dots QQ_{nm}$ (53) and the corresponding server addresses $AQ_{n1} \dots AQ_{nm}$ (54) to open connections with and make the requests $Q_{n1} \dots Q_{nm}$ (29) thereof the servers $S_1 \dots S_z$ (20), in accordance with the designation scheme which designates the certain ones of the servers $S_1 \dots S_z$ (20) to be communicated with corresponding to the requests $Q_{n1} \dots Q_{nm}$ (29) thereof as the server designations $S_{11} \dots S_{nm}$ (30), corresponding to the requests $Q_{11} \dots Q_{nm}$ (29), for the service and/or information request IQ_n (28) and/or the user service and/or information request iq_n (27).

Information from the current request group QA_{nc} (50) having the corresponding queries $QQ_{n1} \dots QQ_{nm}$ (53) and the corresponding server addresses $AQ_{n1} \dots AQ_{nm}$ (54) is formulated into the corresponding request pointer/address group QZ_n (60) having the pointers/addresses $PG_{n1} \dots PG_{nz}$ (61) associated therewith, as shown in FIGS. 11 and 15.

Each of the pointers/addresses $PG_{n1} \dots PG_{nz}$ (61) are directed to point/address the corresponding addressable query pointer/address groups $QG_{n1} \dots QG_{nz}$ (62) associated therewith, which aid in obtaining services and/or information therefrom the certain ones of the addressable response information groups $RG_{n1} \dots RG_{nm}$ (57) to be incorporated thereinto the query information groups $GI_{n1} \dots GI_{nz}$ (63).

Ones of the addressable query information groups $GI_{n1} \dots GI_{nz}$ (63) may be associated therewith corresponding ones of the addressable query pointer/address groups $QG_{n1} \dots QG_{nz}$ (62).

Each of the addressable query pointer/address groups $QG_{n1} \dots QG_{nz}$ (62) associated with the service and/or information request IQ_n has the pointers/addresses $PP_{n11} \dots PP_{nmr}$ (64) directed to address/point services and/or information therein the addressable response information groups $RG_{n1} \dots RG_{nm}$ (57), based upon the grouping and/or sorting criteria.

Information and/or services therein the addressable response information groups $RG_{n1} \dots RG_{nm}$ (57) is addressed therewith the pointers/addresses $PP_{n11} \dots PP_{nmr}$ (64) therefrom the query pointer/address groups $QG_{n1} \dots QG_{nz}$ (62), and information and/or services therefrom the addressable response information groups $RG_{n1} \dots RG_{nm}$ (57) is incorporated thereinto the addressable query information groups $GI_{n1} \dots GI_{nz}$ (63) corresponding to the pointers/addresses $PP_{n11} \dots PP_{nmr}$ (64), which are formulated by the addressable query pointer/address groups $QG_{n1} \dots QG_{nz}$ (62), in accordance with the grouping and/or sorting criteria.

FIGS. 11 and 15 show the request pointer/address group QZ_n (60), the addressable query pointer/address groups $QG_{n1} \dots QG_{nz}$ (62), the pointers/addresses $PP_{n11} \dots PP_{nmr}$ (64), associated ones of the addressable response information groups $RG_{n1} \dots RG_{nm}$ (57), and the query information group GI_{nz} (63) associated therewith the query pointer/address group QG_{nz} (62). FIGS. 11 and 15 show the r th pointers/addresses $PP_{n1r} \dots PP_{nmr}$ (64), which point to the r th optional addressable pointer/address indices $IN_{nmr} \dots IN_{nmr}$ (81) of the corresponding r th individual information groups $LG_{n1r} \dots LG_{nmr}$ (80) of the addressable response information groups $RG_{n1} \dots RG_{nm}$ (57) associated therewith the query pointer/address group QG_{nz} (62) and the associated query information group GI_{nz} (63).

10 FIG. 28 shows the request pointer/address group QZ_n (60), a particular one of the addressable query pointer/address groups $QG_{n1} \dots QG_{nz}$ (62), designated as the query pointer/address group QG_{nz} (62), the pointers/addresses $PP_{n11} \dots PP_{nmr}$ (64), associated ones of the addressable response information groups $RG_{n1} \dots RG_{nm}$ (57), and the query information group GI_{nz} (63) associated therewith the query pointer/address group QG_{nz} (62).

15 The addressable query pointer/address groups $QG_{n1} \dots QG_{nz}$ (62) each have corresponding ones of query information groups $GI_{n1} \dots GI_{nz}$ (63) associated therewith. Each of the query information groups $GI_{n1} \dots GI_{nz}$ (63) have information and/or services therein, which are derived therefrom information and/or services obtained from the certain ones of the addressable response information groups $RG_{n1} \dots RG_{nm}$ (57), which are addressed to provide such information therewith the aid of the corresponding pointers/addresses $PP_{n11} \dots PP_{nmr}$ (64). Each of the pointers/addresses $PP_{n11} \dots PP_{nmr}$ (64) are directed to point/address information and/or services therein the corresponding response information groups $RG_{n1} \dots RG_{nm}$ (57) associated therewith, which the information and/or services incorporated into the ones of the query information groups $GI_{n1} \dots GI_{nz}$ (63) associated therewith the corresponding addressable query pointer/address groups $QG_{n1} \dots QG_{nz}$ (62) is obtained therefrom.

25 The addressable query pointer/address groups $QG_{n1} \dots QG_{nz}$ (62) may be used to aid in formulating the query information groups $GI_{n1} \dots GI_{nz}$ (63), having information obtained the addressable response information groups RG_{nm} (57), resulting from certain ones of the queries $QQ_{n1} \dots QQ_{nm}$ (53) grouped one with the other and/or the associated ones of the corresponding server addresses $AQ_{n1} \dots AQ_{nm}$ (54). The query information groups $GI_{n1} \dots GI_{nz}$ (63) may be presented thereto the user U_n (12) therethrough the user interface I_n (14). The addressable query pointer/address groups $QG_{n1} \dots QG_{nz}$ (62) may be derived therefrom query criteria in the optional instructions $VJ_{11} \dots VJ_{nk}$ (52) and/or using default criteria resident within the server PS (18) and/or the client C_n (16).

35 Query grouping criteria giving the user U_n (12) the ability to formulate the addressable query pointer/address groups $QG_{n1} \dots QG_{nz}$ (62) may be incorporated thereinto the optional instructions $VJ_{11} \dots VJ_{nk}$ (52), which may be entered thereinto the user interface I_n (14) therethrough the user input UI_n (25) by the user U_n (12). Typically, however, the queries $QQ_{n1} \dots QQ_{nm}$ (53) having the same and/or substantially the same values are grouped one with the other therein individual ones of the addressable query pointer/address groups $QG_{n1} \dots QG_{nz}$ (62). Default criteria may be resident within the server PS (18) and/or the client C_n (16).

The size of the request pointer/address group QZ_n (60) and which particular ones of the queries $QQ_{n1}...QQ_{nm}$ (53) and the corresponding ones of the server addresses $AQ_{n1}...AQ_{nm}$ (54) to use therein the requests $Q_{n1}...Q_{nm}$ (29), and thus construction and/or formulation of the addressable query pointer/address groups $QG_{n1}...QG_{nz}$ (62) to incorporate therein the particular request pointer/address group QZ_n (60), and, thus, delivery of information therein the query information groups $GI_{n1}...GI_{nz}$ (63) is determined by the current request groups $QA_{1c}...QA_{nc}$ (50), which may be determined from the Group 327 and the Searches per Group 326, the queries $QQ_{n1}...QQ_{nm}$ (53) and the corresponding ones of the server addresses $AQ_{n1}...AQ_{nm}$ (54) therein.

Certain ones of the queries $QQ_{n1}...QQ_{nm}$ (53) may be grouped one with the other in the addressable query pointer/address groups $QG_{n1}...QG_{nz}$ (62), which have the certain ones of the queries $QQ_{n1}...QQ_{nm}$ (53) and the corresponding ones of the server addresses $AQ_{n1}...AQ_{nm}$ (54) associated therewith, and the corresponding pointers/addresses $PP_{n11}...PP_{nmr}$ (64) associated therewith the certain ones of the queries $QQ_{n1}...QQ_{nm}$ (53), the corresponding ones of the server addresses $AQ_{n1}...AQ_{nm}$ (54), and certain ones of response information groups $RG_{n1}...RG_{nm}$ (57).

Typical sorting and/or grouping criteria, for example, may group certain ones of the queries $QQ_{n1}...QQ_{nm}$ (53) having the same and/or substantially the same values grouped therein a particular one of the query information groups $GI_{nz}...GI_{nz}$ (63), designated as the query information group GI_{nz} (63).

Alternatively and/or additionally, other typical sorting and/or grouping criteria, for example, may group certain ones of the server addresses $AQ_{n1}...AQ_{nm}$ (54), having the same and/or substantially the same values grouped therein a particular one of the query information groups $GI_{nz}...GI_{nz}$ (63), designated as the query information group GI_{nz} (63), as shown in FIG. 30.

FIGS. 28-30 show the r th pointers/addresses PP_{ner} (64), PP_{nrr} (64), and PP_{nwr} (64), which point to the r th optional addressable pointer/address indices IN_{ner} (81), IN_{nrr} (81), and IN_{nwr} (81) of the corresponding r th individual information groups LG_{ner} (80), LG_{nrr} (80), and LG_{nwr} (80) of the addressable response information groups RG_{ne} (57), RG_{nr} (57), and RG_{nw} (57) associated therewith the query pointer/address group QG_{nz} (62) and the associated query information group GI_{nz} (63).

Alternatively and/or additionally, the user U_n (12) may select query grouping criteria, which simply provides information to the user interface I_n (14), separately with respect to the individual server addresses $AQ_{n1}...AQ_{nm}$ (54), as shown in FIGS. 12 and 16. For example, the query information groups $GI_{n1}...GI_{nz}$ (63), may alternatively and/or additionally be correspondingly associated with the server address $AQ_{n1}...AQ_{nm}$ (54), and, thus, may be correspondingly associated with the addressable response information groups $RG_{n1}...RG_{nm}$ (57). The query information group GI_{n1} (63) may, thus, be associated therewith the server address AQ_{n1} (54), the addressable response information group RG_{n1} (57), and the query information group GI_{n1} (63); the query information group GI_{n2} (63) may, thus, be associated therewith the server address AQ_{n2} (54), the addressable response information group RG_{n2} (57), and the query information group GI_{n2} (63), and so on; and the query information group GI_{nz} (63)

may, thus, be associated therewith the server address AQ_{nz} (54), the addressable response information group RG_{n2} (57), and the query information group GI_{nz} (63), as shown in FIGS. 12 and 16. The process 104 of deriving the service and/or information response IR_n (34) and/or the user service and/or information response ir_n (36) for the grouping and/or sorting criteria of FIGS. 12 and 16 is shown in FIG. 22-1B.

5

The pointing/addressing scheme of FIGS. 12 and 16 is, of course, a much simpler pointing/addressing scheme than the pointing/addressing scheme of FIGS. 11 and 15, and does not require incorporating the addressable query pointer/address groups $QG_{n1}...QG_{nz}$ (62) therein to the request pointer/address group QZ_n (60). Each of the pointers/addresses $PF_{n11}...PF_{nmr}$ (69), of FIGS. 12 and 16, may then be directed to point/address the corresponding response information groups $RG_{n1}...RG_{nm}$ (57) directly therefrom the request pointer/address group QY_{ns} (68), to obtain information therefrom the corresponding response information groups $RG_{n1}...RG_{nm}$ (57) and incorporation therein to corresponding ones of the corresponding query information groups $GI_{n1}...GI_{nz}$ (63), as shown in FIGS. 12 and 16. In this case, the addressable query pointer/address groups $QG_{n1}...QG_{nz}$ (62) may be bypassed and/or eliminated completely, thus simplifying the process. Of course, then, in this case, the resulting sorting and grouping is not as sophisticated, and allows for such simplification.

15

The above sorting criteria addressing schemes are meant only as typical examples of sorting criteria addressing schemes that may be used. Yet other sorting criteria addressing schemes and/or combinations thereof may be used.

FIG. 31 shows typical ones of the addressable query pointer/address groups $QG_{n1}...QG_{nz}$ (62) having the typical ones of the queries $QQ_{n1}...QQ_{nm}$ (53), the typical ones of the server addresses $AQ_{n1}...AQ_{nm}$ (54), and the corresponding ones of typical ones of the pointers/addresses $PP_{n11}...PP_{nmr}$ (64) having the same ones of the queries $QQ_{n1}...QQ_{nm}$ (53) grouped one with the other therein individual ones of the addressable query pointer/address groups $QG_{n1}...QG_{nz}$ (62).

25

More particularly, FIG. 31 shows the query pointer/address group QG_{n1} (62), the query pointer/address group QG_{n2} (62), and the query pointer/address group QG_{n3} (62). The query pointer/address group QG_{n1} (62) of FIG. 31 has the same ones of the queries QQ_{n1} (53), QQ_{n2} (53), QQ_{n3} (53), and QQ_{n9} (53), the ones of the server addresses AQ_{n1} (54), AQ_{n2} (54), AQ_{n3} (54), and AQ_{n9} (54), and the ones of the pointers/addresses PP_{n1r} (64), PP_{n2r} (64), PP_{n3r} (64), and PP_{n9r} (64) associated therewith. The query pointer/address group QG_{n2} (62) of FIG. 31 has the same ones of the queries QQ_{n4} (53) and QQ_{n7} (53), the ones of the server addresses AQ_{n4} (54) and AQ_{n7} (54) the ones of the pointer/addresses PP_{n4r} (64) and PP_{n7r} (64) associated therewith. The query pointer/address group QG_{n3} (62) of FIG. 31 has the same ones of the query values QQ_{n5} (53), QQ_{n6} (53), and QQ_{n8} (53), the ones of the server addresses AQ_{n5} (54), AQ_{n6} (54), and AQ_{n8} (54) and the ones of the pointers/addresses PP_{n5r} (64), PP_{n6r} (64), and PP_{n8r} (64) associated therewith.

35

The addressable query pointer/address groups $QG_{n1}...QG_{nz}$ (62), however, may alternatively and/or additionally be grouped, for example, by the server addresses $AQ_{n1}...AQ_{nm}$ (54) and have the corresponding query values $QQ_{n1}...QQ_{nm}$ (53) associated therewith. Ones of the same and/or substantially the same ones of the server

addresses $AQ_{n1} \dots AQ_{nm}$ (54), for example, having the corresponding queries $QQ_{n1} \dots QQ_{nm}$ (53) associated therewith may be used as the grouping criteria.

FIG. 32 shows another schematic representation of the typical ones of the addressable query pointer/address groups $QG_{n1} \dots QG_{nz}$ (62) having the typical ones of the queries $QQ_{n1} \dots QQ_{nm}$ (53), the typical ones of the server addresses $AQ_{n1} \dots AQ_{nm}$ (54), and the typical the ones of the pointer/addresses $PP_{n11} \dots PP_{nmr}$ (64) of FIG. 31 associated therewith.

FIG. 33 is a generic schematic representation of the addressable query pointer/address groups $QG_{n1} \dots QG_{nz}$ (62) having the queries $QQ_{n1} \dots QQ_{nm}$ (53), the server addresses $AQ_{n1} \dots AQ_{nm}$ (54), and the pointers/addresses $PP_{n11} \dots PP_{nmr}$ (64) associated therewith.

Certain information therein the addressable response information groups $RG_{n1} \dots RG_{nm}$ (57) may be associated with the corresponding queries $QQ_{n1} \dots QQ_{nm}$ (53) and/or the corresponding server addresses $AQ_{n1} \dots AQ_{nm}$ (54) within the current request group QA_{nc} (50), and may optionally be used by the server PS (18) and/or the client C_n (16).

Certain information therein the addressable response information groups $RG_{n1} \dots RG_{nm}$ (57) may also be incorporated thereinto the optional instructions $VJ_{n1} \dots VJ_{nk}$ (52). Such information may be incorporated thereinto the optional instructions $VJ_{n1} \dots VJ_{nk}$ (52) may also be additionally and/or alternatively optionally resident within the server PS (18) and/or the client C_n (16).

J. COMMUNICATING THE REQUESTS TO THE SERVERS

The server PS (18) and/or the clients $C_1 \dots C_n$ (16) contact and open the connections $OC_{11} \dots OC_{nm}$ (323) with ones of the servers $S_1 \dots S_z$ (20), according to the server designations $S_{11} \dots S_{nm}$ (30) at the corresponding server addresses $A_{11} \dots A_{nu}$ (265) at corresponding ports $W_{11} \dots W_{nm}$ (343). The server PS (18) and/or the clients $C_1 \dots C_n$ (16) communicate the requests $Q_{11} \dots Q_{nm}$ (29) of one or more of the same and/or different ones of the servers $S_1 \dots S_z$ (20), designated within the Group 327 and the Searches per Group 326 to make the requests $Q_{11} \dots Q_{nc}$ (29) thereof, in accordance with the designation scheme corresponding to the corresponding ones of the server designations $S_{11} \dots S_{nm}$ (30), corresponding to the requests $Q_{11} \dots Q_{nm}$ (29). If the Group 327 is not specified and/or the Searches per Group 326 are not specified by the users $U_1 \dots U_n$ (12), default values may additionally and/or alternatively values be used.

A particular one of the requests $Q_{11} \dots Q_{nm}$ (29), hereinafter designated as the request Q_{nm} (29), corresponding to one request within the requests $Q_{n1} \dots Q_{nm}$ (29) corresponding to the user U_n (12), is shown schematically in FIG. 34.

Information 344 may be used for formulating a typical particular one of the requests Q_{nm} (29) from the service and/or information request IQ_n (28), and parsing, processing, and/or formatting the optional instructions $VJ_{n1} \dots VJ_{nk}$ (52), and opening the connection OC_{nm} (323).

Now, in more detail, the request Q_{nm} (29) may have a corresponding request line L_{nm} (345), corresponding optional request header fields $JH_{n1} \dots JH_{ns}$ (346), and a corresponding optional entity body EH_{nm} (347). The request line L_{nm} (345) may have a corresponding method M_{nm} (348), a corresponding target resource P_{nm} (349), which may
 5 have information associated with the corresponding query QQ_{nm} (53), and corresponding protocol B_{nm} (350).

The user U_n (12), the server PS (18) and/or the client C_n (16) may optionally specify the port W_{nm} (343) to communicate the request Q_{nm} (29) therethrough, and/or the method M_{nm} (348), and/or the protocol B_{nm} (350). The port W_{nm} (343), and/or the method M_{nm} (348), and/or the protocol B_{nm} (350) may optionally be resident within the
 10 server PS (18) and/or the client C_n (16). Default values may also be used for the port W_{nm} (343) and/or the protocol B_{nm} (350).

Typically, information within or from any and/or all or a portion of the queries QQ_{nm} (53) may be incorporated into the corresponding ones of the target resources $P_{11} \dots P_{nm}$ (349) and/or the corresponding ones of the optional entity
 15 bodies $EH_{11} \dots EH_{nm}$ (347), and may in certain instances depend upon the method $M_{11} \dots M_{nm}$ (348).

However, information that may be used for opening the connections $OC_{11} \dots OC_{nm}$ (323) and formulating the requests $Q_{11} \dots Q_{nm}$ (29) from the service and/or information requests $IQ_1 \dots IQ_n$ (28) may be derived from any and/or all or a portion of the user client requests $QC_{11} \dots QC_{nu}$ (280) accessible to the users $U_1 \dots U_n$ (12) and/or the
 20 hidden client requests $HC_{n1} \dots HC_{nh}$ (281) hidden from the users $U_1 \dots U_n$ (12), and/or a combination thereof, and/or may also have information and/or instructions to be utilized by the server PS (18) and/or ones of the clients $C_1 \dots C_n$ (16).

Alternatively information from the alternate request links $QL_{11} \dots QL_{na}$ (203), and/or the server request links
 25 $UL_{11} \dots UL_{ns}$ (204), and/or the additional request links $SL_{11} \dots SL_{nw}$ (71), and/or a combination thereof, may be used by the server PS (18) and/or ones of the clients $C_1 \dots C_n$ (16) to formulate the requests $Q_{11} \dots Q_{nm}$ (29).

There may be m different or same ones of the requests $Q_{n1} \dots Q_{nm}$ (29) from the client C_n (16) at any time, and $n \times m$ different and/or same ones of the requests $Q_{11} \dots Q_{nm}$ (29) of the same and/or different ones of the servers $S_1 \dots S_z$
 30 (20) present on the network 24 at any time.

The queries $QQ_{n1} \dots QQ_{nm}$ (53) may each be different, one from the other, or the same. The queries $QS_{n1} \dots QS_{nu}$ (288) accessible to the user U_n (12) may each be different, one from the other, or the same. The hidden queries $QH_{n1} \dots QH_{nh}$ (290) may each be different, one from the other, or the same. The number of the queries
 35 $QQ_{n1} \dots QQ_{nm}$ (53) "m" may be substantially the sum of the queries $QS_{n1} \dots QS_{nu}$ (288) accessible to the user U_n (12) and the hidden queries $QH_{n1} \dots QH_{nh}$ (290), i.e., $m = u + h$.

There may be m different or same ones of the queries $QQ_{n1} \dots QQ_{nm}$ (53) corresponding to the requests $Q_{n1} \dots Q_{nm}$ (29) from the client C_n (16) at any time, and $n \times m$ different and/or same ones of the queries $QQ_{11} \dots QQ_{nm}$ (53)

corresponding to the requests $Q_{11} \dots Q_{nm}$ (29) of the same and/or different ones of the servers $S_1 \dots S_z$ (20) present on the network 24 at any time.

The server addresses $AQ_{n1} \dots AQ_{nm}$ (54) may each be different, one from the other, or the same. The server addresses $A_{n1} \dots A_{nu}$ (265) accessible to the user U_n (12) may each be different, one from the other, or the same. The hidden server addresses $AH_{n1} \dots AH_{nh}$ (291) may each be different, one from the other, or the same. The number of the server addresses $AQ_{n1} \dots AQ_{nm}$ (54) "m" may be substantially the sum of the server addresses $A_{n1} \dots A_{nu}$ (265) accessible to the user U_n (12) and the hidden server addresses $AH_{n1} \dots AH_{nh}$ (291), i.e., $m = u + h$.

10 There may be m different or same ones of the server addresses $AQ_{n1} \dots AQ_{nm}$ (54) corresponding to the requests $Q_{n1} \dots Q_{nm}$ (29) from the client C_n (16) at any time, and $n \times m$ different and/or same ones of the server addresses $AQ_{11} \dots AQ_{nm}$ (54) corresponding to the requests $Q_{11} \dots Q_{nm}$ (29) of the same and/or different ones of the servers $S_1 \dots S_z$ (20) present on the network 24 at any time.

15 The optional instructions $VJ_{n1} \dots VJ_{nk}$ (52) may each be different, one from the other, or the same. The optional instructions $V_{n1} \dots V_{nv}$ (289) accessible to the user U_n (12) may each be different, one from the other, or the same. The optional hidden instructions $H_{n1} \dots H_{ni}$ (292) may each be different, one from the other, or the same. The number of the optional instructions $VJ_{n1} \dots VJ_{nk}$ (52) "k" may be substantially the sum of the optional instructions $V_{n1} \dots V_{nv}$ (289) accessible to the user U_n (12) and The optional hidden instructions $H_{n1} \dots H_{ni}$ (292), i.e., $k = v + i$.

20 There may be $m \times k$ different or same ones of the optional instructions $VJ_{n1} \dots VJ_{nk}$ (52) corresponding to the requests $Q_{n1} \dots Q_{nm}$ (29) from the client C_n (16) at any time, and $n \times m \times k$ different and/or same ones of the optional instructions $VJ_{11} \dots VJ_{nk}$ (52) corresponding to the requests $Q_{11} \dots Q_{nm}$ (29) of the same and/or different ones of the servers $S_1 \dots S_z$ (20) present on the network 24 at any time.

25 The requests $Q_{11} \dots Q_{nm}$ (29) of the servers $S_1 \dots S_z$ (20) may be made at the same and/or different times. One or more of the requests $Q_{11} \dots Q_{nm}$ (29) may be made of each of the servers $S_1 \dots S_z$ (20) by the same and/or different ones of the clients $C_1 \dots C_n$ (16) and/or the server PS (18) at the same and/or different times.

30 The server PS (18) and/or the client C_n (16) may make one or more of the requests $Q_{n1} \dots Q_{nm}$ (29) of the same and/or different ones of the servers $S_1 \dots S_z$ (20), in accordance with the designation scheme corresponding to the corresponding ones of the server designations $S_{n1} \dots S_{nm}$ (30), in order to fulfill the services and/or information requirements of the user U_n (12).

35 K. REPLIES FROM THE SERVERS

Each of the servers $S_1 \dots S_z$ (20) communicated therewith replies to the server PS (18) and/or the clients $C_1 \dots C_n$ (16), in accordance with the designation scheme which designates the servers $S_1 \dots S_z$ (20) being communicated with corresponding to the requests $Q_{11} \dots Q_{nm}$ (29) as the corresponding server designations $S_{11} \dots S_{nm}$ (30), and

communicates the corresponding responses $R_{11} \dots R_{nm}$ (32), associated therewith the requests $Q_{11} \dots Q_{nm}$ (29), to the server **PS** (18) and/or the clients $C_1 \dots C_n$ (16) making the requests $Q_{11} \dots Q_{nm}$ (29).

Now, ones of the servers $S_1 \dots S_z$ (20) having been contacted by the server **PS** (18) and/or the clients $C_1 \dots C_n$ (16) and the connections opened $OC_{11} \dots OC_{nm}$ (323) therewith, corresponding to the requests $Q_{11} \dots Q_{nm}$ (29), according to the server designations $S_{11} \dots S_{nm}$ (30) at the corresponding server addresses $A_{11} \dots A_{nu}$ (265) at the corresponding ports $W_{11} \dots W_{nm}$ (343) reply to the server **PS** (18) and/or the contacting clients $C_1 \dots C_n$ (16) with the corresponding responses $R_{11} \dots R_{nm}$ (32).

A particular one of the responses $R_{n1} \dots R_{nm}$ (32), hereinafter designated as the response R_{nm} (32), corresponding to one response within the responses $R_{n1} \dots R_{nm}$ (32), the response R_{nm} (32) corresponding to the request Q_{nm} (29), and the responses $R_{n1} \dots R_{nm}$ (32) corresponding to the requests $Q_{n1} \dots Q_{nm}$ (29), is shown schematically in FIG. 35.

Now, the response R_{nm} (32) may have a corresponding response header line LR_{nm} (351), corresponding optional response header fields $JR_{n1} \dots JR_{nt}$ (352), and a corresponding optional entity body RH_{nm} (353). The optional entity body RH_{nm} (353) typically has links, and/or descriptions, and/or other information. The request header line LR_{nm} (351) may have a corresponding protocol BR_{nm} (354), a corresponding status SR_{nm} (355), and a corresponding status explanation SE_{nm} (356).

Ones of the connections may be closed after ones of the responses $R_{11} \dots R_{nm}$ (32) are communicated to the **PS** (18) and/or to the requesting corresponding ones of the clients $C_1 \dots C_n$ (16).

Again, the Timeout per Search Engine 329 is considered to be substantially the maximum time for the server **PS** (18) and/or the particular client C_n (16) making the requests $Q_{n1} \dots Q_{nm}$ (29) to wait for each of the responses $R_{n1} \dots R_{nm}$ (32) therefrom certain ones of the servers $S_1 \dots S_z$ (20), in accordance with the designation scheme which designates the certain ones of the servers $S_1 \dots S_z$ (20) to be communicated with corresponding to the requests $Q_{11} \dots Q_{nm}$ (29) as the corresponding server designations $S_{11} \dots S_{nm}$ (30).

If certain ones of the servers $S_1 \dots S_z$ (20) do not open connections $OC_{11} \dots OC_{nm}$ (323) therewith and/or communicate the responses $R_{11} \dots R_{nm}$ (32) thereto the server **PS** (18) and/or the clients $C_1 \dots C_n$ (16), and/or if certain other ones of the servers $S_1 \dots S_z$ (20) do not communicate the responses $R_{11} \dots R_{nm}$ (32) thereto the server **PS** (18) and/or the clients $C_1 \dots C_n$ (16) once connections therewith may have been opened $OC_{11} \dots OC_{nm}$ (323), corresponding to the requests $Q_{11} \dots Q_{nm}$ (29), according to the server designations $S_{11} \dots S_{nm}$ (30), within the timeout set by the Timeout per Search Engine 329, the certain ones of requests $Q_{n1} \dots Q_{nm}$ (29) of such nonresponding ones of the servers $S_1 \dots S_z$ (20) may then be cancelled by the server **PS** (18) and/or the clients $C_1 \dots C_n$ (16). Information about such ones of the nonresponding ones of the servers $S_1 \dots S_z$ (20) may then be communicated therefrom the server **PS** (18) and/or the clients $C_1 \dots C_n$ (16) therethrough the corresponding ones of the user interfaces $I_1 \dots I_n$ (14) thereto the corresponding ones of the users $U_1 \dots U_n$ (12), according to the server

designations $S_{11}...S_{nm}$ (30) corresponding to the certain ones of requests $Q_{n1}...Q_{nm}$ (29) of such nonresponding ones of the servers $S_1...S_z$ (20).

In certain instances, the server **PS (18)** and/or certain ones of the clients $C_1...C_n$ (16) may contact certain ones of the servers $S_1...S_z$ (20) and open the connections $OC_{11}...OC_{nm}$ (323) therewith, corresponding to the requests $Q_{11}...Q_{nm}$ (29), according to the server designations $S_{11}...S_{nm}$ (30), one or more additional times, in order to satisfy the needs of the users $U_1...U_n$ (12), and/or certain requirements within the optional instructions $VJ_{n1}...VJ_{nk}$ (52), such as, for example, the URL's per Search Engine 330, and/or as a result of certain information communicated to the **PS (18)** and/or certain ones of the clients $C_1...C_n$ (16) within the responses $R_{11}...R_{nm}$ (32).

10

If, for example, less links, and/or descriptions, and/or prices/values, and/or images are returned within certain ones of the responses $R_{11}...R_{nm}$ (32), which may be considered to be first ones of the responses $R_{11}...R_{nm}$ (32), than are requested by certain ones of the users $U_1...U_n$ (12) within certain ones of the URL's per Search Engine 330, the server **PS (18)** and/or certain ones of the clients $C_1...C_n$ (16) may contact certain ones of the servers $S_1...S_z$ (20), open the connections $OC_{11}...OC_{nm}$ (323) therewith, and make additional ones of the requests $Q_{11}...Q_{nm}$ (29), according to the server designations $S_{11}...S_{nm}$ (30), one or more additional times, in order to satisfy the needs of the users $U_1...U_n$ (12). The links, and/or the descriptions, and/or the images returned within and/or parsed therefrom additional ones of the responses $R_{11}...R_{nm}$ (32) thereto the additional ones of the requests $Q_{11}...Q_{nm}$ (29) may then be appended thereto the corresponding ones of the links, and/or the corresponding ones of the descriptions, and/or the corresponding ones of the images returned within and parsed therefrom the first ones of the responses $R_{11}...R_{nm}$ (32)

20

The servers $S_1...S_z$ (20) communicate the responses $R_{11}...R_{nm}$ (32) to the requests $Q_{11}...Q_{nm}$ (29) thereto the server **PS (18)** and/or specific ones of the clients $C_1...C_n$ (16), in accordance with the designation scheme corresponding to the corresponding ones of the server designations $S_{11}...S_{nm}$ (30). Alternatively, and/or additionally, in certain instances, certain ones of the servers $S_1...S_z$ (20), corresponding to certain ones of the server designations $S_{11}...S_{nm}$ (30), may request additional information of the server **PS (18)** and/or specific ones of the clients $C_1...C_n$ (16), prior to communicating the responses $R_{11}...R_{nm}$ (32) to the requests $Q_{11}...Q_{nm}$ (29). Upon receiving such additional information from the server **PS (18)** and/or the specific ones of the clients $C_1...C_n$ (16), the certain ones of the servers $S_1...S_z$ (20), corresponding to the certain ones of the server designations $S_{11}...S_{nm}$ (30), may then communicate the responses $R_{11}...R_{nm}$ (32) to the requests $Q_{11}...Q_{nm}$ (29) thereto the server **PS (18)** and/or the specific ones of the clients $C_1...C_n$ (16).

25

30

In such certain instances, in more detail, the server **PS (18)** and/or certain ones of the clients $C_1...C_n$ (16) may contact certain ones of the servers $S_1...S_z$ (20) and open the connections $OC_{11}...OC_{nm}$ (323) therewith, corresponding to the requests $Q_{11}...Q_{nm}$ (29), according to the server designations $S_{11}...S_{nm}$ (30), one or more additional times, as a result of certain information communicated to the **PS (18)** and/or certain ones of the clients $C_1...C_n$ (16) within the responses $R_{11}...R_{nm}$ (32), such as, for example, information obtained from and/or parsed from the responses $R_{11}...R_{nm}$ (32). This information is typically within certain ones of the response header fields

35

JR₁₁...JR_{nt} (352), but may also be within the corresponding optional entity bodies **RH₁₁...RH_{nm} (353)** and/or the corresponding response header lines **LR₁₁...LR_{nm} (351)**.

Now, in such certain instances, the certain ones of the servers **S₁...S_z (20)** request the information from the server **PS (18)** and/or certain ones of the clients **C₁...C_n (16)**, prior to communicating the responses **R₁₁...R_{nm} (32)** thereto the server **PS (18)** and/or the certain ones of the clients **C₁...C_n (16)**. The server **PS (18)** and/or the certain ones of the clients **C₁...C_n (16)** being requested such information may then respond to the requests for such information, by communicating the requested information to the ones of the requesting servers **S₁...S_z (20)**. Upon receipt of the requested information at the ones of the requesting servers **S₁...S_z (20)**, the requesting ones of the servers **S₁...S_z (20)** reply thereto the server **PS (18)** and/or the certain ones of the clients **C₁...C_n (16)** with the responses **R₁₁...R_{nm} (32)**. Such requests for information from the servers **S₁...S_z (20)** may occur not at all, and/or one or more times.

L. PARSING, PROCESSING, FORMATTING, SORTING, GROUPING, AND ORGANIZING RESPONSES INTO SERVICE AND/OR INFORMATION RESPONSES

A particular one of the optional entity bodies **RH₁₁...RH_{nm} (353)**, designated as the entity body **RH_{nm} (353)**, of a particular one of the responses **R₁₁...R_{nm} (32)**, designated as the response **R_{nm} (32)**, may have optional response individual information groups **LS_{nm1}...LS_{nmr} (360)** and optional information **LI_{nm} (361)**, as shown in FIG. 36.

Each of the optional response individual information groups **LS_{nm1}...LS_{nmr} (360)** may have and/or be parsed into corresponding optional response links **LK_{nm1}...LK_{nmr} (362)**, and/or corresponding optional response descriptions **DK_{nm1}...DK_{nmr} (363)**, and/or corresponding optional response prices/values **PK_{nm1}...PK_{nmr} (364)**, and/or corresponding optional response images **IK_{nm1}...IK_{nmr} (365)**, as shown in FIG. 36.

The optional response links **LK_{nm1}...LK_{nmr} (362)**, the corresponding optional response descriptions **DK_{nm1}...DK_{nmr} (363)**, the corresponding optional response prices/values **PK_{nm1}...PK_{nmr} (364)**, and the corresponding optional response images **IK_{nm1}...IK_{nmr} (365)**, corresponding to the optional response individual information groups **LS_{nm1}...LS_{nmr} (360)** are typically associated correspondingly one with the other.

The optional response link **LK_{nm1} (362)**, the corresponding optional response description **DK_{nm1} (363)**, the corresponding optional response price/value **PK_{nm1} (364)**, and the corresponding optional response image **IK_{nm1} (365)**, corresponding to the optional response individual information group **LS_{nm1} (360)** are typically associated correspondingly one with the other. The optional response link **LK_{nm2} (362)**, the corresponding optional response description **DK_{nm2} (363)**, the corresponding optional response price/value **PK_{nm2} (364)**, and the corresponding optional response image **IK_{nm2} (365)**, corresponding to the optional response individual information group **LS_{nm2} (360)** are typically associated correspondingly one with the other, and so on. The optional response link **LK_{nmr} (362)**, the corresponding optional response description **DK_{nmr} (363)**, the corresponding optional response price/value **PK_{nmr} (364)**, and the corresponding optional response image **IK_{nmr} (365)**, corresponding to the optional

response individual information group **LS_{n_mr}** (360) are, thus, typically associated correspondingly one with the other.

The optional information **LI_{n_m}** (361) may have additional links, and/or additional descriptions, and/or additional images, and/or prices/values, and/or other information, and/or services, and/or media, all and/or a portion of which may be used and/or discarded by the server **PS** (18) and/or the clients **C₁...C_n** (16). The optional information **LI_{n_m}** (361) is typically filtered from the optional entity body **RH_{n_m}** (353) and discarded, and/or other unwanted information and/or media is also typically filtered from the response **R_{n_m}** (32), and/or the optional entity body **RH_{n_m}** (353), and discarded.

10

The optional response individual information groups **LS_{n_m1}...LS_{n_mr}** (360) are typically parsed and/or processed and/or formatted therefrom the entity body **RH_{n_m}** (353) of the response **R_{n_m}** (32), and/or parsed, and/or processed, and/or formatted, and/or organized, and/or grouped thereinto the addressable individual information groups **LG_{n_m1}...LG_{n_mr}** (80) of the addressable response information group **RG_{n_m}** (57), correspondingly associated therewith the response **R_{n_m}** (32), as shown in FIGS. 37 and 38.

15

FIG. 37 shows the addressable response information group **RG_{n_m}** (57) having the addressable individual information groups **LG_{n_m1}...LG_{n_mr}** (80) parsed, and/or processed, and/or formatted, and/or organized, and/or grouped thereinto the addressable response information group **RG_{n_m}** (57) therefrom the optional entity body **RH_{n_m}** (353) of FIG. 36.

20

FIG. 38 shows a particular one of the optional response individual information groups **LS_{n_m1}...LS_{n_mr}** (360), designated as the optional response individual information group **LS_{n_mr}** (360), parsed, and/or processed, and/or formatted, and/or organized, and/or grouped thereinto a particular one of the addressable individual information groups **LG_{n_m1}...LG_{n_mr}** (80), designated as the addressable individual information group **LG_{n_mr}** (80).

25

The addressable individual information groups **LG_{n_m1}...LG_{n_mr}** (80) are typically parsed, and/or processed, and/or formatted for consistency of presentation and/or appearance one with the other, as the addressable individual information groups **LG_{n_m1}...LG_{n_mr}** (80) are incorporated thereinto the addressable response information group **RG_{n_m1}...RG_{n_m}** (57) therefrom the responses **R_{n_m1}...R_{n_m}** (32).

30

Alternatively and/or additionally the addressable individual information groups **LG_{n_m1}...LG_{n_mr}** (80) may be incorporated thereinto the addressable response information group **RG_{n_m1}...RG_{n_m}** (57) therefrom the responses **R_{n_m1}...R_{n_m}** (32) in an as-is condition and/or in raw form.

35

The optional response links **LK_{n_m1}...LK_{n_mr}** (362) are typically parsed, and/or processed, and/or formatted thereinto the corresponding optional links **LD_{n_m1}...LD_{n_mr}** (82). The optional response descriptions **DK_{n_m1}...DK_{n_mr}** (363) are typically parsed, and/or processed, and/or formatted thereinto the optional descriptions **DD_{n_m1}...DD_{n_mr}** (83). The optional response prices/values **PK_{n_m1}...PK_{n_mr}** (364) are typically parsed, and/or processed, and/or formatted

thereinto the corresponding optional prices/values $PD_{nm1} \dots PD_{nmr}$ (84). The optional response images $IK_{nm1} \dots IK_{nmr}$ (365) are typically parsed, and/or processed, and/or formatted thereinto the corresponding optional images $ID_{nm1} \dots ID_{nmr}$ (85).

- 5 Each of the optional links $LD_{nm1} \dots LD_{nmr}$ (82) are also typically parsed, and/or processed, and/or formatted for consistency of presentation and/or appearance one with the other. Alternatively and/or additionally the optional links $LD_{nm1} \dots LD_{nmr}$ (82) may be retained in an as-is condition and/or in raw form.

- Each of the optional descriptions $DD_{nm1} \dots DD_{nmr}$ (83) are also typically parsed, and/or processed, and/or formatted
10 for consistency of presentation and/or appearance one with the other. Alternatively and/or additionally the optional links optional descriptions $DD_{nm1} \dots DD_{nmr}$ (83) may be retained in an as-is condition and/or in raw form.

- Each of the optional prices/values $PD_{nm1} \dots PD_{nmr}$ (84) are also typically parsed, and/or processed, and/or formatted for consistency of presentation and/or appearance one with the other. Alternatively and/or additionally the optional
15 prices/values $PD_{nm1} \dots PD_{nmr}$ (84) may be retained in an as-is condition and/or in raw form.

- Each of the optional images $ID_{nm1} \dots ID_{nmr}$ (85) are also typically parsed, and/or processed, and/or formatted for consistency of presentation and/or appearance one with the other. Alternatively and/or additionally the optional images $ID_{nm1} \dots ID_{nmr}$ (85) may be retained in an as-is condition and/or in raw form.

20

- The optional links $LD_{nm1} \dots LD_{nmr}$ (82), and/or the optional descriptions $DD_{nm1} \dots DD_{nmr}$ (83), and/or the optional prices/values $PD_{nm1} \dots PD_{nmr}$ (84), and/or the optional images $ID_{nm1} \dots ID_{nmr}$ (85), correspondingly associated therewith the response R_{nm} (32), may additionally and/or alternatively be parsed individually and/or separately, and incorporated thereinto the addressable response information group RG_{nm} (57) therefrom the optional entity body
25 RH_{nm} (353), as shown in FIG. 39.

The response header line LR_{nm} (351) and/or the optional response header fields $JR_{n1} \dots JR_{nt}$ (352) may also have information, which the server PS (18) and/or the clients $C_1 \dots C_n$ (16) may use.

- 30 The optional information LI_{nm} (361) and/or certain information and/or media within the response R_{nm} (32), particularly within the optional entity body RH_{nm} (353), may be optionally used by the server PS (18) and/or the clients $C_1 \dots C_n$ (16), and/or optionally incorporated thereinto the addressable response information group RG_{nm} (57).

- 35 Each of the optional response individual information groups $LS_{nm1} \dots LS_{nmr}$ (360) therefrom each of the responses $R_{n1} \dots R_{nm}$ (32) may be compared one with the other, and duplicate ones of the of the optional response individual information groups $LS_{nm1} \dots LS_{nmr}$ (360) may be discarded.

Alternatively and/or additionally, each of the optional addressable individual information groups $LG_{n11} \dots LG_{nmr}$ (80) therefrom each of the addressable response information groups $RG_{n1} \dots RG_{nm}$ (57) may be compared one with the other, and duplicate ones of the optional addressable individual information groups $LG_{n11} \dots LG_{nmr}$ (80) may be discarded.

5

Each of the optional response individual information groups $LS_{111} \dots LS_{nmr}$ (360) and/or portions thereof therefrom the entity bodies $RH_{11} \dots RH_{nm}$ (353) of the responses $R_{11} \dots R_{nm}$ (32) may also be optionally compared one with the other, and duplicate ones of the optional response individual information groups $LS_{111} \dots LS_{nmr}$ (360) may be optionally discarded.

10

Alternatively and/or additionally, each of the optional links $LK_{n11} \dots LK_{nmr}$ (362), and/or the optional descriptions $DK_{n11} \dots DK_{nmr}$ (363), and/or the optional prices/values $PD_{nm1} \dots PD_{nmr}$ (365), and/or the optional images $IK_{n11} \dots IK_{nmr}$ (365), therefrom each of the responses $R_{n1} \dots R_{nm}$ (32) may be compared one with the other of like kind, and duplicate ones of the optional links $LK_{n11} \dots LK_{nmr}$ (362), and/or the optional descriptions $DK_{n11} \dots DK_{nmr}$ (363), and/or the optional prices/values $PK_{nm1} \dots PK_{nmr}$ (364), and/or the optional images $IK_{n11} \dots IK_{nmr}$ (364), and/or a combination thereof may be discarded.

15

Alternatively and/or additionally, each of the optional links $LD_{n11} \dots LD_{nmr}$ (82), and/or the optional descriptions $DD_{n11} \dots DD_{nmr}$ (83), and/or the optional prices/values $PD_{nm1} \dots PD_{nmr}$ (84), and/or the optional images $ID_{n11} \dots ID_{nmr}$ (85) therefrom each of the addressable response information groups $RG_{n1} \dots RG_{nm}$ (57) may be compared one with the other of like kind, and duplicate ones of the optional links $LD_{n11} \dots LD_{nmr}$ (82), and/or the optional descriptions $DD_{n11} \dots DD_{nmr}$ (83), and/or the optional prices/values $PD_{nm1} \dots PD_{nmr}$ (85), and/or the optional images $ID_{n11} \dots ID_{nmr}$ (85), and/or a combination thereof may be discarded.

20

The optional links $LK_{n11} \dots LK_{nmr}$ (362) are typically compared one with the other, and duplicate ones of the corresponding optional links $LK_{n11} \dots LK_{nmr}$ (362), and/or the corresponding optional descriptions $DK_{n11} \dots DK_{nmr}$ (363), and/or the corresponding optional images $IK_{n11} \dots IK_{nmr}$ (364), and/or the corresponding optional prices/values $PK_{nm1} \dots PK_{nmr}$ (365) are discarded, leaving only one of any ones of the duplicate optional links $LK_{n11} \dots LK_{nmr}$ (362) and/or the corresponding optional descriptions $DK_{n11} \dots DK_{nmr}$ (363), and/or the corresponding optional images $IK_{n11} \dots IK_{nmr}$ (364), and/or the optional prices/values $PK_{nm1} \dots PK_{nmr}$ (365) remaining.

25

30

The optional prices/values $PD_{nm1} \dots PD_{nmr}$ (84) and/or the corresponding optional links $LD_{n11} \dots LD_{nmr}$ (82) and/or the corresponding optional descriptions $DD_{n11} \dots DD_{nmr}$ (83), and/or the corresponding optional images $ID_{n11} \dots ID_{nmr}$ (85) may be sorted with respect to the optional prices/values $PD_{nm1} \dots PD_{nmr}$ (84), in accordance with sorting criteria in the optional instructions $VJ_{n1} \dots VJ_{nk}$ (52) and/or in accordance with default criteria resident within the server PS (18) and/or the client C_n (16).

35

The optional links $LD_{n11} \dots LD_{nmr}$ (82), and/or the corresponding optional descriptions $DD_{n11} \dots DD_{nmr}$ (83), and/or the corresponding optional prices/values $PD_{nm1} \dots PD_{nmr}$ (84), and/or the corresponding optional images $ID_{n11} \dots ID_{nmr}$ (85) may be sorted, for example, in ascending order with respect to the optional prices/values $PD_{nm1} \dots PD_{nmr}$ (84) having the lowest price therein being presented to the user U_n (12) at the user interface I_n (14) first and the highest price therein last.

Alternatively and/or additionally, the optional links $LD_{n11} \dots LD_{nmr}$ (82), and/or the corresponding optional descriptions $DD_{n11} \dots DD_{nmr}$ (83), and/or the corresponding optional prices/values $PD_{nm1} \dots PD_{nmr}$ (84), and/or the corresponding optional images $ID_{n11} \dots ID_{nmr}$ (85) may be sorted, for example, in ascending or descending alphabetical order with respect to the optional links $LD_{n11} \dots LD_{nmr}$ (82) and/or the corresponding optional descriptions $DD_{n11} \dots DD_{nmr}$ (83) being presented to the user U_n (12) at the user interface I_n (14).

Other sorting criteria may be used for the optional links $LD_{n11} \dots LD_{nmr}$ (82), and/or the optional descriptions $DD_{n11} \dots DD_{nmr}$ (83), and/or the optional prices/values $PD_{nm1} \dots PD_{nmr}$ (84), and/or the optional images $ID_{n11} \dots ID_{nmr}$ (85), and may depend upon needs of the user U_n (12). The sorting criteria may be determined by the user U_n (12).

Sorting criteria gives the user U_n (12) the ability to formulate how information is presented to the user U_n (12) at the user U_n (12), and may be incorporated therein into the optional instructions $VJ_{n1} \dots VJ_{nk}$ (52), which may be entered thereinto the user interface I_n (14) therethrough the user input UI_n (25) by the user U_n (12). The sorting criteria may additionally and/or alternatively be resident within the server PS (18) and/or the client C_n (16).

Now again, the labelled individual information group LL_{nzu} (86) associated therewith the addressable query information group GI_{nz} (63) has the optional group identifier GL_{nc} (87), the optional query link identifier LN_{ncu} (88), the optional resource location identifier SU_{nw} (89), the optional server and/or query identifier SI_{nm} (90), and/or the optional server link identifier LX_{nmr} (91) appended thereto the addressable individual information group LG_{nmr} (80), as shown in FIG. 20.

FIGS. 40 and 41 show typical ones of the addressable query information group GI_{nz} (63), based upon certain sorting and/or grouping criteria, having the labelled individual information groups $LL_{nz1} \dots LL_{nzu}$ (86), the optional database labelled individual information groups $RL_{nz1} \dots RL_{nzk}$ (92), the optional query description QT_{nz} (93), the optional server descriptions and/or links $ST_{nz1} \dots ST_{nzk}$ (94), and the optional advertisements and/or links $LT_{nz1} \dots LT_{nzk}$ (95) incorporated therein into certain typical ones of the typical service and/or information response forms IS_n (39).

The client-server multitasking system 10 of the present invention, the client-server multitasking process 99, and the multitasking process 104, the server PS (18) and/or the clients $C_1 \dots C_n$ (16), then, are capable of retrieving, parsing, processing, formatting, organizing, grouping, sorting, and consolidating services and/or information therefrom the same and/or different ones of the servers $S_1 \dots S_z$ (20), and/or the optional servers $SO_1 \dots SO_p$ (22), and/or the clients $C_1 \dots C_n$ (16), having the same and/or different structures, formats, organizations, groupings,

and/or data structures, and incorporating the parsed, processed, formatted, organized, grouped, sorted, and consolidated services and/or information thereinto the user responses $UR_1...UR_n$ (37) for delivery to the user interfaces $I_1...I_n$ (14) and use by the users $U_1...U_n$ (12).

- 5 The client-server multitasking system 10 of the present invention, the client-server multitasking process 99, and the multitasking process 104, the server PS (18) and/or the clients $C_1...C_n$ (16), then, are capable of retrieving, parsing, processing, formatting, organizing, grouping, sorting, and consolidating services and/or information therefrom the same and/or different ones of each of the optional response individual information groups $LS_{111}...LS_{nmr}$ (360), and/or the optional response links $LK_{111}...LK_{nmr}$ (362), and/or the optional response
- 10 descriptions $DK_{111}...DK_{nmr}$ (363), and/or the optional response prices/values $PK_{111}...PK_{nmr}$ (364), and/or the optional response images $IK_{nm1}...IK_{nmr}$ (365) therefrom the entity bodies $RH_{111}...RH_{nm}$ (353) of the responses $R_{111}...R_{nm}$ (32), having the same and/or different structures, formats, organizations, groupings, and/or data structures, and incorporating the parsed, processed, formatted, organized, grouped, sorted, and consolidated services and/or information thereinto the user responses $UR_1...UR_n$ (37) for delivery to the user interfaces $I_1...I_n$ (14) and
- 15 use by the users $U_1...U_n$ (12).

M. TYPICAL SERVICE AND/OR INFORMATION ENTRY REQUEST FORMS, TYPICAL COMPLETED SERVICE AND/OR INFORMATION ENTRY REQUEST FORMS, AND TYPICAL SERVICE AND/OR INFORMATION RESPONSE FORMS

- 20 FIG. 42 shows a typical one of service and/or information entry request forms $IE_1...IE_n$ (38) at the user interfaces $I_1...I_n$ (14), which the users $U_1...U_n$ (12) may communicate typical ones of the user inputs $UI_1...UI_n$ (25) thereinto, as requests for information and/or services. The typical ones of the service and/or information entry request forms $IE_1...IE_n$ (38) at the user interfaces $I_1...I_n$ (14) shown in FIGS. 42 is a typical example one of the service and/or
- 25 information entry request forms $IE_1...IE_n$ (38) at the user interfaces $I_1...I_n$ (14), a much larger variety of which is possible. Names and/or links and/or other information are incorporated therein the typical one of the service and/or information entry request forms $IE_1...IE_n$ (38) shown in FIG. 42 are for illustrative purposes, and are not intended to limit the large variety of the service and/or information entry request forms $IE_1...IE_n$ (38) and the names and/or links and/or information that are possible, and that may be incorporated thereinto the service and/or information entry request forms $IE_1...IE_n$ (38) at the user interfaces $I_1...I_n$ (14). A particular one of the service and/or
- 30 information entry request forms $IE_1...IE_n$ (38) may hereinafter be designated as the service and/or information entry request form IE_n (38), at the particular user interface I_n (14).

- FIG. 43 shows a typical particular one of the completed service and/or information entry request forms $IF_1...IF_n$ (230), which may hereinafter be designated the completed service and/or information entry request form IF_n (230),
- 35 at a particular one of the user interfaces $I_1...I_n$ (14), which may hereinafter be designated the user interface I_n (14), having same and different ones of the typical queries $QQ_{n1}...QQ_{nm}$ (53), different ones of the typical server addresses $AQ_{n1}...AQ_{nm}$ (54), and the typical optional instructions $VJ_{n1}...VJ_{nk}$ (52). Typical same ones of the typical queries $QQ_{n1}...QQ_{nm}$ (53), are "Cat", "Dog", and "Mouse", which are different one from the other.

FIGS. 44-46 show typical ones of the user responses $UR_1 \dots UR_n$ (37), as typical service and/or information response forms $IS_1 \dots IS_n$ (39) at the user interfaces $I_1 \dots I_n$ (14), which may be communicated thereto the corresponding ones of the users $U_1 \dots U_n$ (12). A typical particular one of the user responses $UR_1 \dots UR_n$ (37), as a particular typical one of the service and/or information response forms $IS_1 \dots IS_n$ (39) at the particular one of the user interfaces $I_1 \dots I_n$ (14) may hereinafter be designated as the user response UR_n (37), as the typical service and/or information response form IS_n (39) at the user interface I_n (14).

FIGS. 44-46 also show information therein each of the typical ones of the user responses UR_n (37), as the typical service and/or information response forms IS_n (39) at the user interface I_n (14), pertaining to the "Current Group", the "Previous Group", if appropriate, the "Next Group", if appropriate, and each "Group" by alphanumerics. FIGS. 44-46 also show information therein each of the typical ones of the user responses UR_n (37), as the typical service and/or information response forms IS_n (39) at the user interfaces I_n (14), pertaining to links to additional selections, and/or links to previous selections, if appropriate, and/or links to future selections, if appropriate, that may be made by pointing to and clicking on the selections to be made.

FIGS. 44-46 show typical ones of the user responses UR_n (37), as the typical service and/or information response forms IS_n (39) at the user interface I_n (14), with reference to FIG. 43, having information and/or services therefrom the responses $R_{n1} \dots R_{nm}$ (32) incorporated therein, and incorporated thereinto Group I, Group II, and Group III, respectively.

The user U_n (12) may optionally select Group II, and/or Group III therefrom the typical one of the user response UR_n (37), as the typical service and/or information response form IS_n (39) at the user interface I_n (14) of FIG. 44, and/or Group I and/or Group III at the user interface I_n (14) of FIG. 45, and/or Group I, and/or Group II at the user interface I_n (14) of FIG. 46. The user U_n (12) may also select Group I, and/or Group II, and/or Group III by entering such into the typical one of the service and/or information entry request form IE_n (38) at the user interfaces $I_1 \dots I_n$ (14), and completing the typical completed service and/or information entry request form IF_n (230), at the user interface I_n (14) therewith the appropriate selections to be made.

The user U_n (12) may also make other selections by entering such into the typical one of the service and/or information entry request form IE_n (38) at the user interfaces $I_1 \dots I_n$ (14), and completing the typical completed service and/or information entry request form IF_n (230), at the user interface I_n (14) therewith the appropriate selections to be made, and/or by making such selections therethrough the typical ones of the user responses UR_n (37), as the typical service and/or information response forms IS_n (39) at the user interface I_n (14). The user U_n (12) may typically make selections by pointing and clicking on the appropriate selections and/or by entering the desired information. Such information may be entered by any suitable means, including but not limited to mouse, keyboard entry, audible entry, and/or other suitable means.

FIGS. 44-46 show typical ones of the user responses UR_n (37), as the typical service and/or information response forms IS_n (39) at the user interface I_n (14), having the service and/or information group G_n (35) having the

addressable query information groups $GI_{n1} \dots GI_{nz}$ (63) therein, the labelled individual information groups $LL_{n11} \dots LL_{nzu}$ (86) therein the addressable query information groups $GI_{n1} \dots GI_{nz}$ (63), the additional request links $SL_{n1} \dots SL_{nw}$ (71), the optional service and/or information entry request form IE_n (38), and other information and/or services therein, resulting from the same and different ones of the typical queries $QQ_{n1} \dots QQ_{nm}$ (53), different ones
 5 of the typical server addresses $AQ_{n1} \dots AQ_{nm}$ (54), and the typical optional instructions $VJ_{n1} \dots VJ_{nk}$ (52).

FIGS. 44-46 show typical ones of the user responses UR_n (37), as the typical service and/or information response forms IS_n (39) at the user interface I_n (14), resulting from the typical ones of the queries $QQ_{n1} \dots QQ_{nm}$ (53), "Cat", "Mouse", and "Dog", the same ones of the typical queries $QQ_{n1} \dots QQ_{n3}$ (53) and QQ_{n9} (53) being "Cat", other
 10 same ones of the typical queries QQ_{n4} (53) and QQ_{n7} (53) being "Mouse", but different from "Cat", and other same ones of the typical queries QQ_{n5} , QQ_{n6} (53), and QQ_{n8} (53) being "Dog", but different from "Cat" and/or "Mouse", the typical ones of the queries $QQ_{n1} \dots QQ_{nm}$ (53), "Cat", "Dog", and "Mouse", being different one from the other.

15 The typical same ones of the typical queries $QQ_{n1} \dots QQ_{n3}$ (53) as "Cat" are incorporated therein into the addressable query information groups GI_{n1} (63) of Group I.

The typical one of the queries QQ_{n4} (53) as "Mouse" is incorporated therein into the addressable query information groups GI_{n1} (63) of Group II. The other same ones of the typical queries QQ_{n5} and QQ_{n6} (53) as "Dog" are
 20 incorporated therein into the addressable query information groups GI_{n2} (63) of Group II.

The typical one of the queries QQ_{n7} (53) as "Mouse" is incorporated therein into the addressable query information groups GI_{n1} (63) of Group III. The typical one of the queries QQ_{n8} (53) as "Dog" is incorporated therein into the addressable query information groups GI_{n2} (63) of Group III. The typical one of the queries QQ_{n9} (53) as "Cat" is
 25 incorporated therein into the addressable query information groups GI_{n3} (63) of Group III.

FIGS. 44-46 show typical ones of the user responses UR_n (37), as the typical service and/or information response forms IS_n (39) at the user interface I_n (14), with reference to FIG. 43 having: "Search Engine Results" as "Interleave"; "URL's per Search Engine" as "10"; "URL Details" as "Summary"; "Timeout (seconds) per Search
 30 Engine" as "3"; "Page" as "1"; "Searches per Group" as "3"; and "Group" as I, II, and III, respectively, for FIGS. 44-46.

The typical optional instructions $VJ_{n1} \dots VJ_{nk}$ (52) "URL's per Search Engine" as "10" instructs the client C_n (16) and/or the server PS (18) to return the typical user response UR_n (37), as the typical service and/or information
 35 response form IS_n (39) at the user interface I_n (14) having substantially "10" ones of the typical labelled individual information groups $LL_{n11} \dots LL_{nzu}$ (86) per each one of the typical server addresses $AQ_{n1} \dots AQ_{nm}$ (54) in the typical "Current Group", retrieved therefrom the responses $R_{n1} \dots R_{nm}$ (32). In this case, the typical labelled individual information groups $LL_{n11} \dots LL_{nzu}$ (86) may be "Uniform Resource Locators", or "URL's" and/or other services and/or information associated therewith.

The typical optional instructions **VJ_{n1}...VJ_{nk} (52)** "Searches per Group" as "3" instructs the client **C_n (16)** and/or the server **PS (18)** to return the typical user response **UR_n (37)**, as the typical service and/or information response form **IS_n (39)** at the user interface **I_n (14)** having "3 Searches per Group" for the group selected, which is designated
5 in the typical optional instructions **VJ_{n1}...VJ_{nk} (52)** having "Group" as "1".

"Group I", which is the "Current Group: I", has the first three searches ("Searches per Group" designated as "3"), i.e., Search 1, Search 2, and Search 3, having the typical queries **QQ_{n1}...QQ_{n3} (53)** of "Cat", "Cat", and "Cat" and the typical server addresses **AQ_{n1}...AQ_{n3} (54)** of "WebCrawler", "Altavista", and "Lycos".

10

The "Next Group: II" and/or the "Group: III" may be selected therefrom the typical user response **UR_n (37)**, as the typical service and/or information response form **IS_n (39)** at the user interface **I_n (14)**. If the "Next Group: II" is selected, then Search 4, Search 5, and Search 6, having the typical queries **QQ_{n4}...QQ_{n6} (53)** of "Mouse", "Dog", and "Dog" and the typical server addresses **AQ_{n4}...AQ_{n6} (54)** of "Infoseek", "Excite", and "Yahoo" are selected
15 and returned as the typical service and/or information response form **IS_n (39)** at the user interface **I_n (14)**. If the "Group: III" is selected, then Search 7, Search 8, and Search 9, having the typical queries **QQ_{n7}...QQ_{n9} (53)** of "Mouse", "Dog", and "Cat" and the typical server addresses **AQ_{n7}...AQ_{n9} (54)** of "LookSmart", "HotBot", and "Dejanews" are selected and returned as the typical service and/or information response form **IS_n (39)** at the user interface **I_n (14)**.

20

The typical optional instructions **VJ_{n1}...VJ_{nk} (52)** having "URL's per Search Engine" as "10" and "Searches per Group" as "3", then returns substantially "10 URL's per Search Engine" multiplied by "3 Searches per Group", which is substantially "30 URL's per Group", and/or other services and/or information associated therewith, returned therein the "Current Group".

25

The actual number of the typical "URL's per Group" may vary from the number of the "URL's per Search Engine" multiplied by the number of the "Searches per Group", as duplicate ones of the "URL's" and/or other services and/or information associated therewith may typically be optionally discarded.

30

The typical optional instructions **VJ_{n1}...VJ_{nk} (52)** "Page" as "1" instructs the client **C_n (16)** and/or the server **PS (18)** to return the typical user response **UR_n (37)**, as the typical service and/or information response form **IS_n (39)** at the user interface **I_n (14)** having the first "10 URL's per Search Engine" which is substantially the first "30 URL's per Group", and/or other services and/or information associated therewith, therein the "Current Group".

35

The "Next Page" and/or other pages may be selected, which in this typical case may be Pages 1-25, therefrom the typical user response **UR_n (37)**, as the typical service and/or information response form **IS_n (39)** at the user interface **I_n (14)**. If the "Next Page" is selected, then the next "10 URL's per Search Engine" which is substantially the next "30 URL's per Group", and/or other services and/or information associated therewith, therein the "Current Group" are selected and returned as the typical service and/or information response form **IS_n (39)** at the user interface **I_n**

(14). If, for example, the third "Page" is selected, then the third "10 URL's per Search Engine" which is substantially the third "30 URL's per Group", and/or other services and/or information associated therewith, therein the "Current Group" are selected and returned as the typical service and/or information response form IS_n (39) at the user interface I_n (14).

5

The typical optional instructions $VJ_{n1}...VJ_{nk}$ (52) of "Search Engine Results" as "Interleave" instructs the client C_n (16) and/or the server PS (18) to return the typical user response UR_n (37), as the typical service and/or information response form IS_n (39) at the user interface I_n (14) having ones of the typical labelled individual information groups $LL_{n11}...LL_{nzu}$ (86) and/or other services and/or information associated therewith the typical queries $QQ_{n1}...QQ_{nm}$ (53) and the typical server addresses $AQ_{n1}...AQ_{nm}$ (54) in the typical "Current Group", portions of which have been retrieved therefrom the responses $R_{n1}...R_{nm}$ (32), interleaved one with the other (or alternating one with the other) therein the appropriate addressable query information groups $GI_{n1}...GI_{nz}$ (63). The "Interleaved" information and/or services may typically be incorporated therein the appropriate addressable query information groups $GI_{n1}...GI_{nz}$ (63) therein the "Current Group" in substantially the same sequence as the information and/or services are therein the responses $R_{n1}...R_{nm}$ (32) communicated therefrom the servers $S_1...S_z$ (20). However, other sorting/grouping criteria may optionally be used, as will be discussed later. In this case, the typical labelled individual information groups $LL_{n11}...LL_{nzu}$ (86) may be "Uniform Resource Locators", or "URL's" and/or other services and/or information associated therewith.

20 "Separate" may be selected therefrom the typical user response UR_n (37), as the typical service and/or information response form IS_n (39) at the user interface I_n (14), which instructs the client C_n (16) and/or the server PS (18) to return the typical user response UR_n (37), as the typical service and/or information response form IS_n (39) at the user interface I_n (14) in "Separate" groups, i.e., grouped by the typical server addresses $AQ_{n1}...AQ_{nm}$ (54) incorporated therein the appropriate addressable query information groups $GI_{n1}...GI_{nz}$ (63) therein the "Current Group".

25 The typical optional instructions $VJ_{n1}...VJ_{nk}$ (52) "URL Details" as "Summary" instruct the client C_n (16) and/or the server PS (18) to return the typical user response UR_n (37) showing the typical labelled individual information groups $LL_{n11}...LL_{nzu}$ (86) showing descriptions and/or other information and/or services, in addition to links, and/or URL's therein the typical ones of the user responses UR_n (37), as the typical service and/or information response forms IS_n (39) at the user interface I_n (14).

30 "List" may be selected therefrom the typical user response UR_n (37), as the typical service and/or information response form IS_n (39) at the user interface I_n (14), which instructs the client C_n (16) and/or the server PS (18) to return the typical user response UR_n (37), as the typical service and/or information response form IS_n (39) at the user interface I_n (14) typically showing only links to URL's and/or other links therein the typical ones of the user responses UR_n (37), as the typical service and/or information response forms IS_n (39) at the user interface I_n (14).

The "Timeout (seconds) per Search Engine" instructs the client **C_n (16)** and/or the server **PS (18)** to return the typical user response **UR_n (37)**, as the typical service and/or information response form **IS_n (39)** at the user interface **I_n (14)** within a period of less than the "Timeout (seconds) per Search Engine" specified in the typical optional instructions **VJ_{n1}...VJ_{nk} (52)**. It should be noted that response times of less than one second per search engine are typical, and response times of substantially less than one second are quite common. However, the "Timeout (seconds) per Search Engine" has been incorporated herein for the user **U₁ (12)** to specify in the event of slow ones of the responses **R_{n1}...R_{nm} (32)** from certain ones of the servers **S₁...S_z (20)**.

If the time it takes to retrieve information from certain ones of the servers **S₁...S_z (20)** having the typical ones of the queries **QQ_{n1}...QQ_{nm} (53)** at the typical ones of the server addresses **AQ_{n1}...AQ_{nm} (54)** is greater than the "Timeout" selected, then the client **C_n (16)** and/or the server **PS (18)** typically incorporate a message and/or messages, such as "No Results Found for 'Query 'x'' at 'Server Address 'y'' within 'z' seconds!" for each of the non-responding certain ones of the servers **S₁...S_z (20)**, as shown later in FIG. 44. Information and/or services only from those ones of the servers **S₁...S_z (20)** responding within the "Timeout" period are then incorporated thereinto the typical ones of the user responses **UR_n (37)**, as the typical service and/or information response forms **IS_n (39)** at the user interface **I_n (14)**.

FIG. 47 shows the typical completed service and/or information entry request form **IF_n (230)**, at the user interface **I_n (14)**, having same and different ones of the typical queries **QQ_{n1}...QQ_{nm} (53)**, different ones of the typical server addresses **AQ_{n1}...AQ_{nm} (54)**, and the typical optional instructions **VJ_{n1}...VJ_{nk} (52)**. Typical same ones of the typical queries **QQ_{n1}...QQ_{nm} (53)** are "Cat", "Dog", and "Mouse", which are different one from the other. Typical same ones of the typical server addresses **AQ_{n1}...AQ_{nm} (54)** are "HotBot", "WebCrawler", and "Dejanews", which are different one from the other, and which are also different from "Yahoo" and "LookSmart". The typical optional instructions **VJ_{n1}...VJ_{nk} (52)** have 5 "URL's per Search Engine", which instructs the client **C_n (16)** and/or the server **PS (18)** to return the typical user response **UR_n (37)**, as the typical service and/or information response form **IS_n (39)** at the user interface **I_n (14)** having 5 "URL's per Search Engine", rather than 10 "URL's per Search Engine", as instructed in FIG. 43.

FIGS. 48-50 show typical ones of the user responses **UR_n (37)**, as the typical service and/or information response forms **IS_n (39)** at the user interface **I_n (14)**, with reference to FIG. 47, having information and/or services therefrom the responses **R_{n1}...R_{nm} (32)** incorporated therein, and incorporated thereinto Group I, Group II, and Group III, respectively.

FIGS. 48-50 show typical ones of the user responses **UR_n (37)**, as the typical service and/or information response forms **IS_n (39)** at the user interface **I_n (14)**, having the service and/or information group **G_n (35)** having the addressable query information groups **GI_{n1}...GI_{nz} (63)** therein, the labelled individual information groups **LL_{n11}...LL_{nzu} (86)** therein the addressable query information groups **GI_{n1}...GI_{nz} (63)**, the additional request links **SL_{n1}...SL_{nw} (71)**, the optional service and/or information entry request form **IE_n (38)**, and other information and/or services therein, resulting from the same and different ones of the typical queries **QQ_{n1}...QQ_{nm} (53)**, and the same

and different ones of the typical server addresses $AQ_{n1} \dots AQ_{nm}$ (54), and the typical optional instructions $VJ_{n1} \dots VJ_{nk}$ (52), rather than results just from different ones of the typical server addresses $AQ_{n1} \dots AQ_{nm}$ (54) as in FIGS. 44-46.

5 FIGS. 48-50 show the typical ones of the user responses UR_n (37), as the typical service and/or information response forms IS_n (39) at the user interface I_n (14), resulting from the typical ones of the queries $QQ_{n1} \dots QQ_{nm}$ (53), “Cat”, “Dog”, and “Mouse”, the same ones of the typical queries QQ_{n1} , QQ_{n3} (53), and QQ_{n9} (53) being “Cat”, other same ones of the typical queries QQ_{n2} (53), QQ_{n5} (53), QQ_{n6} (53), and QQ_{n8} (53) being “Dog”, but different from “Cat”, and other same ones of the typical queries QQ_{n4} and QQ_{n7} (53) being “Mouse”, but different
10 from “Cat” and/or “Dog”, the typical ones of the queries $QQ_{n1} \dots QQ_{nm}$ (53), “Cat”, “Dog”, and “Mouse”, being different one from the other.

FIGS. 48-50 also show the typical ones of the user responses UR_n (37), as the typical service and/or information response forms IS_n (39) at the user interface I_n (14), resulting from the typical ones of the server addresses
15 $AQ_{n1} \dots AQ_{nm}$ (54), “HotBot”, “WebCrawler”, “Yahoo”, “LookSmart”, and “Dejanews”, the same ones of the typical server addresses AQ_{n1} and AQ_{n2} (54) being “HotBot”, other same ones of the typical server addresses $AQ_{n3} \dots AQ_{n5}$ (54), being “WebCrawler”, but different from “HotBot”, another one of the server addresses AQ_{n6} (54), being “Yahoo”, but different from “HotBot” and/or “WebCrawler”, another one of the server addresses AQ_{n7} (54), being “LookSmart”, but different from “HotBot” and/or “WebCrawler” and/or “Yahoo”, and other same ones
20 of the typical server addresses AQ_{n8} (54) and QQ_{n9} (54) being “Dejanews”, but different from “HotBot” and/or “WebCrawler” and/or “Yahoo” and/or “LookSmart”, the typical ones of the server addresses $AQ_{n1} \dots AQ_{nm}$ (54), “HotBot”, “WebCrawler”, “Yahoo”, “LookSmart”, and “Dejanews”, being different one from the other.

The typical same ones of the typical queries QQ_{n1} and QQ_{n3} (53) as “Cat” are incorporated thereinto the
25 addressable query information groups GI_{n1} (63) of Group I. The typical one of the queries QQ_{n2} (53) as “Cat” is incorporated thereinto the addressable query information groups GI_{n2} (63) of Group II.

The typical one of the queries QQ_{n4} (53) as “Mouse” is incorporated thereinto the addressable query information groups GI_{n1} (63) of Group II. The other same ones of the typical queries QQ_{n5} and QQ_{n6} (53) as “Dog are
30 incorporated thereinto the addressable query information groups GI_{n2} (63) of Group II.

The typical one of the queries QQ_{n7} (53) as “Mouse” is incorporated thereinto the addressable query information groups GI_{n1} (63) of Group III. The typical one of the queries QQ_{n8} (53) as “Dog” is incorporated thereinto the addressable query information groups GI_{n2} (63) of Group III. The typical one of the queries QQ_{n9} (53) as “Cat” is
35 incorporated thereinto the addressable query information groups GI_{n3} (63) of Group III.

FIGS. 48-50 show typical ones of the user responses UR_n (37), as the typical service and/or information response forms IS_n (39) at the user interface I_n (14), with reference to FIG. 47 having: “Search Engine Results” as “Interleave”; “URL’s per Search Engine” as “5”; “URL Details” as “Summary”; “Timeout (seconds) per Search

Engine" as "3"; "Page" as "1"; "Searches per Group" as "5"; and "Group" as I, II, and III, respectively, for FIGS. 48-50.

Now again, FIGS. 48-50 show the typical ones of the user responses **UR_n (37)**, as the typical service and/or information response forms **IS_n (39)** at the user interface **I_n (14)**, resulting from the same and different ones of the typical queries **QQ_{n1}...QQ_{nm} (53)**, the same and different ones of the typical server addresses **AQ_{n1}...AQ_{nm} (54)**, and the typical optional instructions **VJ_{n1}...VJ_{nk} (52)**, but which also result from the typical optional instructions **VJ_{n1}...VJ_{nk} (52)** having 5 "URL's per Search Engine", which instructs the client **C_n (16)** and/or the server **PS (18)** to return the typical user response **UR_n (37)**, as the typical service and/or information response form **IS_n (39)** at the user interface **I_n (14)** having 5 "URL's per Search Engine", rather than 10 "URL's per Search Engine", as in FIGS. 44-46.

FIG. 51 shows another one of the typical completed service and/or information entry request form **IF_n (230)**, at the user interface **I_n (14)**, having the same ones of the typical queries **QQ_{n1}...QQ_{nm} (53)**, different ones of the typical server addresses **AQ_{n1}...AQ_{nm} (54)**, and the typical optional instructions **VJ_{n1}...VJ_{nk} (52)**. The typical optional instructions **VJ_{n1}...VJ_{nk} (52)** have 18 "URL's per Search Engine", which instructs the client **C_n (16)** and/or the server **PS (18)** to return the typical user response **UR_n (37)**, as the typical service and/or information response form **IS_n (39)** at the user interface **I_n (14)** having 18 "URL's per Search Engine". The typical optional instructions **VJ_{n1}...VJ_{nk} (52)** also instruct the client **C_n (16)** and/or the server **PS (18)** to return the typical user response **UR_n (37)**, as the typical service and/or information response form **IS_n (39)** at the user interface **I_n (14)** at "Group" 2, having 4 "Searches per Group", at "Page" 2 of the "Current Group", with a 2 second "Timeout (seconds) per Search Engine", and to return the results "Separately".

FIG. 52 show a typical one of the user response **UR_n (37)**, as the typical service and/or information response form **IS_n (39)** at the user interface **I_n (14)**, with reference to FIG. 51, having information and/or services therefrom the responses **R_{n1}...R_{nm} (32)** incorporated therein, and incorporated thereinto Group II.

FIG. 52 shows the typical one of the user response **UR_n (37)**, as the typical service and/or information response forms **IS_n (39)** at the user interface **I_n (14)**, with reference to FIG. 51 having: "Search Engine Results" as "Separate"; "URL's per Search Engine" as "18"; "URL Details" as "Summary"; "Timeout (seconds) per Search Engine" as "1"; "Page" as "2"; "Searches per Group" as "4"; and "Group" as "2". Groups I and/or III may be selected therefrom the typical one of the user response **UR_n (37)**, as the typical service and/or information response forms **IS_n (39)** at the user interface **I_n (14)** of FIG. 52.

FIG. 53 shows another typical completed service and/or information entry request form **IF_n (230)**, at the user interface **I_n (14)**, having same and different ones of the typical queries **QQ_{n1}...QQ_{nm} (53)**, different ones of the typical server addresses **AQ_{n1}...AQ_{nm} (54)**, and the typical optional instructions **VJ_{n1}...VJ_{nk} (52)**, with other sorting/grouping criteria selected, i.e., with Search Engine Results as "Combined \$[a-z]".

The typical optional instructions **VJ_{n1}...VJ_{nk} (52)** “Combined \$[a-z]” of FIG. 53 instructs the client **C_n (16)** and/or the server **PS (18)** to return the typical user response **UR_n (37)**, as the typical service and/or information response form **IS_n (39)** at the user interface **I_n (14)** having information and/or services therein the responses **R_{n1}...R_{nm} (32)** to be sorted in ascending order first numerically, and then alphabetically, therein the appropriate addressable query information groups **GI_{n1}...GI_{nz} (63)**. Items having prices will be sorted numerically by price, with lowest price first. The labelled individual information groups **LL_{n11}...LL_{nz_u} (86)** therein the addressable query information groups **GI_{n1}...GI_{nz} (63)** are grouped and sorted in ascending order one with the other and labelled and/or identified and associated correspondingly therewith the responses **R_{n1}...R_{nm} (32)** therefrom the servers **S₁...S_z (20)**. The “Combined \$[a-z]” information and/or services may typically be incorporated therein the appropriate addressable query information groups **GI_{n1}...GI_{nz} (63)** in accordance with the “Combined \$[a-z]” optional instructions **VJ_{n1}...VJ_{nk} (52)**, and communicated therein the other typical user response **UR_n**, as the typical service and/or information response form **IS_n** at the user interface **I_n**, which may be communicated thereto the user **U_n**, as shown in FIG. 54. However, other sorting/grouping criteria may optionally be used, as will be discussed.

FIG. 54 also depicts typical order boxes **402** of a typical order entry form **OF_n**, which is communicated therewith the typical user response **UR_n**, to enter quantities that the user **U_n** may elect to order therethrough, as the typical service and/or information response form **IS_n** at the user interface **I_n**, which may be communicated thereto the user **U_n**, which the user **U_n** may enter an order therewith.

FIG. 55 shows another typical completed service and/or information entry request form **IF_n (230)**, at the user interface **I_n (14)**, having same and different ones of the typical queries **QQ_{n1}...QQ_{nm} (53)**, different ones of the typical server addresses **AQ_{n1}...AQ_{nm} (54)**, and the typical optional instructions **VJ_{n1}...VJ_{nk} (52)**, with other sorting/grouping criteria selected, i.e., with Search Engine Results as “Combined \$[z-a]”.

The typical optional instructions **VJ_{n1}...VJ_{nk} (52)** “Combined \$[z-a]” of FIG. 55 instructs the client **C_n (16)** and/or the server **PS (18)** to return the typical user response **UR_n (37)**, as the typical service and/or information response form **IS_n (39)** at the user interface **I_n (14)** having information and/or services therein the responses **R_{n1}...R_{nm} (32)** to be sorted in descending order first alphabetically, and then numerically, therein the appropriate addressable query information groups **GI_{n1}...GI_{nz} (63)**. Items having prices will be sorted numerically by price, with highest price first. The labelled individual information groups **LL_{n11}...LL_{nz_u} (86)** therein the addressable query information groups **GI_{n1}...GI_{nz} (63)** are grouped and sorted in descending order one with the other and labelled and/or identified and associated correspondingly therewith the responses **R_{n1}...R_{nm} (32)** therefrom the servers **S₁...S_z (20)**. The “Combined \$[z-a]” information and/or services may typically be incorporated therein the appropriate addressable query information groups **GI_{n1}...GI_{nz} (63)** in accordance with the “Combined \$[z-a]” optional instructions **VJ_{n1}...VJ_{nk} (52)**, and communicated therein the other typical user response **UR_n**, as the typical service and/or information response form **IS_n** at the user interface **I_n**, which may be communicated thereto the user **U_n**, as shown in FIG. 56.

WO 01/63406

PCT/US01/05926

FIG. 57 shows another typical completed service and/or information entry request form **IF_n (230)**, at the user interface **I_n (14)**, having same and different ones of the typical queries **QQ_{n1}...QQ_{nm} (53)**, different ones of the typical server addresses **AQ_{n1}...AQ_{nm} (54)**, and the typical optional instructions **VJ_{n1}...VJ_{nk} (52)**, with other sorting/grouping criteria selected, i.e., with Search Engine Results as "Separate \$[a-z]". The typical optional instructions **VJ_{n1}...VJ_{nk} (52)** of FIG. 57 have "Separate \$[a-z]", which instructs the client **C_n (16)** and/or the server **PS (18)** to return the typical user response **UR_n (37)**, as the typical service and/or information response form **IS_n (39)** at the user interface **I_n (14)** in separate groups, sorted in ascending order first numerically, and then alphabetically, therein the appropriate addressable query information groups **GI_{n1}...GI_{nz} (63)**, i.e., grouped by the typical server addresses **AQ_{n1}...AQ_{nm} (54)**, and communicated therein the other typical user response **UR_n**, as the typical service and/or information response form **IS_n** at the user interface **I_n**, which may be communicated thereto the user **U_n**, as shown in FIG. 58. Items having prices will be sorted numerically by price, with lowest price first within each of the typical server addresses **AQ_{n1}...AQ_{nm} (54)** groups.

FIG. 59 shows another typical completed service and/or information entry request form **IF_n (230)**, at the user interface **I_n (14)**, having same and different ones of the typical queries **QQ_{n1}...QQ_{nm} (53)**, different ones of the typical server addresses **AQ_{n1}...AQ_{nm} (54)**, and the typical optional instructions **VJ_{n1}...VJ_{nk} (52)**, with other sorting/grouping criteria selected, i.e., with Search Engine Results as "Separate \$[z-a]". The typical optional instructions **VJ_{n1}...VJ_{nk} (52)** of FIG. 59 have "Separate \$[z-a]", which instructs the client **C_n (16)** and/or the server **PS (18)** to return the typical user response **UR_n (37)**, as the typical service and/or information response form **IS_n (39)** at the user interface **I_n (14)** in separate groups, sorted in descending order alphabetically, and then numerically, therein the appropriate addressable query information groups **GI_{n1}...GI_{nz} (63)**, i.e., grouped by the typical server addresses **AQ_{n1}...AQ_{nm} (54)**, and communicated therein the other typical user response **UR_n**, as the typical service and/or information response form **IS_n** at the user interface **I_n**, which may be communicated thereto the user **U_n**, as shown in FIG. 60. Items having prices will be sorted numerically by price, with highest price first within each of the typical server addresses **AQ_{n1}...AQ_{nm} (54)** groups.

FIG. 61 depicts a typical preview form of an order **OP_n**, resulting from submission of the quantities to be ordered therein order boxes **402** of the order entry form **OF_n** of FIG. 54, of the typical user response **UR_n**, as the typical service and/or information response form **IS_n** at the user interface **I_n**, which may be communicated thereto the user **U_n**, and the order entry form **OF_n**, which the user **U_n** may enter the order therewith.

FIG. 62 depicts a typical order placement form **OL_n**, having a typical preview form of the order **OP_n**, resulting from submission of the quantities to be ordered therein order boxes **402** of the order entry form **OF_n** of FIG. 54, of the typical user response **UR_n**, as the typical service and/or information response form **IS_n** at the user interface **I_n**, with the typical order information entered therein, or which the user **U_n** may enter therethrough the typical preview form of the order **OP_n** of FIG. 61.

FIG. 63 depicts a typical order confirmation **OC_n**, resulting from submission of the typical completed order placement form **OL_n** of FIG. 62.

The orders are also confirmed automatically by e-mail, with e-mailed confirmations being sent to the user U_n (12), i.e., the buyer, seller, order fulfillment organization, with the total order being totaled, portions of the order being segregated and separated one from the other, and subtotaled, each segregated and subtotaled portion being directed
5 to individual suppliers.

FIG. 64 depicts another typical service and/or information entry request form IE_n at the user interface I_n , which the user U_n may communicate other typical user input UI_n thereinto, which is substantially the same as the typical service and/or information entry request form IE_n at the user interface I_n of FIG. 53, except the typical service and/or
10 information entry request form IE_n at the user interface I_n of FIG. 64 is adapted to allow 10 different ones of the typical queries $QQ_{n1}...QQ_{nm}$ (53) and 10 different ones of the typical server addresses $AQ_{n1}...AQ_{nm}$ (54) to be entered, whereas the typical service and/or information entry request form IE_n at the user interface I_n of FIG. 53 is adapted to allow 9 different ones of the typical queries $QQ_{n1}...QQ_{nm}$ (53) and 9 different ones of the typical server addresses $AQ_{n1}...AQ_{nm}$ (54) to be entered.

15 FIG. 65 depicts another typical service and/or information entry request form IE_n at the user interface I_n , which the user U_n may communicate other typical user input UI_n thereinto, which is substantially the same as the typical service and/or information entry request form IE_n at the user interface I_n of FIG. 64, except the typical service and/or information entry request form IE_n at the user interface I_n of FIG. 65 is adapted to allow the 10 different ones of the
20 typical queries $QQ_{n1}...QQ_{nm}$ (53) and the 10 different ones of the typical server addresses $AQ_{n1}...AQ_{nm}$ (54) to be entered, aligned vertically one with the other in pairs, in two rows predominantly horizontally adjacent one with the other, whereas the typical service and/or information entry request form IE_n at the user interface I_n of FIG. 64 is adapted to allow the 10 different ones of the typical queries $QQ_{n1}...QQ_{nm}$ (53) and the 10 different ones of the typical server addresses $AQ_{n1}...AQ_{nm}$ (54) to be entered, aligned horizontally one with the other in pairs adjacent
25 one with the other in vertical rows.

FIG. 66 shows another typical completed service and/or information entry request form IF_n (230), at the user interface I_n (14), having same and different ones of the typical queries $QQ_{n1}...QQ_{nm}$ (53), different ones of the typical server addresses $AQ_{n1}...AQ_{nm}$ (54), and the typical optional instructions $VJ_{n1}...VJ_{nk}$ (52), with other
30 sorting/grouping criteria selected, i.e., with Search Engine Results as "Combined \$[a-z]".

The typical optional instructions $VJ_{n1}...VJ_{nk}$ (52) "Combined \$[a-z]" of FIG. 66 instructs the client C_n (16) and/or the server PS (18) to return the typical user response UR_n (37), as the typical service and/or information response form IS_n (39) at the user interface I_n (14) having information and/or services therein the responses $R_{n1}...R_{nm}$ (32)
35 to be sorted in ascending order first numerically, and then alphabetically, therein the appropriate addressable query information groups $GI_{n1}...GI_{nz}$ (63). Items having prices will be sorted numerically by price, with lowest price first. The labelled individual information groups $LL_{n11}...LL_{nzuz}$ (86) therein the addressable query information groups $GI_{n1}...GI_{nz}$ (63) are grouped and sorted in ascending order one with the other and labelled and/or identified and associated correspondingly therewith the responses $R_{n1}...R_{nm}$ (32) therefrom the servers $S_1...S_z$ (20). The

“Combined \$[a-z]” information and/or services may typically be incorporated therein the appropriate addressable query information groups $\mathbf{GI}_{n1} \dots \mathbf{GI}_{nz}$ (53) in accordance with the “Combined \$[a-z]” optional instructions $\mathbf{VJ}_{n1} \dots \mathbf{VJ}_{nk}$ (52), and communicated therein the other typical user response \mathbf{UR}_n , as the typical service and/or information response form \mathbf{IS}_n at the user interface \mathbf{I}_n , which may be communicated thereto the user \mathbf{U}_n , as shown in

5 FIG. 67.

FIG. 68 shows yet another typical completed service and/or information entry request form \mathbf{IF}_n (230), at the user interface \mathbf{I}_n (14), having same and different ones of the typical queries $\mathbf{QQ}_{n1} \dots \mathbf{QQ}_{nm}$ (53), different ones of the typical server addresses $\mathbf{AQ}_{n1} \dots \mathbf{AQ}_{nm}$ (54), and the typical optional instructions $\mathbf{VJ}_{n1} \dots \mathbf{VJ}_{nk}$ (52), with other

10 sorting/grouping criteria selected, i.e., with Search Engine Results as “Combined \$[a-z]”.

FIG. 68 depicts another typical service and/or information entry request form \mathbf{IE}_n at the user interface \mathbf{I}_n , which the user \mathbf{U}_n may communicate other typical user input \mathbf{UI}_n thereinto, which is substantially the same as the typical service and/or information entry request form \mathbf{IE}_n at the user interface \mathbf{I}_n of FIG. 65, except the typical service and/or

15 information entry request form \mathbf{IE}_n at the user interface \mathbf{I}_n of FIG. 68 is adapted to allow 12 different ones of the typical queries $\mathbf{QQ}_{n1} \dots \mathbf{QQ}_{nm}$ (53) and 12 different ones of the typical server addresses $\mathbf{AQ}_{n1} \dots \mathbf{AQ}_{nm}$ (54) to be entered, whereas the typical service and/or information entry request form \mathbf{IE}_n at the user interface \mathbf{I}_n of FIG. 68 is adapted to allow 10 different ones of the typical queries $\mathbf{QQ}_{n1} \dots \mathbf{QQ}_{nm}$ (53) and 10 different ones of the typical server addresses $\mathbf{AQ}_{n1} \dots \mathbf{AQ}_{nm}$ (54) to be entered.

20 FIGS. 69 and 70 depicts yet other typical service and/or information entry request forms \mathbf{IE}_n at the user interface \mathbf{I}_n , which the user \mathbf{U}_n may communicate other typical user input \mathbf{UI}_n thereinto.

Each of the typical service and/or information entry request forms \mathbf{IE}_n at the user interface \mathbf{I}_n , which the user \mathbf{U}_n may

25 communicate other typical user input \mathbf{UI}_n thereinto, of FIGS. 53-70 may also have news stories, which may be updated intermittently on a substantially routine basis.

The typical ones of the completed service and/or information entry request forms $\mathbf{IF}_1 \dots \mathbf{IF}_n$ (230) at the user interfaces $\mathbf{I}_1 \dots \mathbf{I}_n$ (14) shown in certain ones of the FIGS. 53-70 are typical examples of the completed service and/or

30 information entry request forms $\mathbf{IF}_1 \dots \mathbf{IF}_n$ (230) at the user interfaces $\mathbf{I}_1 \dots \mathbf{I}_n$ (14), a much larger variety of which is possible. Typical queries $\mathbf{QQ}_{n1} \dots \mathbf{QQ}_{nm}$ (53), typical server addresses $\mathbf{AQ}_{n1} \dots \mathbf{AQ}_{nm}$ (54), and typical optional instructions $\mathbf{VJ}_{n1} \dots \mathbf{VJ}_{nk}$ (52) therein the typical ones of the completed service and/or information entry request forms $\mathbf{IF}_1 \dots \mathbf{IF}_n$ (230) at the user interfaces $\mathbf{I}_1 \dots \mathbf{I}_n$ (14) shown in certain ones of the FIGS. 53-70 are typical examples for illustrative purposes, and are not intended to limit the substantially infinite variety of the queries

35 $\mathbf{QQ}_{n1} \dots \mathbf{QQ}_{nm}$ (53), the server addresses $\mathbf{AQ}_{n1} \dots \mathbf{AQ}_{nm}$ (54), and the optional instructions $\mathbf{VJ}_{n1} \dots \mathbf{VJ}_{nk}$ (52) that may be entered thereinto the service and/or information entry request forms $\mathbf{IE}_1 \dots \mathbf{IE}_n$ (38), to derive the completed service and/or information entry request forms $\mathbf{IF}_1 \dots \mathbf{IF}_n$ (230) at the user interfaces $\mathbf{I}_1 \dots \mathbf{I}_n$ (14). Likewise, names and/or links and/or other information are incorporated therein the typical ones of the completed service and/or information entry request forms $\mathbf{IF}_1 \dots \mathbf{IF}_n$ (230) shown in certain ones of the FIGS. 53-70 are for illustrative

purposes, and are not intended to limit the large variety of the completed service and/or information entry request forms **IF₁...IF_n (230)** and the names and/or links and/or information that are possible, and that may be incorporated thereinto the completed service and/or information entry request forms **IF₁...IF_n (230)** at the user interfaces **I₁...I_n (14)**.

5

Any ones of the typical queries **QQ_{n1}...QQ_{nm} (53)**, any values within the ranges allowable for the typical server addresses **AQ_{n1}...AQ_{nm} (54)**, and any values allowable for the typical optional instructions **VJ_{n1}...VJ_{nk} (52)** may be incorporated thereinto the typical ones of service and/or information entry request forms **IE₁...IE_n (38)** at the user interfaces **I₁...I_n (14)** shown in certain ones of the FIGS. 53-70, which the users **U₁...U_n (12)** enter to complete

10 the typical ones of the completed service and/or information entry request forms **IF₁...IF_n (230)** at the user interfaces **I₁...I_n (14)** of shown in certain ones of the FIGS. 53-70.

Any values within the ranges allowable for "Search Engine Results"; "URL's per Search Engine"; "URL Details"; "Timeout (seconds) per Search Engine"; "Page"; "Searches per Group"; and "Group" may be incorporated thereinto

15 the typical ones of service and/or information entry request forms **IE₁...IE_n (38)** at the user interfaces **I₁...I_n (14)** shown in certain ones of the FIGS. 53-70, which the users **U₁...U_n (12)** enter to complete the typical ones of the completed service and/or information entry request forms **IF₁...IF_n (230)** at the user interfaces **I₁...I_n (14)** shown in certain ones of the FIGS. 53-70.

20 The users **U₁...U_n (12)**, for example, may enter: the typical queries **QQ_{n1}...QQ_{nm} (53)**; any values within the ranges allowable for the typical server addresses **AQ_{n1}...AQ_{nm} (54)**; and any values allowable for the typical optional instructions **VJ_{n1}...VJ_{nk} (52)**, such as, for example, any allowable "Search Engine Results"; "URL's per Search Engine"; "URL Details"; "Timeout (seconds) per Search Engine"; "Page"; "Searches per Group"; and "Group" thereinto the typical ones of service and/or information entry request forms **IE₁...IE_n (38)** at the user

25 interfaces **I₁...I_n (14)** shown in certain ones of the FIGS. 53-70, which the users **U₁...U_n (12)** enter to complete the typical ones of the completed service and/or information entry request forms **IF₁...IF_n (230)** at the user interfaces **I₁...I_n (14)**. The typical ones of the user responses **UR₁...UR_n (37)**, as typical service and/or information response forms **IS₁...IS_n (39)** at the user interfaces **I₁...I_n (14)**, may then be communicated thereto the corresponding ones of the users **U₁...U_n (12)**, accordingly. Certain ones of the FIGS. 53-70 show typical ones of the user responses

30 **UR₁...UR_n (37)**, as the typical service and/or information response forms **IS₁...IS_n (39)** at the user interfaces **I₁...I_n (14)**, which may be communicated thereto the corresponding ones of the users **U₁...U_n (12)**. The scope of the client-server multitasking system **10** of the present invention, the client-server multitasking process **99**, and the multitasking process **104**, however, is not limited to such values. Use of such values herein is meant only for illustrative purposes, in teaching certain aspects of the multitasking system **10** of the present invention, the client-

35 server multitasking process **99**, and the multitasking process **104** by example.

N. ADDITIONAL FEATURES AND/OR OTHER CONSIDERATIONS

The present invention is directed to a client-server multitasking system and process capable of information and/or service retrieval from the same and/or different ones of servers substantially simultaneously and on-the-fly, using the same and/or different ones of queries of the same and/or different ones of the servers, and sorting, grouping, and/or organizing responses therefrom substantially on-the-fly, and communicating service and/or information responses to the requestors and/or users substantially simultaneously and on-the-fly. The client-server multitasking system and process is capable of use on a variety of networks, such as global area networks, and in particular the internet, metropolitan area networks, wide area networks, and local area networks, and be capable of searching search engines and/or other sites substantially simultaneously and on-the-fly.

10

The client-server multitasking system and process is capable of retrieving substantially multiple simultaneous services and/or information having the same and/or different criteria from the same and/or different servers, sorting, grouping, and/or organizing the responses from the servers and/or the clients into information and/or services responses, and communicating the service and/or information responses to the requestors and/or users substantially simultaneously. The requestors and/or the users may make substantially simultaneous service and/or information requests of servers and clients, using the same and/or different queries, and/or the same and/or different instructions. The same and/or different uniform resource locators, target resources, and/or paths may be used.

The client-server multitasking system and process is capable of making multiple substantially simultaneous same and/or different requests of same and/or different servers, organizing responses from the servers into service and/or information responses, and communicating the service and/or information responses to the requestors and/or the users substantially simultaneously.

The client-server multitasking system and process is also capable of sorting, grouping, and/or organizing results therefrom the servers, search engines, and/or sites, in accordance with instructions from the requestors, and/or the users, and/or instructions resident within the client-server multitasking system and/or process. The client-server multitasking system is capable of use in a variety of applications, and is capable of information comparison and/or trend analysis of information from the same and/or different sources substantially simultaneously. The client-server multitasking system and process is also be capable of building a client-server multitasking system search engine and/or database therefrom responses returned from the servers, search engines, and/or sites being queried and/or searched, and/or having requests made thereof, be capable of being searched and/or queried, querying sites referenced therein the client-server multitasking system search engine and/or database, and updating information and/or services stored therein.

The client-server multitasking system and process are capable of information and/or service retrieval from the same and/or different ones of servers substantially simultaneously and on-the-fly, using the same and/or different ones of queries, and sorting, grouping, and/or organizing responses therefrom substantially on-the-fly.

A requestor and/or user is capable of making substantially multiple simultaneous same and/or different requests of same and/or different servers. The client server-multitasking system and process is capable of organizing responses

WO 01/63406

PCT/US01/05926

from the servers into service and/or information responses, and communicating the service and/or information responses to the requestors and/or the users substantially simultaneously, and on-the-fly.

5 The requestors and/or users are capable of making substantially simultaneous service and/or information requests of the same and/or different ones of servers and/or clients, using the same and/or different queries, and/or the same and/or different instructions. The client-server multitasking system and process is capable of retrieving substantially multiple simultaneous services and/or information having the same and/or different criteria from the same and/or different servers, sorting, grouping, and/or organizing the responses from the servers and/or the clients into information and/or services responses, and communicating the service and/or information responses to the requestors
10 and/or the users substantially simultaneously. The same and/or different ones of uniform resource locators, target resources, and/or paths may be used.

The requestors and/or users are capable of making multiple simultaneous searches. The searches may have at least one or a plurality of same or different queries of the same and/or different servers and/or clients. The responses from
15 the servers and/or the clients may be of being organized into the service and/or information response in a variety of formats. The responses may be sorted within the service and/or information response, such as, for example, by category, query, group, page, order of importance, ascending and/or descending order, alphabetically and/or numerically, or other characteristics, as determined by the requestor, and/or the user, and/or the client-server multitasking system, and/or the responses may be combined within the service and/or information response, such as,
20 for example, interleaving the responses one with the other, such as, for example, by order of relevance or other parameters. The responses may also be capable of being grouped by search criteria, server, order of importance, or by numerical factors such as value, price, or other numerical quantifier. For example, the responses may be presentable, for example, in ascending or descending order in interleaved format, such as top ones, twos, threes, and so on, or presentable separately to the requestor and/or the user. The order may be order of importance or relevance
25 related, or, for example, numerically valued, such as price or stock market value.

The client-server multitasking system and process is be capable of information and/or service retrieval from the same and/or different ones of the servers substantially simultaneously and on-the-fly, using the same and/or different ones of the queries, and sorting, grouping, and/or organizing responses therefrom substantially on-the-fly.
30

The client-server multitasking system and process is capable of substantially multiple simultaneous searching, using the same and/or different ones of queries of the same and/or different ones of the clients and/or servers, which may be search engines, and/or sites, and/or servers, and/or locations on the network, and additionally and/or alternatively building a client-server multitasking search engine and/or database. The client-server multitasking search engine
35 and/or database is capable of storing the information and/or services retrieved therefrom the search engines, and/or sites, and/or servers, and/or locations being queried on the network therein, and building the client-server search engine and/or database. The client-server multitasking search engine should is also capable of being queried either directly and/or in combination therewith the substantially simultaneous searching, using the same and/or different queries of the same and/or different search engines, sites, servers, and/or databases. The client-server multitasking
40 search engine and/or database should is also capable of updating information and/or services stored therein by

WO 01/63406

PCT/US01/05926

querying sites, servers, search engines, and/or databases containing information and/or services referenced in client-server multitasking search engine and/or database.

5 The client-server multitasking system and process is also capable of use on a variety of networks, such as global area networks, and in particular the internet, metropolitan area networks, wide area networks, and local area networks.

10 The client-server multitasking system and process are capable of substantially simultaneous searching of the same and/or different ones of search engines and/or sites on the network substantially on-the-fly, with the same and/or different ones of the queries, and sorting, grouping, and/or organizing responses therefrom substantially on-the-fly.

15 The client-server multitasking system and process are also capable of sorting, grouping, and/or organizing results therefrom the servers, search engines, and/or sites, in accordance with instructions from the requestors and/or the users, and/or instructions resident within the client-server multitasking system and/or process. The client-server multitasking system and process are also capable drilling down and/or up to different levels within the search engines, sites, and/or servers being queried.

The client-server multitasking system and process are capable of providing manual and/or timed updates. Such timed updates allow for motion related presentation to the requestor and/or the user.

20 The client-server multitasking system and process are capable of incorporating information and/or services thereinto a variety of user interfaces at different locations therein the user interfaces, grouping, and/or organizing the information and/or services, and optionally eliminating duplicate information and/or services.

25 The client-server multitasking system and process are capable of incorporating links, graphics, video, text, and audio, and/or combinations thereof, and selective advertising, according to selectable search, query, sorting, and/or grouping criteria, and/or combinations thereof thereinto the information and/or services to be delivered thereto the user interfaces. The requestor and/or the user may place orders, such as purchases, and/or other types of orders, payments, confirmations thereof, and/or combinations thereof, either directly and/or therethrough servers and/or sites thereon the network.

30 The client-server multitasking system is capable of use in a variety of applications, and is capable of information comparison and/or trend analysis of information from the same and/or different sources substantially simultaneously. The client-server multitasking system is capable of, for example, determining best query results, with respect to a plurality of search engine results; purchasing and/or price comparisons, viewing and/or reviewing prices/values and trends for different sites, determining lowest costs and lowest cost analyses for wholesale and retail purposes; 35 product availability, e.g., airline tickets, pricing, and ticket availability, from different airlines to the same and/or different locations; purchasing of commodities and/or stocks from the same and/or different sites with updates every few seconds and/or minutes; obtaining prices and/or values in different stock markets substantially simultaneously; and searching for jobs on the same and/or different job sites, using the same and/or different job criteria, for 40 example, on a daily basis, the job sites having changing job availability; and/or a combination thereof, all

substantially simultaneously. The client-server multitasking system is capable of presenting information and/or services for review and/or updating from the same and/or different ones of sites, servers, and/or applications substantially simultaneously, and trend analysis thereof, using a variety of sorting, grouping and/or organizing criteria, according to the needs of the requestor, and/or the user, and/or resident within the client-server multitasking
5 system.

The client server-multitasking system and process are capable of service and/or information retrieval from at least one server, organization, communication, and presentation of such services and/or information to at least one requestor and/or user, and/or optional storage, and/or retrieval of such services and/or information from the optional
10 storage. The client-server multitasking system and process are capable of building a client-server multitasking system search engine and/or database therefrom responses returned from the servers, search engines, and/or sites being queried and/or searched, and/or having requests made thereof. The client-server multitasking system search engine and/or database having stored information and/or services therein are also searchable, are capable of full text searches thereof, and are searchable by the servers and/or the clients on the network, either separately and/or in
15 combination therewith the substantially simultaneous multiple same and/or different searches and/or queries of the same and/or different servers on the network. Information therein the client-server multitasking system search engine and/or database are also searchable and/or retrievable, and are capable of being incorporated therein the service and/or information responses delivered thereto the user interfaces, according to search criteria, selectively and/or automatically, by the requestor and/or the user. The client-server multitasking system search engine and/or
20 database are capable of spidering, and/or roboting, and/or querying sites, services and/or information to be stored therein and/or stored therein the client-server multitasking system search engine and/or database, and updating the services and/or information to be stored and/or stored therein the client-server multitasking system search engine and/or database.

The client-server multitasking system and process, then, are capable of information and/or service retrieval from the same and/or different ones of servers substantially simultaneously and on-the-fly, using the same and/or different ones of queries of the same and/or different ones of the servers, and sorting, grouping, and/or organizing responses therefrom substantially on-the-fly, and communicating service and/or information responses to the requestors and/or users substantially simultaneously and on-the-fly. The client-server multitasking system and process are capable of
30 use on a variety of networks, such as global area networks, and in particular the internet, metropolitan area networks, wide area networks, and local area networks, and are capable of searching search engines and/or other sites substantially simultaneously and on-the-fly. The client-server multitasking system and process are capable of sorting, grouping, and/or organizing results therefrom the servers, search engines, and/or sites, in accordance with instructions from the requestors, and/or users, and/or instructions resident within the client-server multitasking
35 system and/or process. The client-server multitasking system are capable of use in a variety of applications, and capable of information comparison and/or trend analysis of information from the same and/or different sources substantially simultaneously. The client-server multitasking system and process are capable of building a client-server multitasking system search engine and/or database therefrom responses returned from the servers, search engines, and/or sites being queried and/or searched, and/or having requests made thereof, is capable of being

searched and/or queried, querying sites referenced therein the client-server multitasking system search engine and/or database, and updating information and/or services stored therein.

The client-server multitasking system and process are capable of retrieving, parsing, processing, formatting,
 5 organizing, grouping, sorting, and consolidating services and/or information therefrom the same and/or different ones of the servers and/or clients having the same and/or different structures, formats, organizations, groupings, and/or data structures, and incorporating the parsed, processed, formatted, organized, grouped, sorted, and consolidated services and/or information thereinto user responses for delivery to and use by the requestors and/or users.

10

The client-server multitasking system **10** of the present invention, the client-server multitasking process **99**, and the multitasking process **104**, the server **PS (18)** and/or the clients **C₁...C_n (16)**, then, are capable of retrieving, parsing, processing, formatting, organizing, grouping, sorting, and consolidating services and/or information therefrom the same and/or different ones of the servers **S₁...S_z (20)**, and/or the optional servers **SO₁...SO_p (22)**,
 15 and/or the clients **C₁...C_n (16)**, having the same and/or different structures, formats, organizations, groupings, and/or data structures, and incorporating the parsed, processed, formatted, organized, grouped, sorted, and consolidated services and/or information thereinto the user responses **UR₁...UR_n (37)** for delivery to the user interfaces **I₁...I_n (14)** and use by the users **U₁...U_n (12)**.

20 The client-server multitasking system **10** of the present invention, the client-server multitasking process **99**, and the multitasking process **104**, which in itself is a process, the user interfaces **I₁...I_n (14)**, and/or the clients **C₁...C_n (16)**, and/or the server **PS (18)**, and/or the servers **S₁...S_z (20)**, and/or the optional servers **SO₁...SO_p (22)** may be constructed of hardware, firmware, software, machines, and/or operating systems, and/or combinations thereof, and/or other suitable means, and/or other components and/or systems, and/or combinations thereof. Such hardware,
 25 firmware, software, machines, and/or operating systems, and/or combinations thereof, other components and/or systems, and/or other suitable means, and/or combinations thereof may have therein and/or be resident therein, but are not limited to computer components and/or systems, television and/or telecommunications components and/or systems, merger of television and computer systems, and/or merger of television and/or computer and/or telecommunications systems, networks, simulators, interactive technologies and/or systems, cybernetics and/or
 30 cybernetic systems, and/or combinations thereof.

The clients **C₁...C_n (16)**, the server **PS (18)**, the servers **S₁...S_z (20)**, and/or the optional servers **SO₁...SO_p (22)** may be search engines, and/or sites, and/or servers, and/or clients, and/or URL's, and/or databases, and/or locations on the network, and/or other suitable components and/or systems, and/or other suitable means, and/or combinations thereof, which may be capable of communicating on the network **24**. The scope of the client-server multitasking
 35 system **10** of the present invention, the client-server multitasking process **99**, and the multitasking process **104**, however, is not limited to search engines, and/or sites, and/or servers, and/or clients, and/or URL's, and/or databases, and/or locations on the network, and/or other suitable components and/or systems, and/or other suitable means, and/or combinations thereof, which may be capable of communicating on the network **24**, as it is recognized that

other components, systems, technologies, and/or operating systems exist and/or emerge that may make use of the benefits of the present invention, and are either on the horizon and/or are recognized to be forthcoming.

The client-server multitasking system **10** of the present invention, the client-server multitasking process **99**, and the multitasking process **104**, which in itself is a process, the user interfaces $I_1 \dots I_n$ (**14**), and/or the clients $C_1 \dots C_n$ (**16**), and/or the server **PS (18)**, and/or the servers $S_1 \dots S_z$ (**20**), and/or the optional servers $SO_1 \dots SO_p$ (**22**), may then be hardware, firmware, software, and/or machines, and/or operating systems, and/or other suitable means, and/or combinations thereof, and may have and/or be resident within general purpose computers, special purpose computers, televisions, computer-television combinations, telecommunications systems, networks, mergers of computer and/or television technology and/or telecommunications technology and/or network technology, media, film, entertainment, interactive technologies and/or systems, cybernetics and/or cybernetic systems and/or technology, components, and/or systems, and/or other suitable means, and/or combinations thereof, and may be integrated one with the other and/or with other components and/or systems of one another, and may each be substantially the same and/or different one from the other.

15

The client-server multitasking system **10** of the present invention, the client-server multitasking process **99**, and the multitasking process **104**, which in itself is a process, the user interfaces $I_1 \dots I_n$ (**14**), and/or the clients $C_1 \dots C_n$ (**16**), and/or the server **PS (18)**, and/or the servers $S_1 \dots S_z$ (**20**), and/or the optional servers $SO_1 \dots SO_p$ (**22**) may each have the same and/or different hardware, firmware, software, and/or ones of operating systems, and/or other suitable means, and/or combinations thereof. The optional databases **41** and/or **42** may also be hardware, firmware, software, and/or machine based, and/or other suitable means, and/or a combinations thereof, have the same and/or different ones of operating systems and/or combinations thereof, and may have memory components associated therewith.

25

The client-server multitasking system and process is capable of use on a variety of networks, such as global area networks, and in particular the internet, metropolitan area networks, wide area networks, and local area networks. Such networks may be Earth based, satellite based, and/or space based, and/or other suitable means, and/or combinations thereof.

30

The scope of the client-server multitasking system **10** of the present invention, the client-server multitasking process **99**, and the multitasking process **104**, however, is not limited to such components, systems, technologies, operating systems and/or networks, as other components, systems, technologies, and/or operating systems exist and/or emerge that may make use of the benefits of the present invention, and are either on the horizon and/or are recognized to be forthcoming.

35

Determination as to whether the server **PS (18)** performs the multitasking process **104**, and/or whether particular ones of the clients $C_1 \dots C_n$ (**16**) perform the multitasking process **104**, may optionally be made at the particular ones of the clients $C_1 \dots C_n$ (**16**) and/or the server **PS (18)**. Such determination may optionally be made by the users $U_1 \dots U_n$ (**12**), and/or be based upon processing power, capabilities, and/or configurations of the particular ones of

the clients $C_1 \dots C_n$ (16), the server **PS (18)**, and the network **24** considerations (traffic, load, and/or other considerations).

The client-server multitasking search engine and/or database is capable of updating information and/or services stored therein by querying sites, servers, search engines, and/or databases containing information and/or services referenced in client-server multitasking search engine and/or database.

The client-server multitasking system and process is capable of use on a variety of networks, such as global area networks, and in particular the internet, metropolitan area networks, wide area networks, and local area networks, and is capable of searching search engines and/or other sites substantially simultaneously and on-the-fly.

The client-server multitasking system and process is capable of substantially simultaneous searching of the same and/or different ones of search engines and/or sites on the network substantially on-the-fly, with the same and/or different ones of the queries, and sorting, grouping, and/or organizing responses therefrom substantially on-the-fly.

The client-server multitasking system and process is also capable of sorting, grouping, and/or organizing results therefrom the servers, search engines, and/or sites, in accordance with instructions from the requestors, and/or instructions resident within the client-server multitasking system and/or process. The client-server multitasking system and process is also capable drilling down and/or up to different levels within the search engines, sites, and/or servers being queried.

Now again, the typical ones of the service and/or information entry request forms $IE_1 \dots IE_n$ (38) at the user interfaces $I_1 \dots I_n$ (14) shown in FIGS. 1-70 are typical examples of the service and/or information entry request forms $IE_1 \dots IE_n$ (38) at the user interfaces $I_1 \dots I_n$ (14), a much larger variety of which is possible. Names and/or links and/or other information are incorporated therein the typical ones of the service and/or information entry request forms $IE_1 \dots IE_n$ (38) shown in FIGS. 1-70 for illustrative purposes, and are not intended to limit the large variety of the service and/or information entry request forms $IE_1 \dots IE_n$ (38) and the names and/or links and/or information that are possible, and that may be incorporated thereinto the service and/or information entry request forms $IE_1 \dots IE_n$ (38) at the user interfaces $I_1 \dots I_n$ (14).

Now again, The typical ones of the completed service and/or information entry request forms $IF_1 \dots IF_n$ (230) at the user interfaces $I_1 \dots I_n$ (14) are typical examples of the completed service and/or information entry request forms $IF_1 \dots IF_n$ (230) at the user interfaces $I_1 \dots I_n$ (14), a much larger variety of which is possible. Typical queries $QQ_{n1} \dots QQ_{nm}$ (53), typical server addresses $AQ_{n1} \dots AQ_{nm}$ (54), and typical optional instructions $VJ_{n1} \dots VJ_{nk}$ (52) therein the typical ones of the completed service and/or information entry request forms $IF_1 \dots IF_n$ (230) at the user interfaces $I_1 \dots I_n$ (14) shown in FIGS. 1-70 are typical examples for illustrative purposes, and are not intended to limit the substantially infinite variety of the queries $QQ_{n1} \dots QQ_{nm}$ (53), the server addresses $AQ_{n1} \dots AQ_{nm}$ (54), and the optional instructions $VJ_{n1} \dots VJ_{nk}$ (52) that may be entered thereinto the service and/or information entry request forms $IE_1 \dots IE_n$ (38), to derive the completed service and/or information entry request forms $IF_1 \dots IF_n$ (230) at the user interfaces $I_1 \dots I_n$ (14). Likewise, names and/or links and/or other information are incorporated

therein the typical ones of the completed service and/or information entry request forms **IF₁...IF_n (230)** for illustrative purposes, and are not intended to limit the large variety of the completed service and/or information entry request forms **IF₁...IF_n (230)** and the names and/or links and/or information that are possible, and that may be incorporated therein the completed service and/or information entry request forms **IF₁...IF_n (230)** at the user
5 interfaces **I₁...I_n (14)**.

Now again, the typical ones of the user responses **UR₁...UR_n (37)**, as typical service and/or information response forms **IS₁...IS_n (39)** at the user interfaces **I₁...I_n (14)** are typical examples of the user responses **UR₁...UR_n (37)**, as typical service and/or information response forms **IS₁...IS_n (39)** at the user interfaces **I₁...I_n (14)**, a much larger
10 variety of which is possible. Certain ones of FIGS. 1-70 illustrate typical examples of typical ones of the user responses **UR₁...UR_n (37)**, as typical service and/or information response forms **IS₁...IS_n (39)** at the user interfaces **I₁...I_n (14)** to the typical queries **QQ_{n1}...QQ_{nm} (53)**, the typical ones of the server addresses **AQ_{n1}...AQ_{nm} (54)**, and the typical optional instructions **VJ_{n1}...VJ_{nk} (52)** having been entered therein the typical ones of the completed service and/or information entry request forms **IF₁...IF_n (230)** at the user interfaces
15 **I₁...I_n (14)**.

The typical examples of the typical ones of the user responses **UR₁...UR_n (37)**, as typical service and/or information response forms **IS₁...IS_n (39)** at the user interfaces **I₁...I_n (14)** are for illustrative purposes, and are not intended to limit the substantially infinite variety of the user responses **UR₁...UR_n (37)**, as the service and/or information
20 response forms **IS₁...IS_n (39)** at the user interfaces **I₁...I_n (14)**, the queries **QQ_{n1}...QQ_{nm} (53)**, the server addresses **AQ_{n1}...AQ_{nm} (54)**, and the optional instructions **VJ_{n1}...VJ_{nk} (52)** that may be entered therein the service and/or information entry request forms **IE₁...IE_n (38)**, to derive the to the completed service and/or information entry request forms **IF₁...IF_n (230)**, and which result in the user responses **UR₁...UR_n (37)**, as the service and/or information response forms **IS₁...IS_n (39)** at the user interfaces **I₁...I_n (14)**. Likewise, names and/or links and/or
25 other information are incorporated therein the typical ones of the user responses **UR₁...UR_n (37)**, as the service and/or information response forms **IS₁...IS_n (39)** at the user interfaces **I₁...I_n (14)** are shown for illustrative purposes, and are not intended to limit the large variety of the user responses **UR₁...UR_n (37)**, as the service and/or information response forms **IS₁...IS_n (39)** at the user interfaces **I₁...I_n (14)**, and the names and/or links and/or information that are possible, and that may be incorporated therein the user responses **UR₁...UR_n (37)**, as the
30 service and/or information response forms **IS₁...IS_n (39)** at the user interfaces **I₁...I_n (14)**.

The server addresses **AQ_{n1}...AQ_{nm} (54)**, such as WebCrawler, Altavista, Lycos, Infoseek, Excite, Yahoo, LookSmart, HotBot, Dejanews, Amazon, Borders, BarnesandNoble, Google, and/or others that may have been used herein are for illustrative purposes, to illustrate typical ones of the service and/or information entry request forms
35 **IE₁...IE_n (38)** at the user interfaces **I₁...I_n (14)**, typical ones of the completed service and/or information entry request forms **IF₁...IF_n (230)** at the user interfaces **I₁...I_n (14)**, and/or typical ones of the user responses **UR₁...UR_n (37)**, as the service and/or information response forms **IS₁...IS_n (39)** at the user interfaces **I₁...I_n (14)**, and other examples used herein, are used merely to illustrate typical examples of the server addresses **AQ_{n1}...AQ_{nm} (54)** and results therefrom that may be possible. The examples shown in FIGS. 1-70, and other examples used herein, are

examples of the substantially infinite variety of the server addresses **AQ_{n1}...AQ_{nm} (54)** that may be used with the client-server multitasking system **10** of the present invention and the results that may be obtained therefrom. The typical server addresses **AQ_{n1}...AQ_{nm} (54)**, such as WebCrawler, Altavista, Lycos, Infoseek, Excite, Yahoo, LookSmart, HotBot, Dejanews, Amazon, Borders, BarnesandNoble, Google, and/or others that may have been used
 5 herein are for illustrative purposes only and are not intended to limit the scope of the client-server multitasking system **10** of the present invention.

It should also be obvious that the typical queries **QQ_{n1}...QQ_{nm} (53)** used in the examples shown in FIGS. 1-70 and other examples used herein are for illustrative purposes and are merely typical examples of the substantially infinite
 10 variety of the queries **QQ_{n1}...QQ_{nm} (53)** that may be used with the client-server multitasking system **10** of the present invention and the results that may be obtained therefrom, and are not intended to limit the substantially infinite variety of the queries **QQ_{n1}...QQ_{nm} (53)** that may be used with the client-server multitasking system **10** of the present invention and the results that may be obtained therefrom. The typical queries **QQ_{n1}...QQ_{nm} (53)** used in
 15 the examples shown in FIGS. 1-70 and other examples used herein are for illustrative purposes only and are not intended to limit the scope of the client-server multitasking system **10** of the present invention.

The typical labelled individual information groups **LL_{n11}...LL_{nzu} (86)**, the typical optional links **LD_{nm1}...LD_{nmr} (82)**, and/or the typical optional descriptions **DD_{nm1}...DD_{nmr} (83)**, and/or the typical optional prices/values **PD_{nm1}...PD_{nmr} (84)**, and/or the typical optional images **ID_{nm1}...ID_{nmr} (85)**, and/or advertisements and/or
 20 advertisement links, and/or URL's, and/or locations, and/or other items and/or objects shown in FIGS. 1-70 and other examples used herein are typical examples for illustrative purposes only and are not intended to limit the scope of the client-server multitasking system **10** of the present invention. A substantially infinite variety of the labelled individual information groups **LL_{n11}...LL_{nzu} (86)**, the optional links **LD_{nm1}...LD_{nmr} (82)**, and/or the optional descriptions **DD_{nm1}...DD_{nmr} (83)**, and/or the optional prices/values **PD_{nm1}...PD_{nmr} (84)**, and/or the optional images
 25 **ID_{nm1}...ID_{nmr} (85)**, and/or advertisements and/or advertisement links, and/or URL's, and/or locations, and/or other items and/or objects may result from the substantially infinite varieties and combinations thereof of the queries **QQ_{n1}...QQ_{nm} (53)** and the substantially infinite varieties and combinations thereof of the server addresses **AQ_{n1}...AQ_{nm} (54)** of the client-server multitasking system **10** of the present invention, the client-server multitasking process **99**, and the multitasking process **104**, which in itself is a process.
 30

Likewise, the typical grouping/sorting criteria shown herein in the examples is for illustrative purposes only and is not intended to limit the scope of the client-server multitasking system **10** of the present invention. It is possible to sort the responses within the service and/or information response, such as, for example, by category, query, group, page, order of importance, ascending and/or descending order, alphabetically and/or numerically, or other
 35 characteristics, as determined by the requestor, and/or the user, and/or the client-server multitasking system, or to combine the responses within the service and/or information response, such as, for example, interleaving the responses one with the other, such as, for example, by order of relevance or other parameters. The responses then are capable of being grouped by search criteria, server, order of importance, or by numerical factors such as value, price, or other numerical quantifier. For example, the responses may be presentable, for example, in ascending or

WO 01/63406

PCT/US01/05926

descending order in interleaved format, such as top ones, twos, threes, and so on, or presentable separately to the requestor and/or the user. The order may be order of importance or relevance related, or, for example, numerically valued, such as price or stock market value. A substantially infinite variety of results may be generated from the substantially infinite variety of grouping/sorting criteria possible with the client-server multitasking system **10** of the present invention.

A substantially infinite variety of URL's, links, locations, sites, servers, and/or clients, other items and/or objects may be used with the client-server multitasking system **10** of the present invention, the client-server multitasking process **99**, and the multitasking process **104**, which in itself is a process. Examples of URL's, links, locations, sites, servers, and/or clients, other items and/or objects shown in FIGS. 1-70 are typical examples of URL's, links, locations, sites, servers, and/or clients, other items and/or objects that may be of used therewith the client-server multitasking system **10** of the present invention, the client-server multitasking process **99**, and the multitasking process **104**, and are used herein for illustrative purposes only, and are not intended to limit the scope of the client-server multitasking system **10** of the present invention, the client-server multitasking process **99**, and/or the multitasking process **104**.

A substantially infinite variety of advertisements and/or links may be used with the client-server multitasking system **10** of the present invention. The advertisements and/or links to such sites as Netscape and/or ABC News, Disney Discovery, Warner, ABC, Universal, CBS, NBC, TV Guide, NYtimes, ESPN, WSjournal, CNN, and/or other sites used in the examples shown in FIGS. 1-70 and other examples used herein are for illustrative purposes only and are not intended to limit the scope of the client-server multitasking system **10** of the present invention.

It should also be obvious that advertisements and/or links to such sites as Netscape and/or ABC News, and/or other sites that may be used herein are for illustrative purposes only and are not intended to limit the scope of the client-server multitasking system **10** of the present invention.

Each of the typical service and/or information entry request forms IE_n at the user interface I_n , which the user U_n may communicate other typical user input UI_n therinto, may also have news stories, which may be updated intermittently on a substantially routine basis.

The client-server multitasking system and process are also capable of performing as a multiple query search engine, which performs multiple queries of multiple sites, and of performing as a single point of sale for purchasing multiple products from multiple sources.

Although the present invention has been described in considerable detail with reference to certain preferred versions thereof, other versions are possible. Therefore, the spirit and scope of the appended claims should not be limited to the description of the preferred versions contained herein.

CLAIMS

What is claimed is:

- 5 1. A multitasking process comprising:
- a) parsing, processing, and/or formatting a service and/or information request thereinto a current request group;
 - b) opening connections therewith and making at least one request thereof at least one server;
 - c) parsing, processing, formatting, grouping, and/or organizing at least one response therefrom said at least
10 one server thereinto at least one addressable response information group;
 - d) formulating information therefrom said current request group thereinto a request pointer/address group having at least one pointer/address;
 - e) formulating at least one addressable query pointer/address group having at least one other
15 pointer/address;
 - f) incorporating information and/or services therefrom said at least one addressable response information group thereinto at least one addressable query information group; and
 - g) incorporating said at least one addressable query information group thereinto a service and/or information response.
- 20 2. The multitasking process of claim 1, further comprising parsing, processing, and/or formatting said service and/or information request thereinto at least one other request group.
3. The multitasking process of claim 1, further comprising parsing, processing, and/or formatting said service and/or information request thereinto at least one optional instruction.
- 25 4. The multitasking process of claim 1, further comprising directing said pointers/addresses therefrom said request pointer/address group to point/address said addressable query pointer/address groups.
5. The multitasking process of claim 4, further comprising directing said other pointers/addresses therefrom
30 said addressable query pointer/address groups to point/address information and/or services therein said addressable response information groups.
6. The multitasking process of claim 5, further comprising directing said other pointers/addresses therefrom
35 said addressable query pointer/address groups to point/address information and/or services therein said addressable response information groups based upon grouping and/or sorting criteria.
7. The multitasking process of claim 1, wherein said requests of said servers are the same and/or different one from the other.
- 40 8. The multitasking process of claim 1, wherein said servers are the same and/or different one from the other.

9. The multitasking process of claim 1, wherein said requests are the same and/or different one from the other of the same and/or different ones of said servers.
- 5 10. The multitasking process of claim 1, wherein said requests have the same and/or different ones of queries.
11. The multitasking process of claim 11, wherein said requests have the same and/or different ones of queries.
12. The multitasking process of claim 1, wherein said multitasking process is performed substantially on-the-
10 fly.
13. The multitasking process of claim 1, wherein said connections are opened substantially simultaneously and said requests are made substantially simultaneously.
- 15 14. The multitasking process of claim 1, wherein further duplicate information and/or services therein said addressable response information groups is discarded.
15. The multitasking process of claim 1, wherein information and/or services therefrom said addressable response information groups is incorporated thereinto at least one individual information group therein at
20 least one said addressable query information group.
16. The multitasking process of claim 15, wherein said individual information groups are labelled and/or identified.
- 25 17. The multitasking process of claim 16, wherein said labelled and/or identified individual information groups are alternately interleaved one with the other and labelled and/or identified and associated correspondingly therewith said responses therefrom said servers.
18. A multitasking process comprising:
- 30 a) parsing, processing, and/or formatting a service and/or information request thereinto a current request group;
- b) opening connections therewith and making at least one request thereof at least one server;
- c) parsing, processing, formatting, grouping, and/or organizing at least one response therefrom said at least one server thereinto at least one addressable response information group;
- 35 d) formulating information therefrom said current request group thereinto a request pointer/address group having at least one pointer/address;
- e) incorporating information and/or services therefrom said at least one addressable response information group thereinto at least one addressable query information group; and
- f) incorporating said at least one addressable query information group thereinto a service and/or
40 information response.

19. The multitasking process of claim 18, further comprising directing said pointers/addresses therefrom said request pointer/address group to point/address information and/or services therein said addressable response information groups.

5

20. A client-server multitasking system comprising:

a) means for parsing, processing, and/or formatting a service and/or information request thereinto a current request group;

b) means for opening connections therewith and making at least one request thereof at least one server;

10

c) means for parsing, processing, formatting, grouping, and/or organizing at least one response therefrom said at least one server thereinto at least one addressable response information group;

d) means for formulating information therefrom said current request group thereinto a request pointer/address group having at least one pointer/address;

15

e) means for formulating at least one addressable query pointer/address group having at least one other pointer/address;

f) means for incorporating information and/or services therefrom said at least one addressable response information group thereinto at least one addressable query information group; and

g) means for incorporating said at least one addressable query information group thereinto a service and/or information response.

20

21. A multitasking process comprising:

a) means for parsing, processing, and/or formatting a service and/or information request thereinto a current request group;

b) means for opening connections therewith and making at least one request thereof at least one server;

25

c) means for parsing, processing, formatting, grouping, and/or organizing at least one response therefrom said at least one server thereinto at least one addressable response information group;

d) means for formulating information therefrom said current request group thereinto a request pointer/address group having at least one pointer/address;

30

e) means for incorporating information and/or services therefrom said at least one addressable response information group thereinto at least one addressable query information group; and

f) means for incorporating said at least one addressable query information group thereinto a service and/or information response.

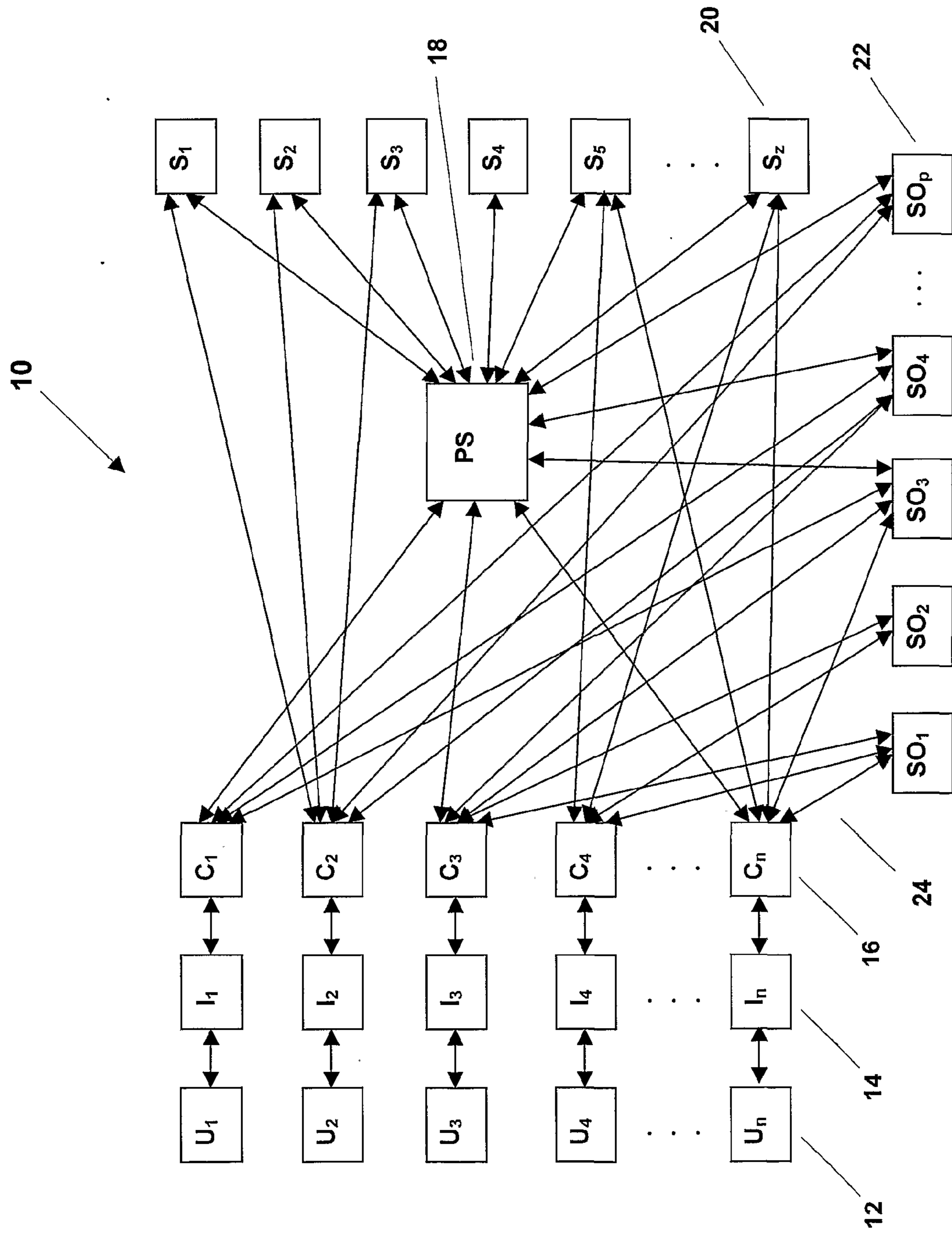

FIG. 1

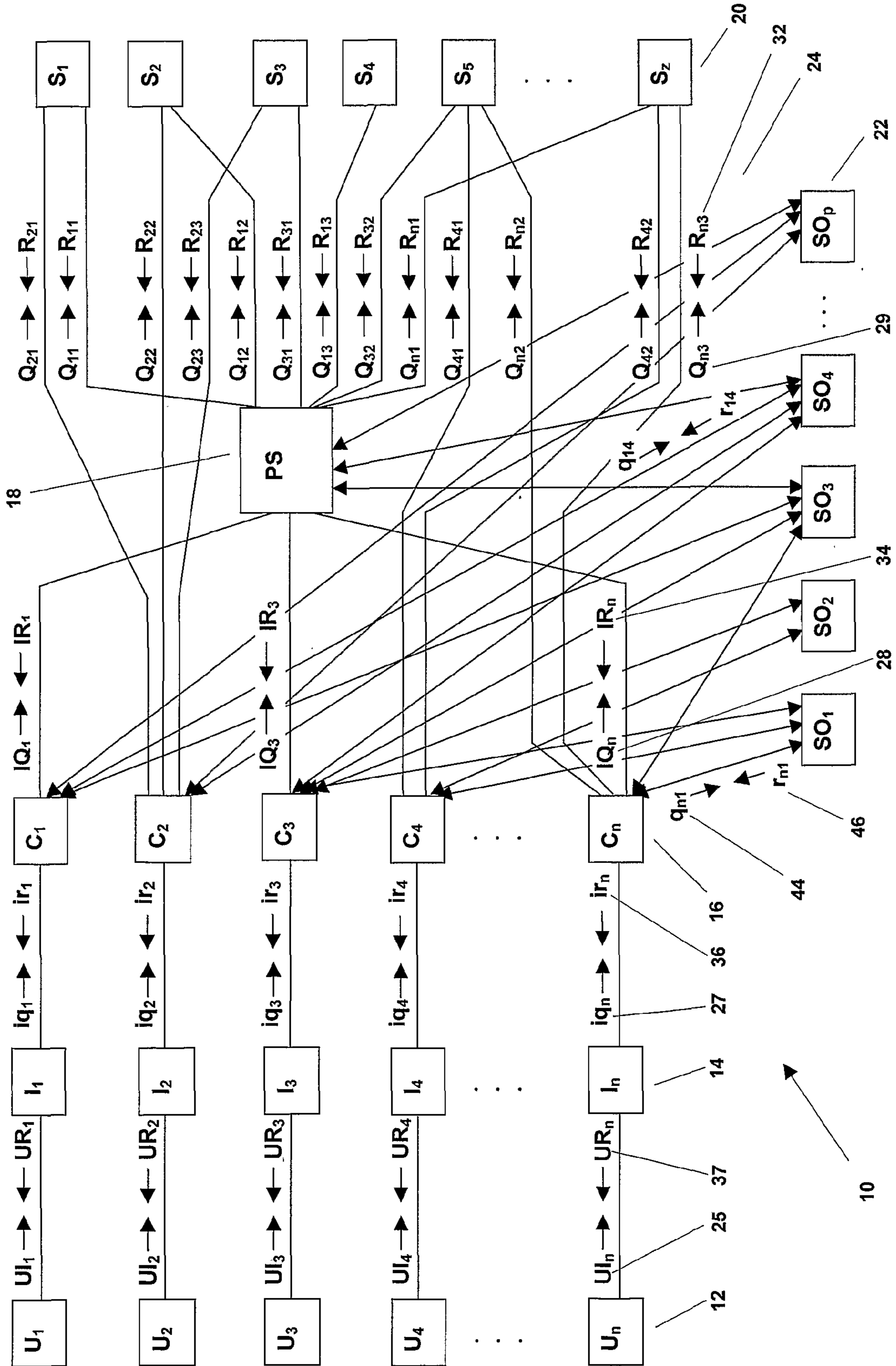

FIG. 2

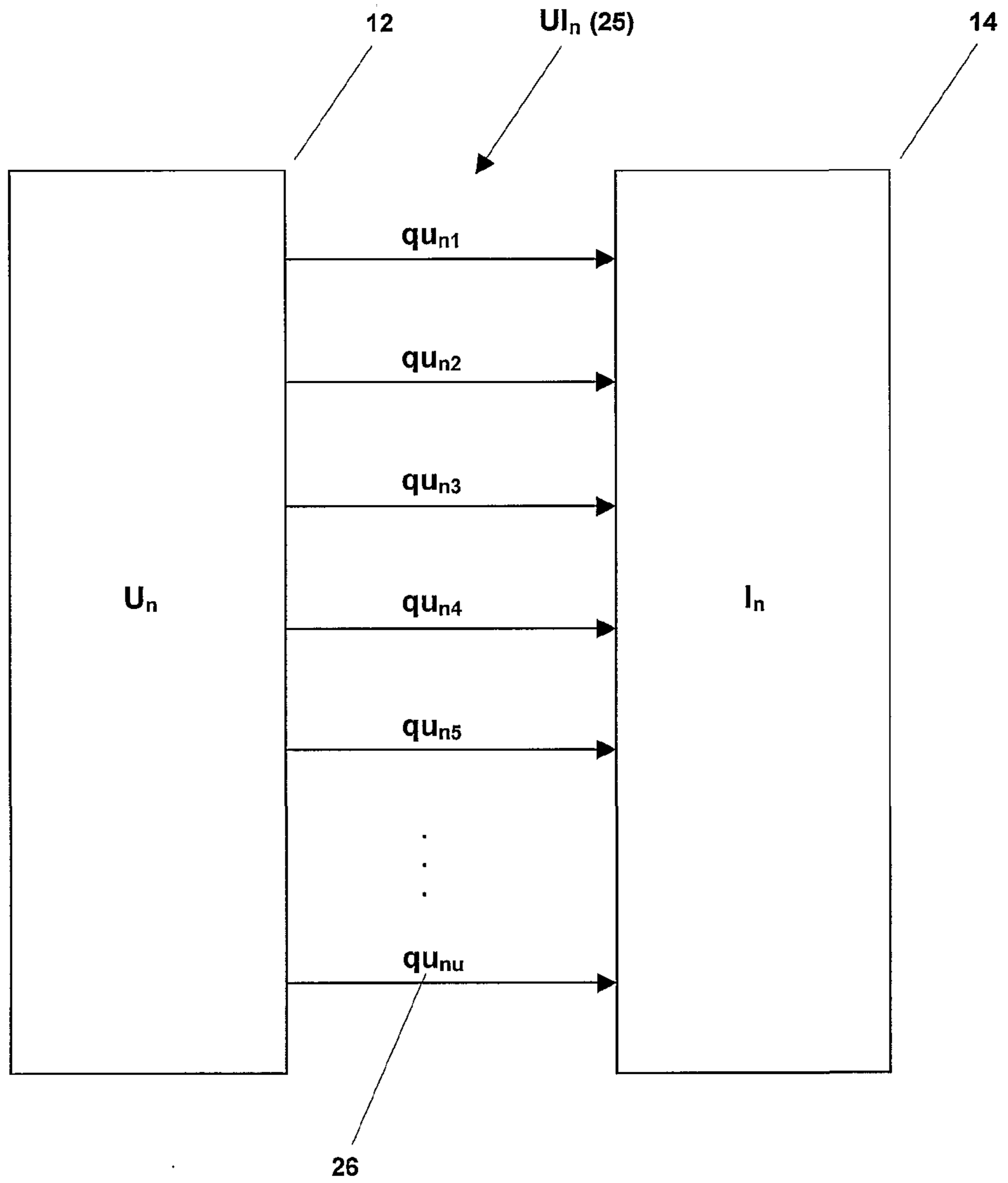

FIG. 3

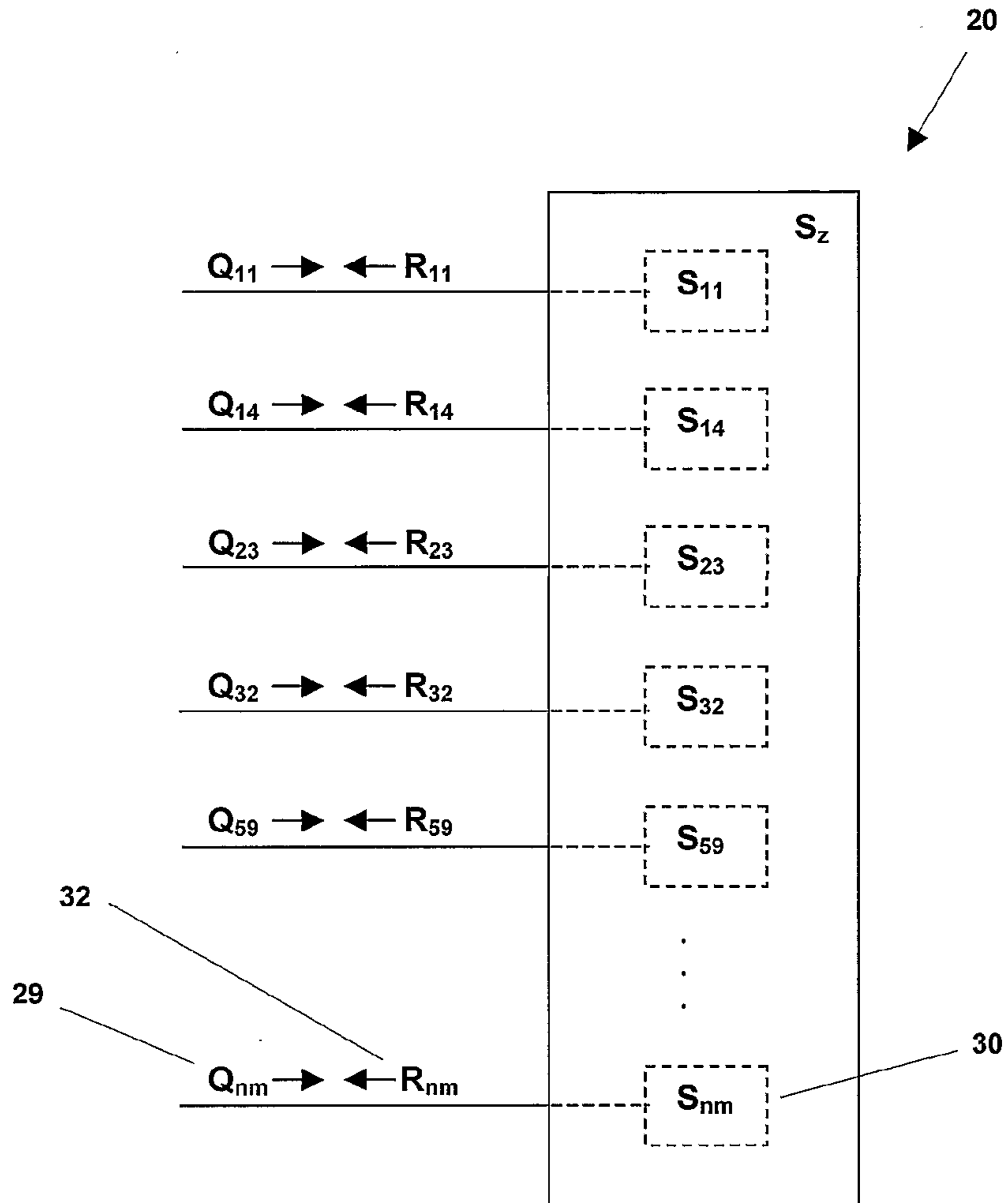

FIG. 4

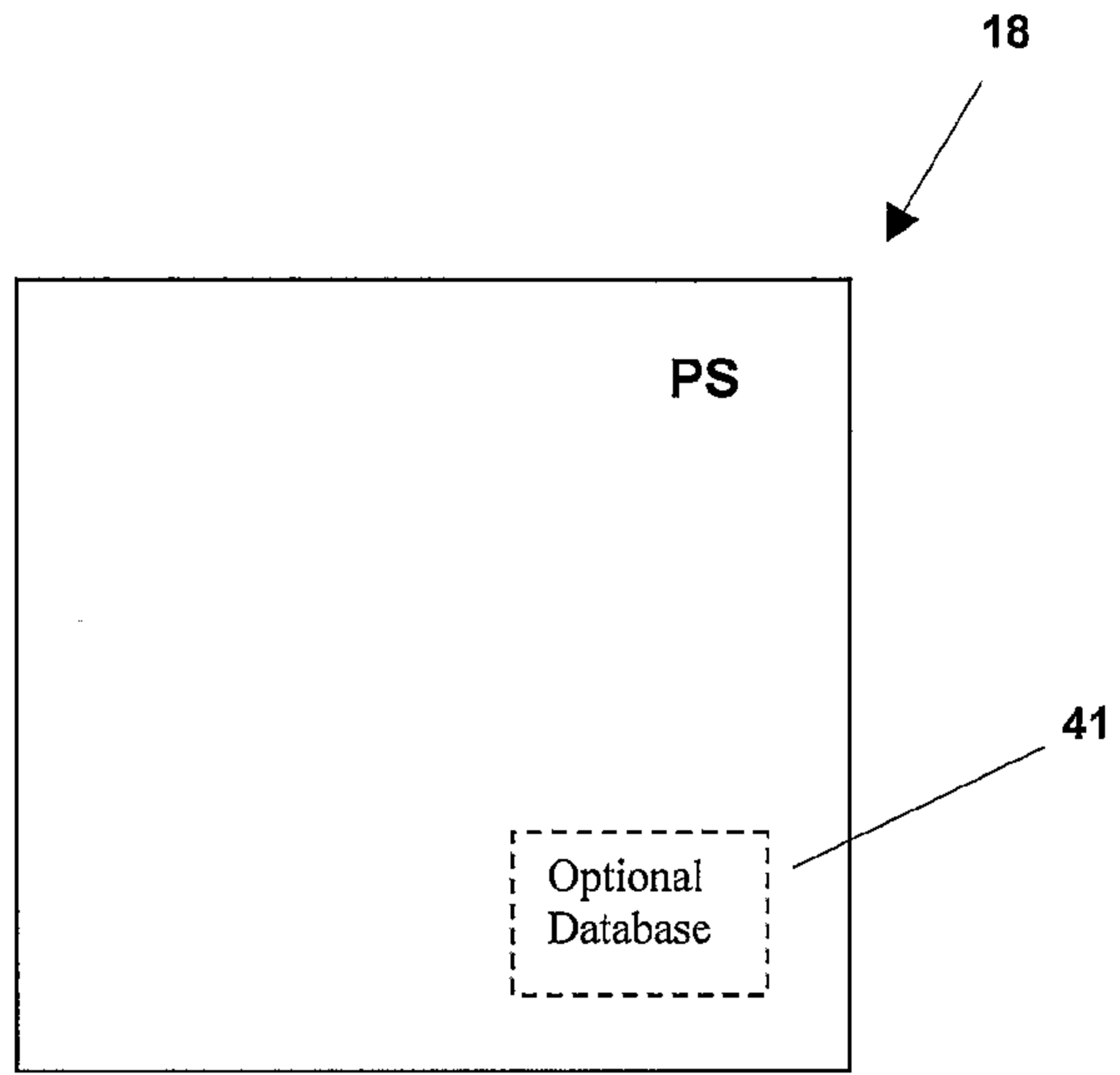

FIG. 5A

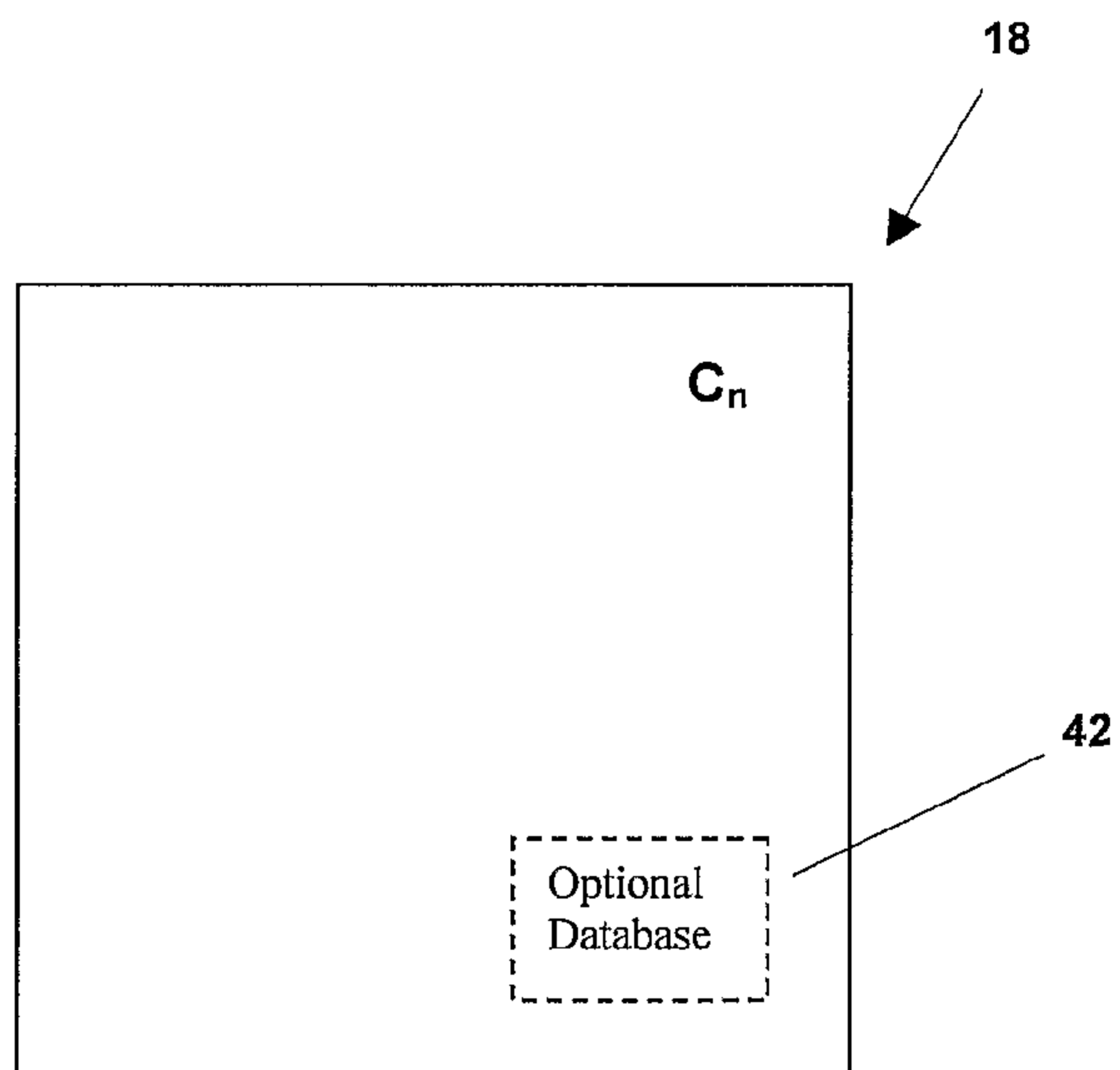

FIG. 5B

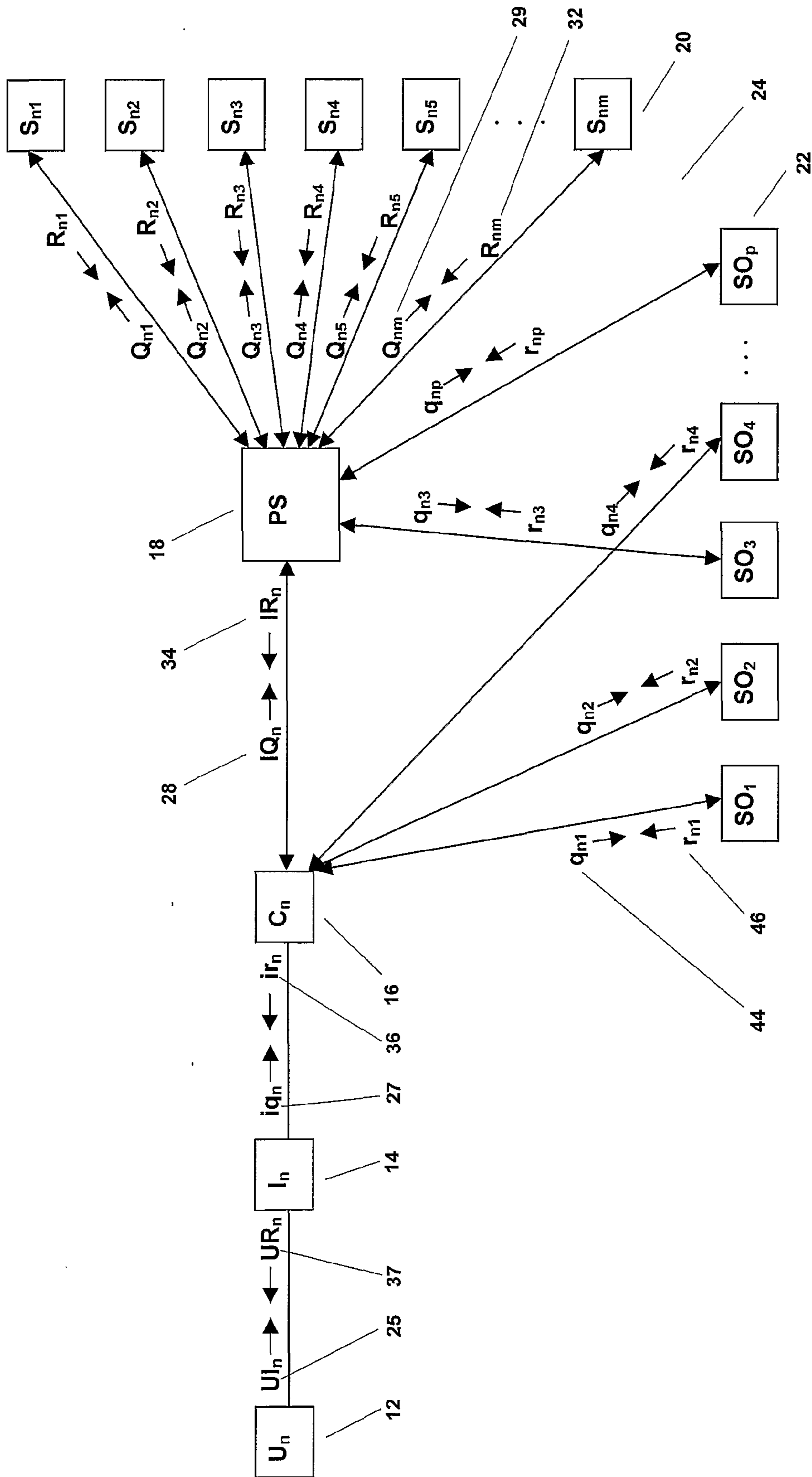

FIG. 6

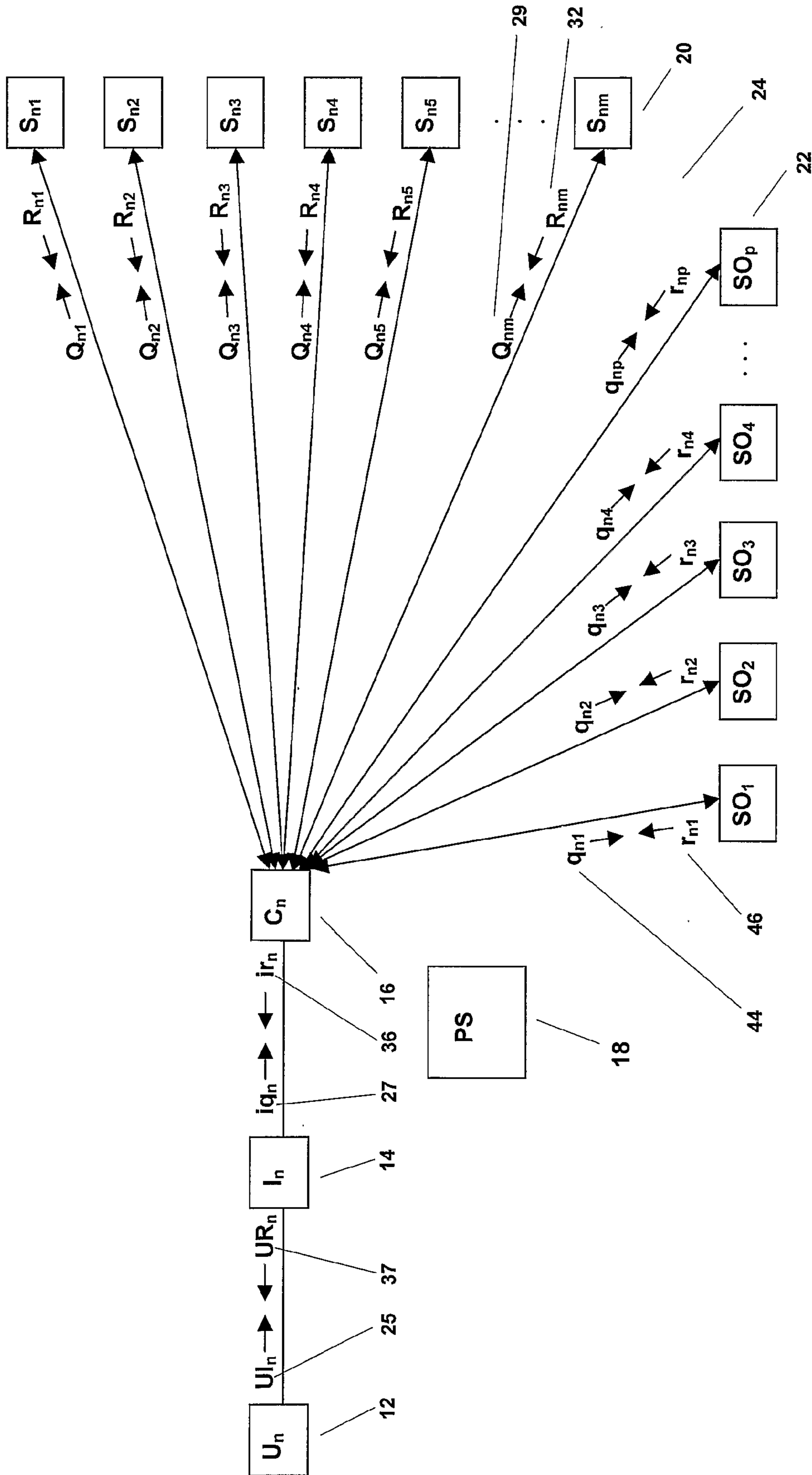

FIG. 7

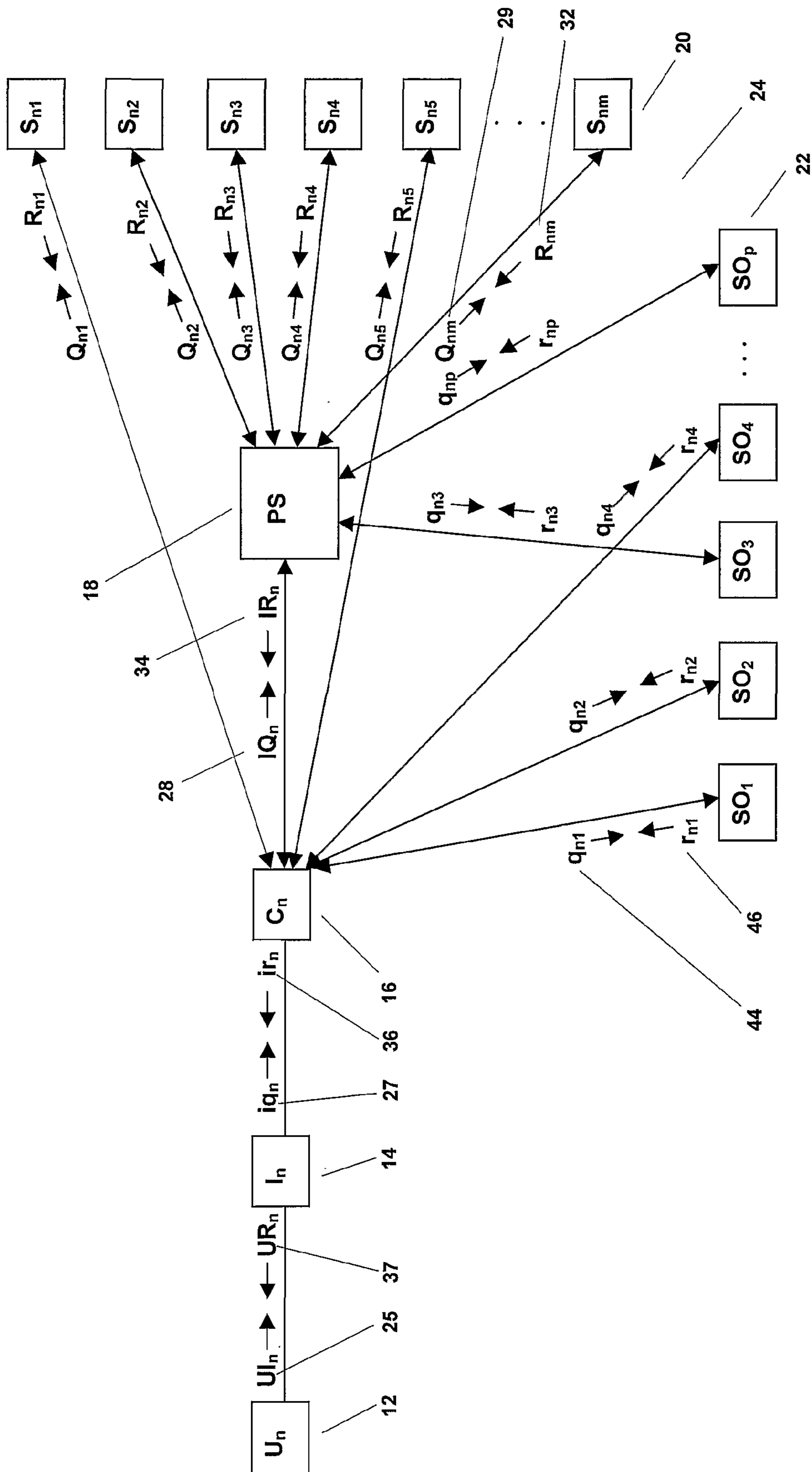

FIG. 8

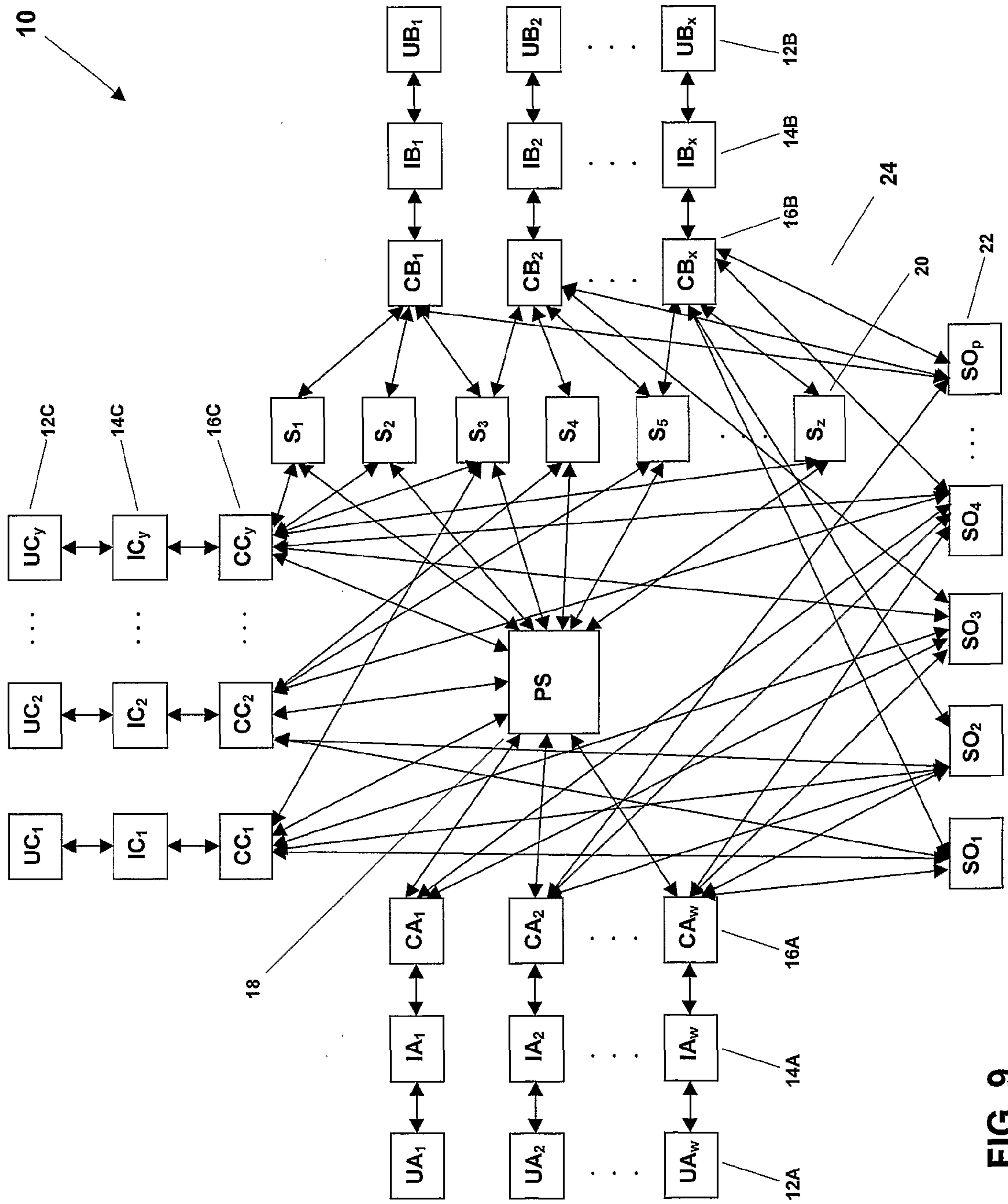

FIG. 9

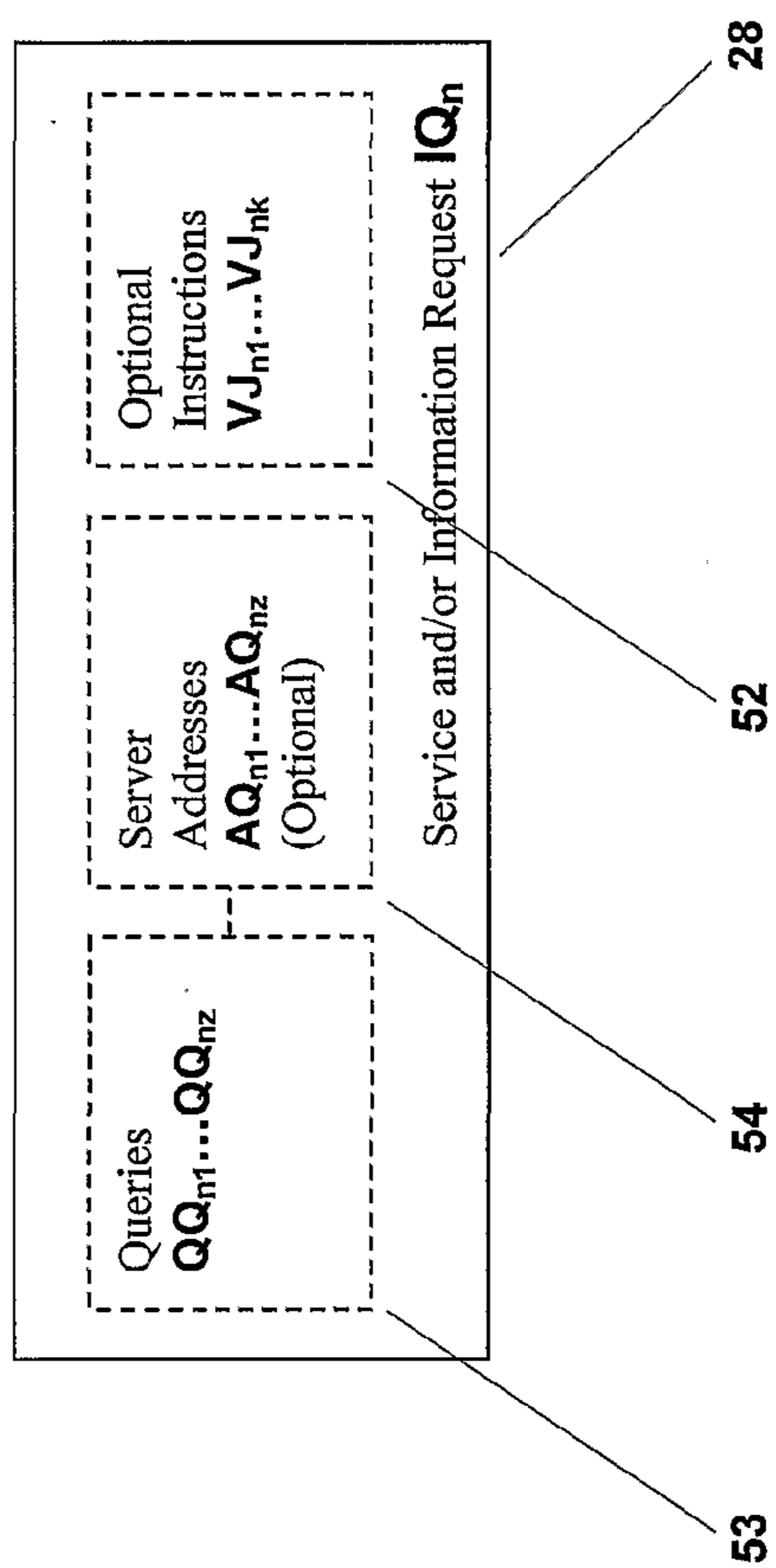

FIG. 10

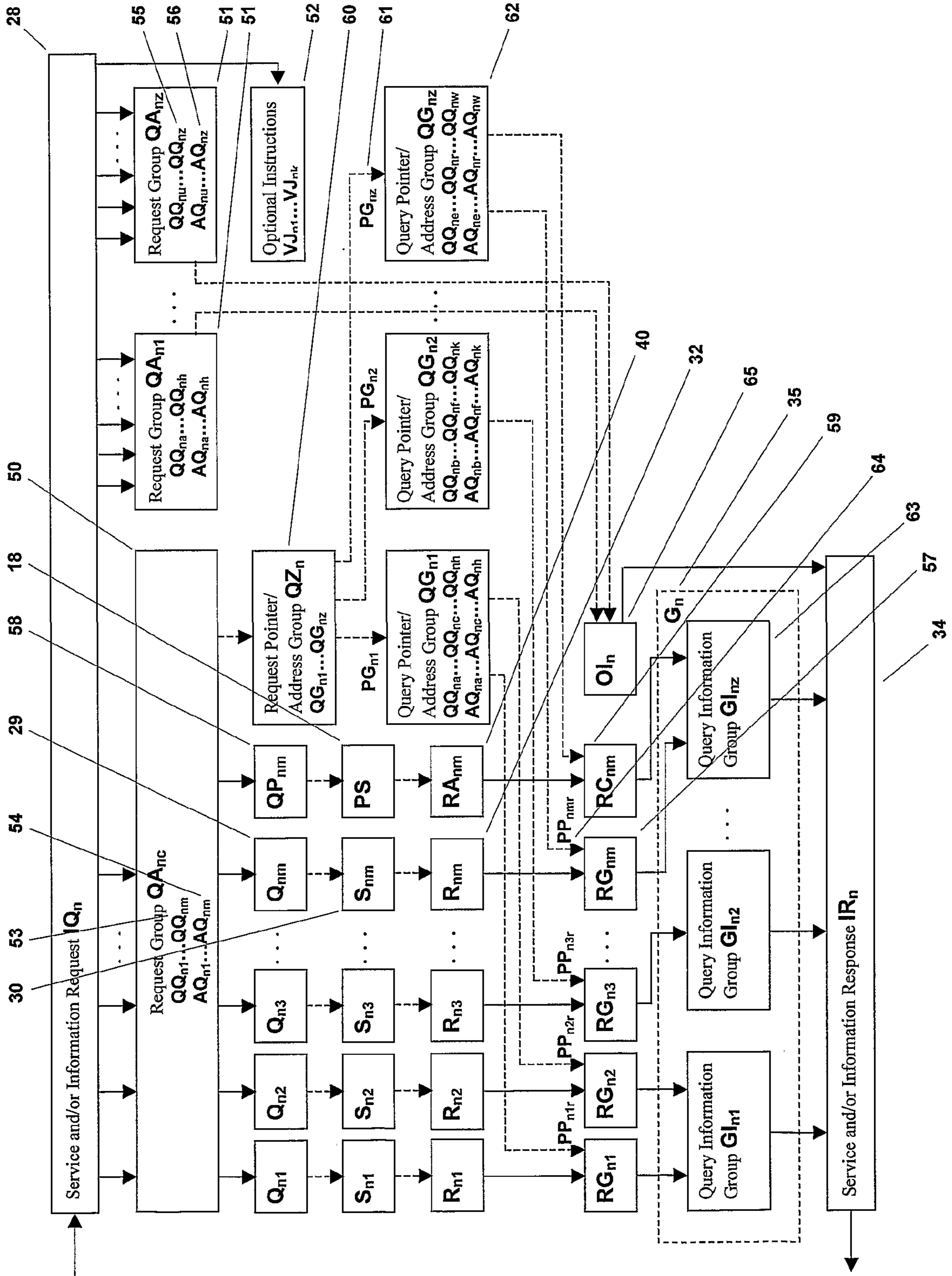

FIG. 11

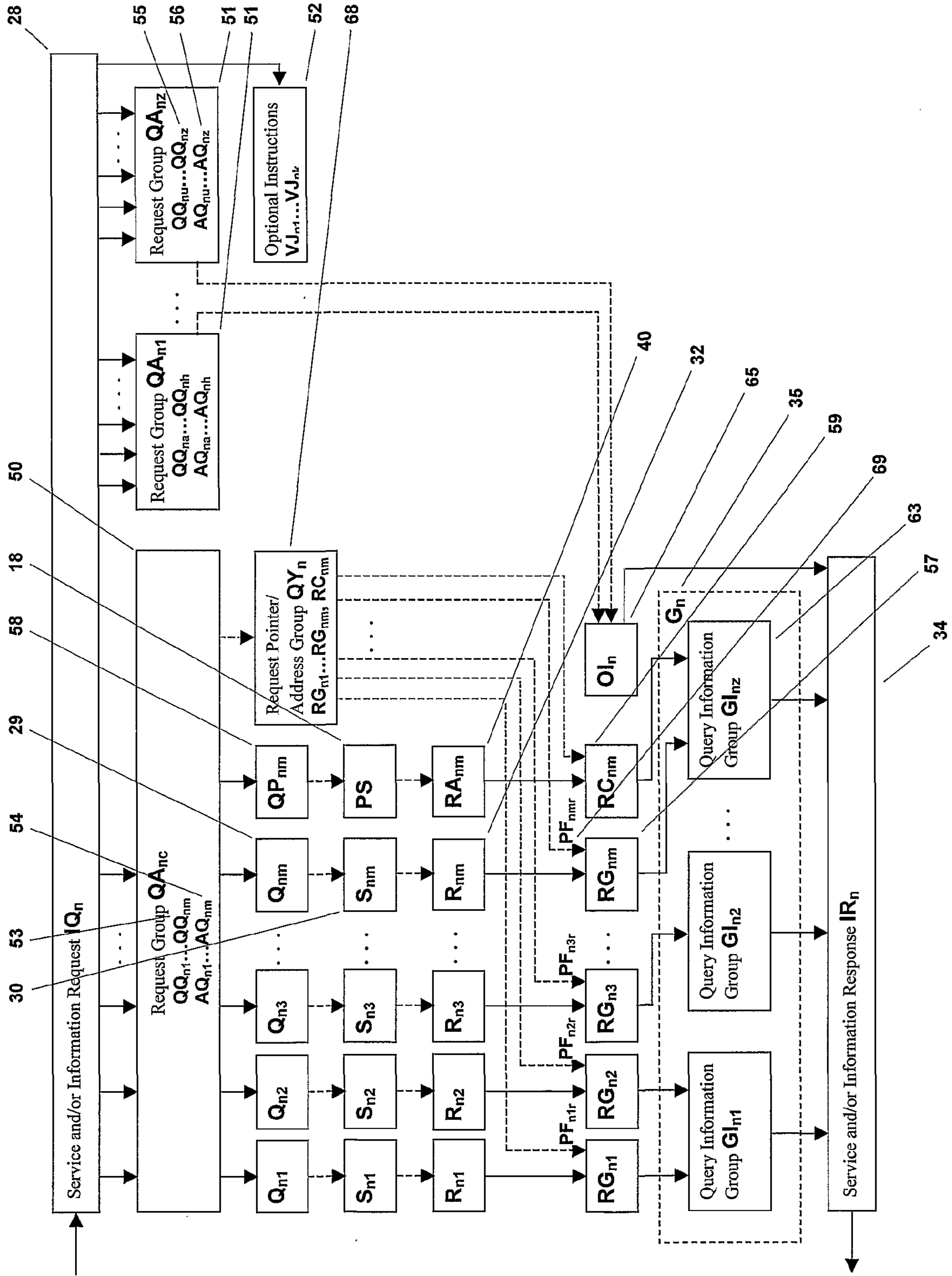

FIG. 12

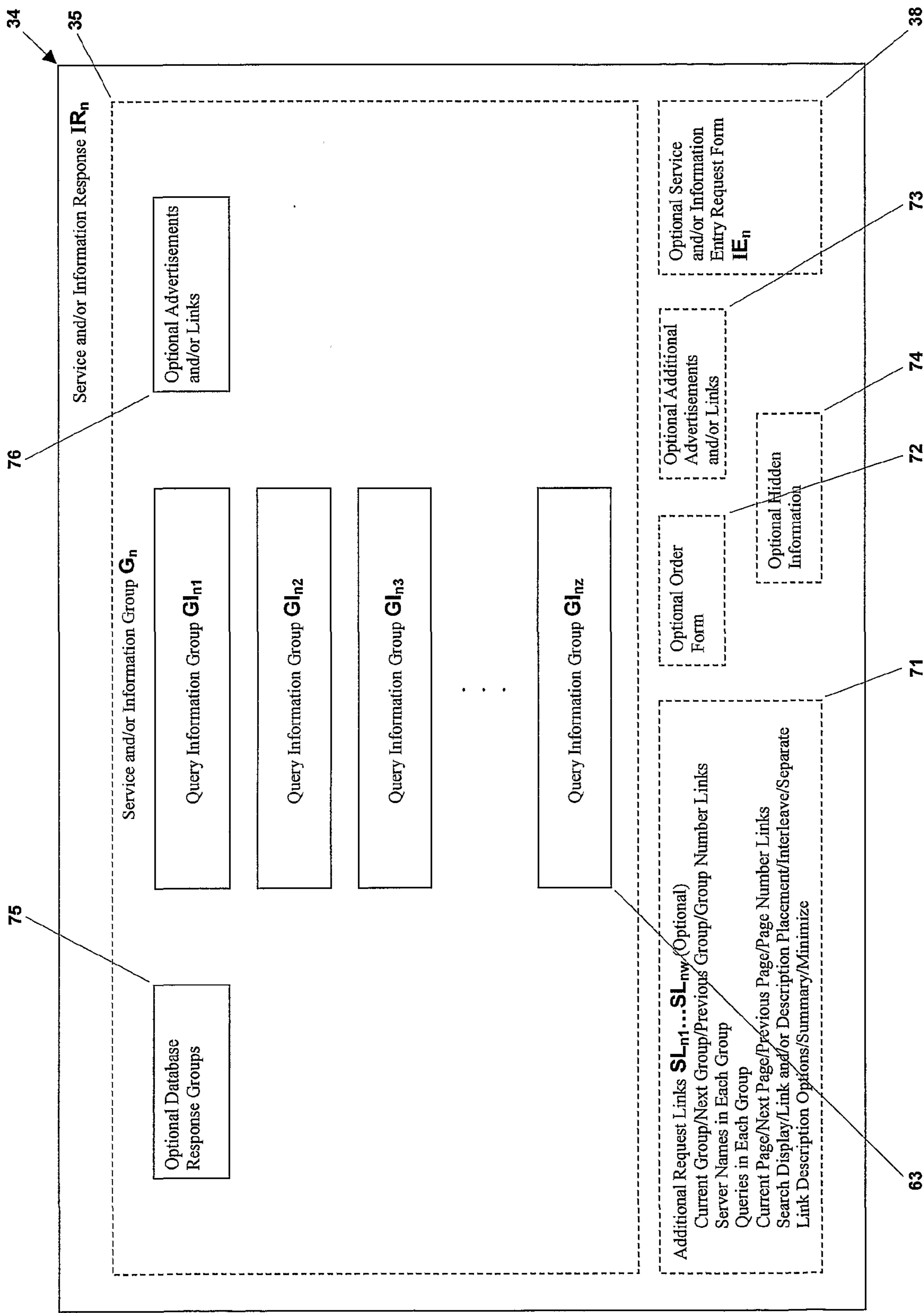

FIG. 13

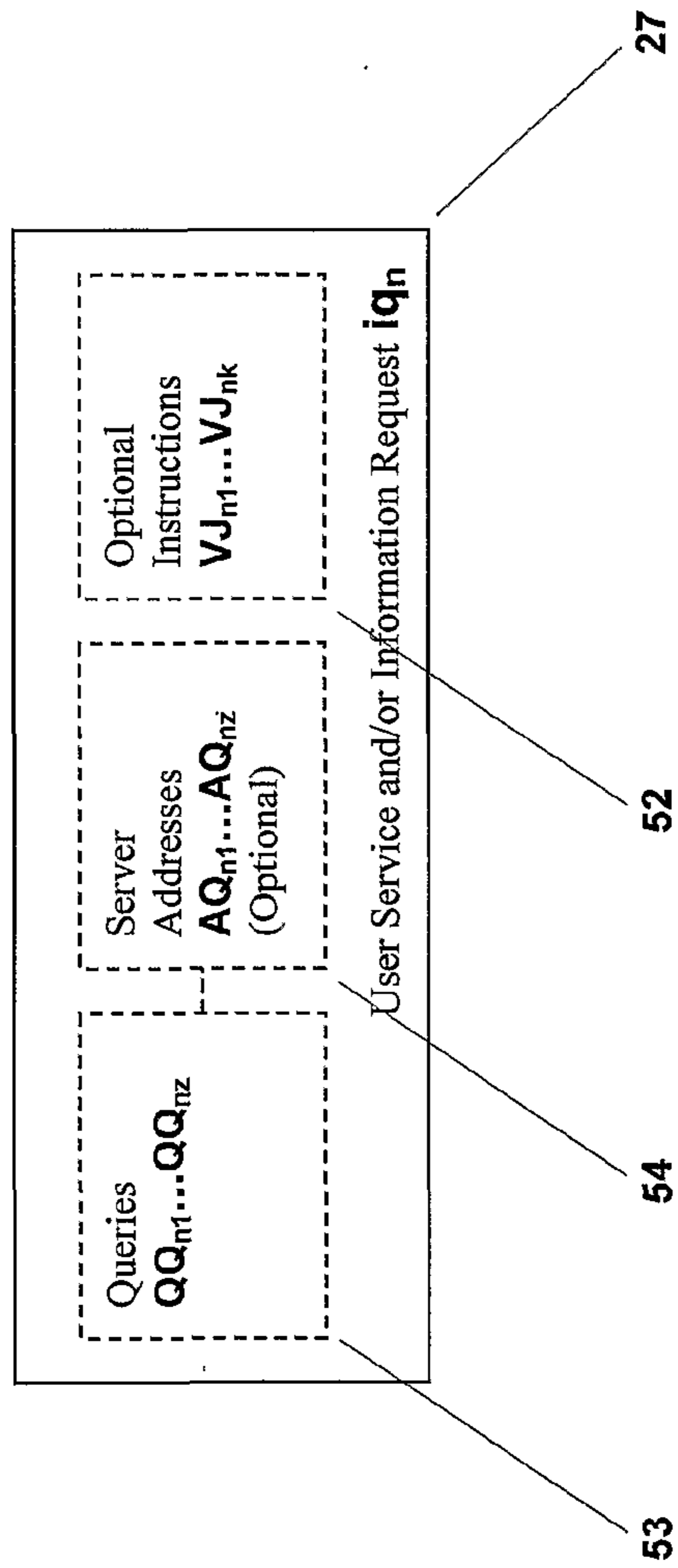

FIG. 14

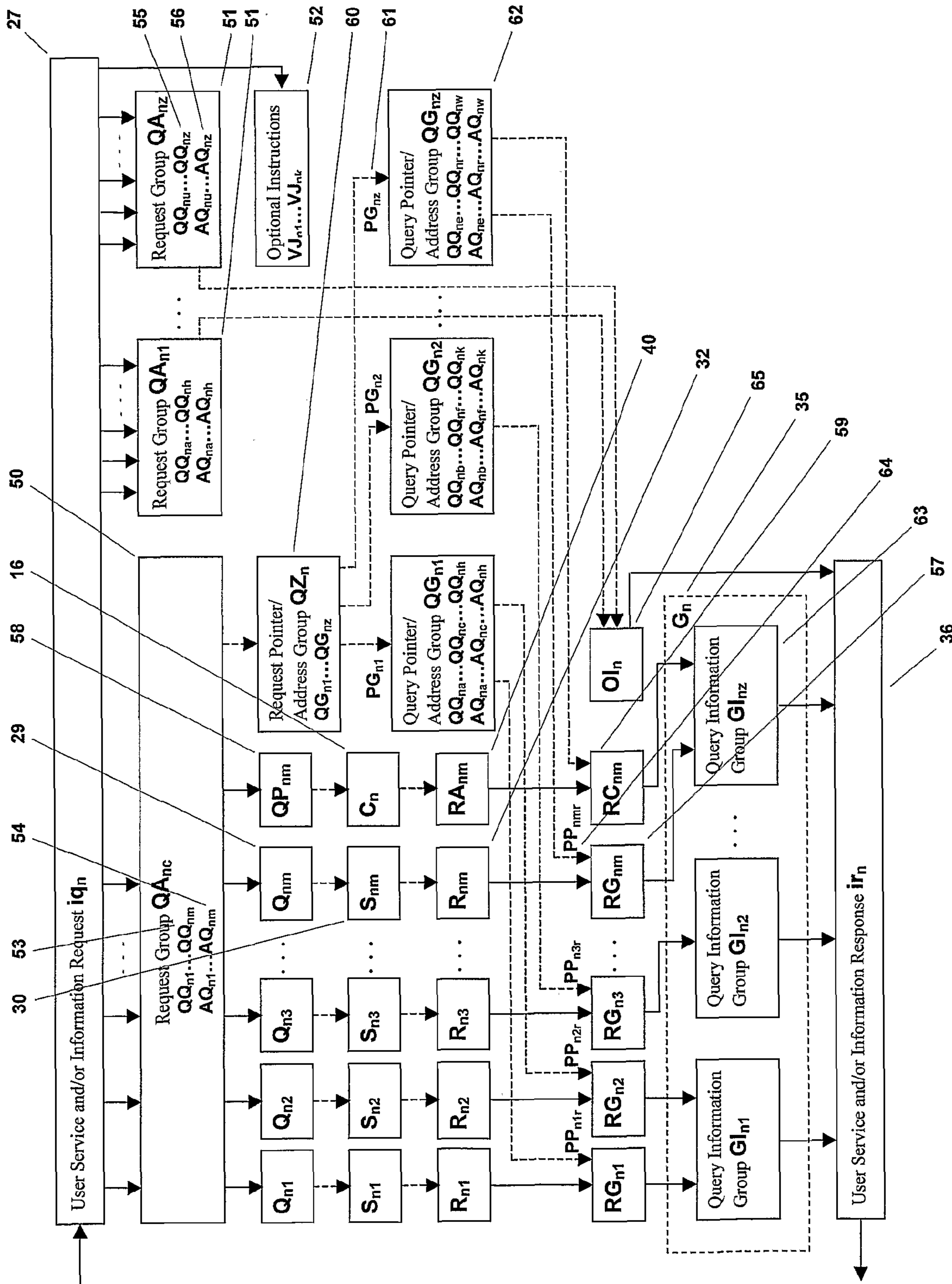

FIG. 15

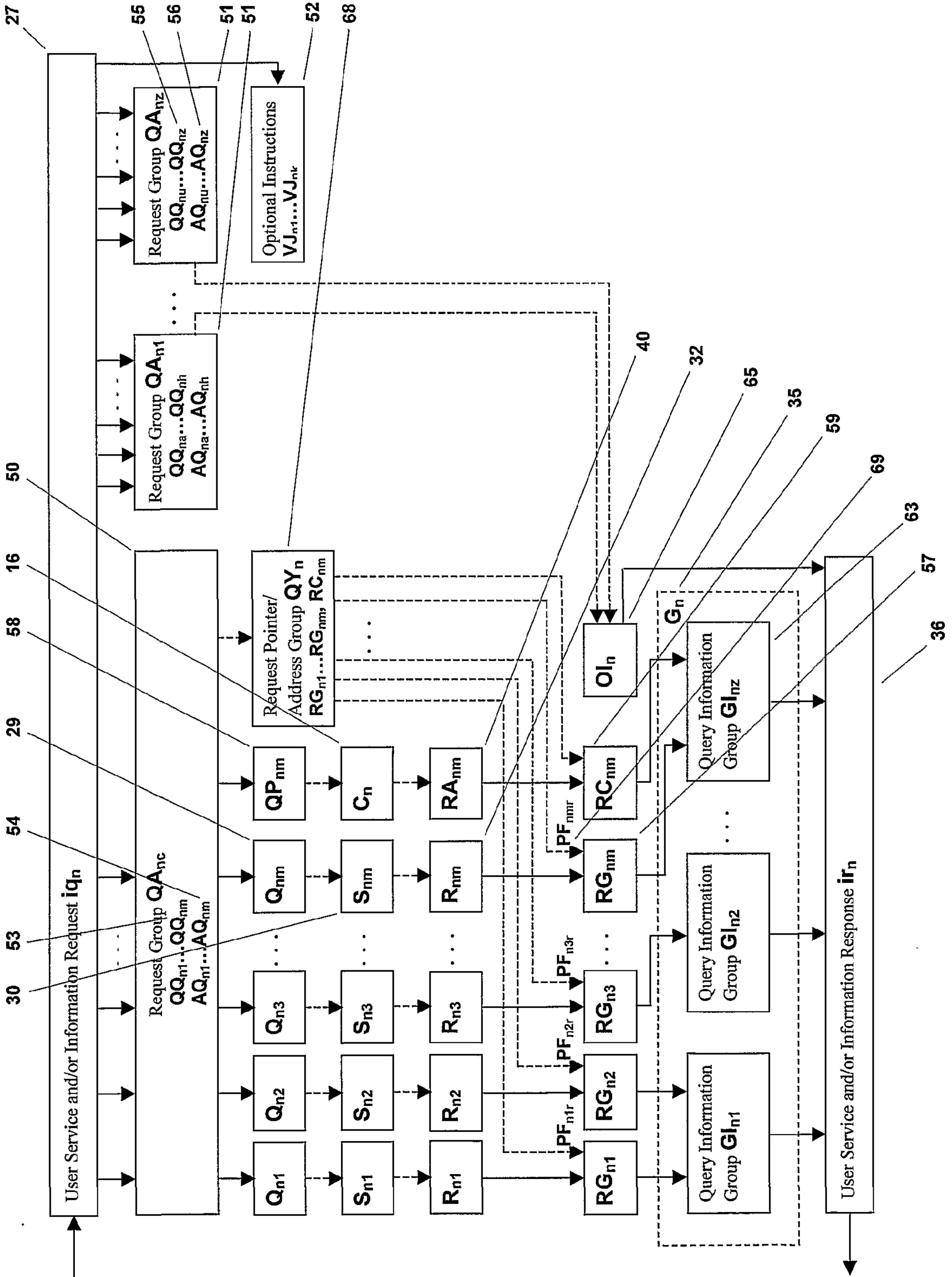

FIG. 16

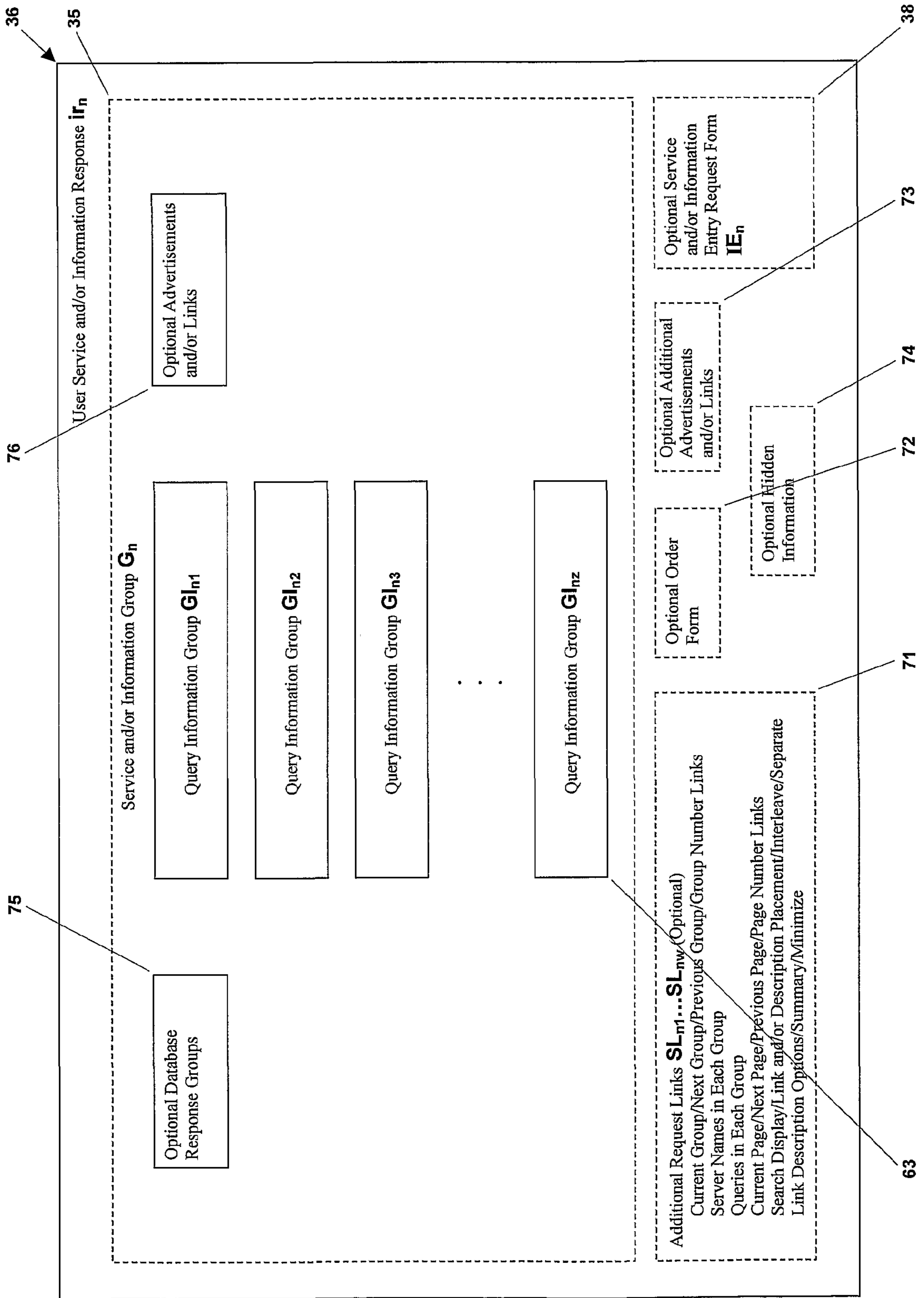

FIG. 17

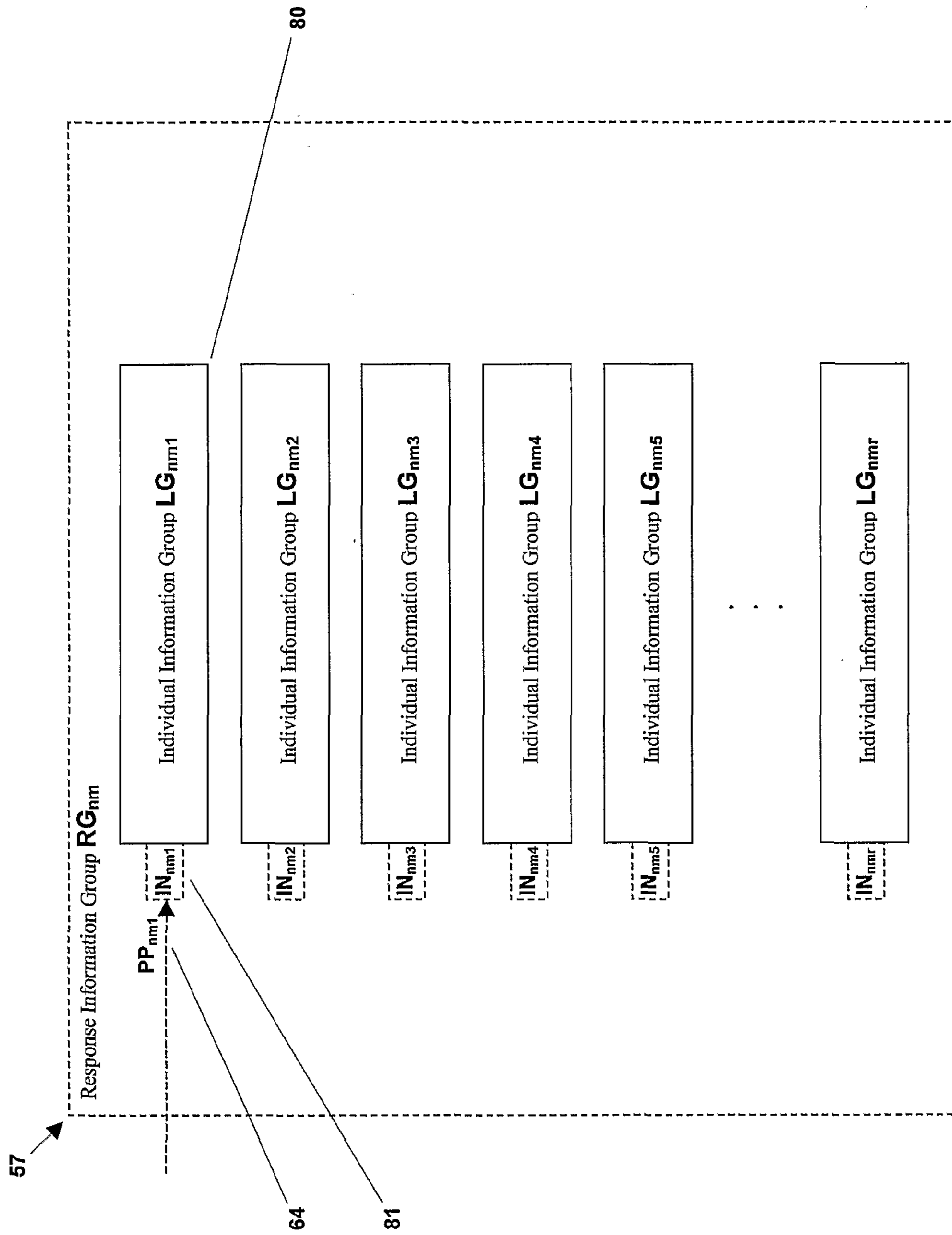

FIG. 18A

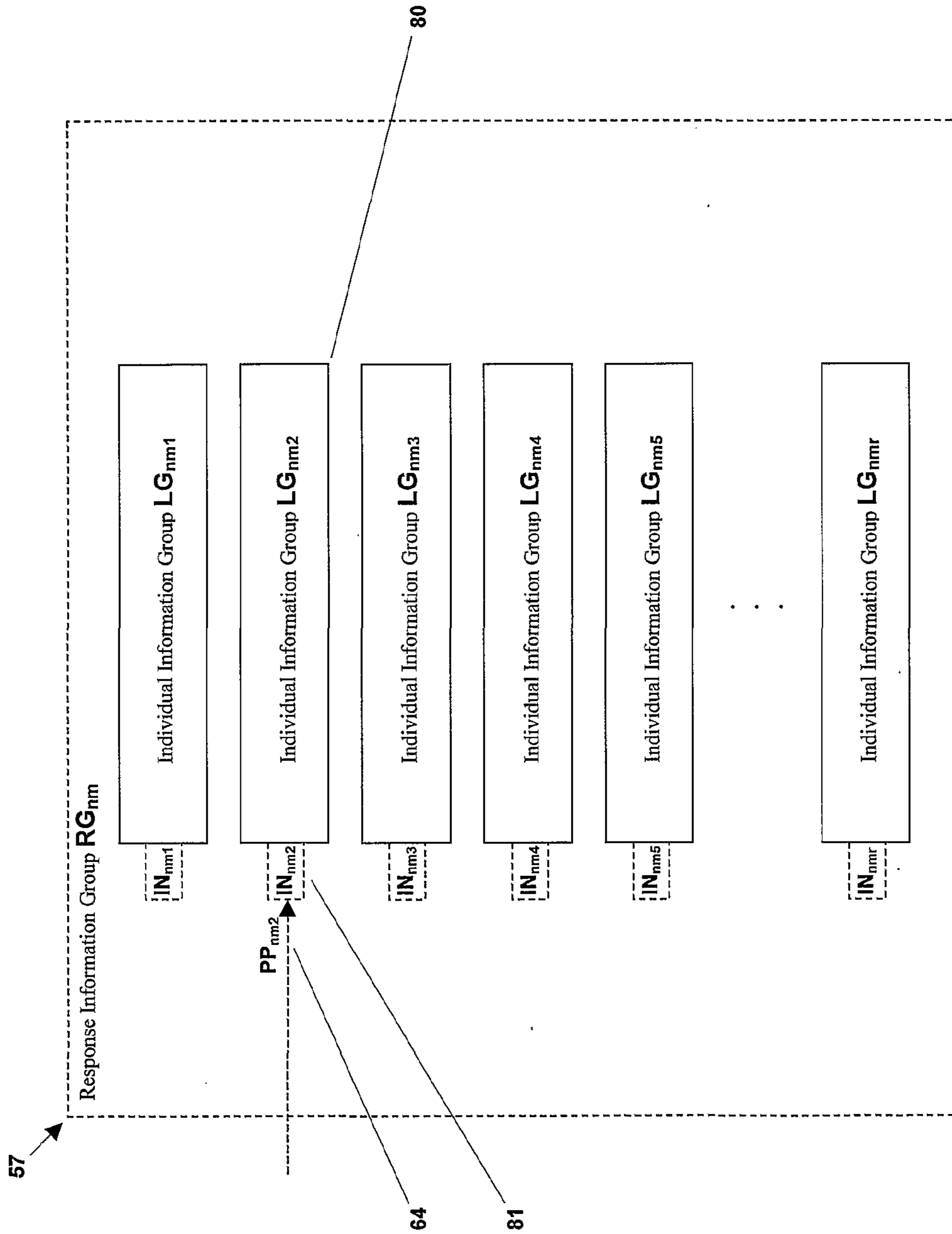

FIG. 18B

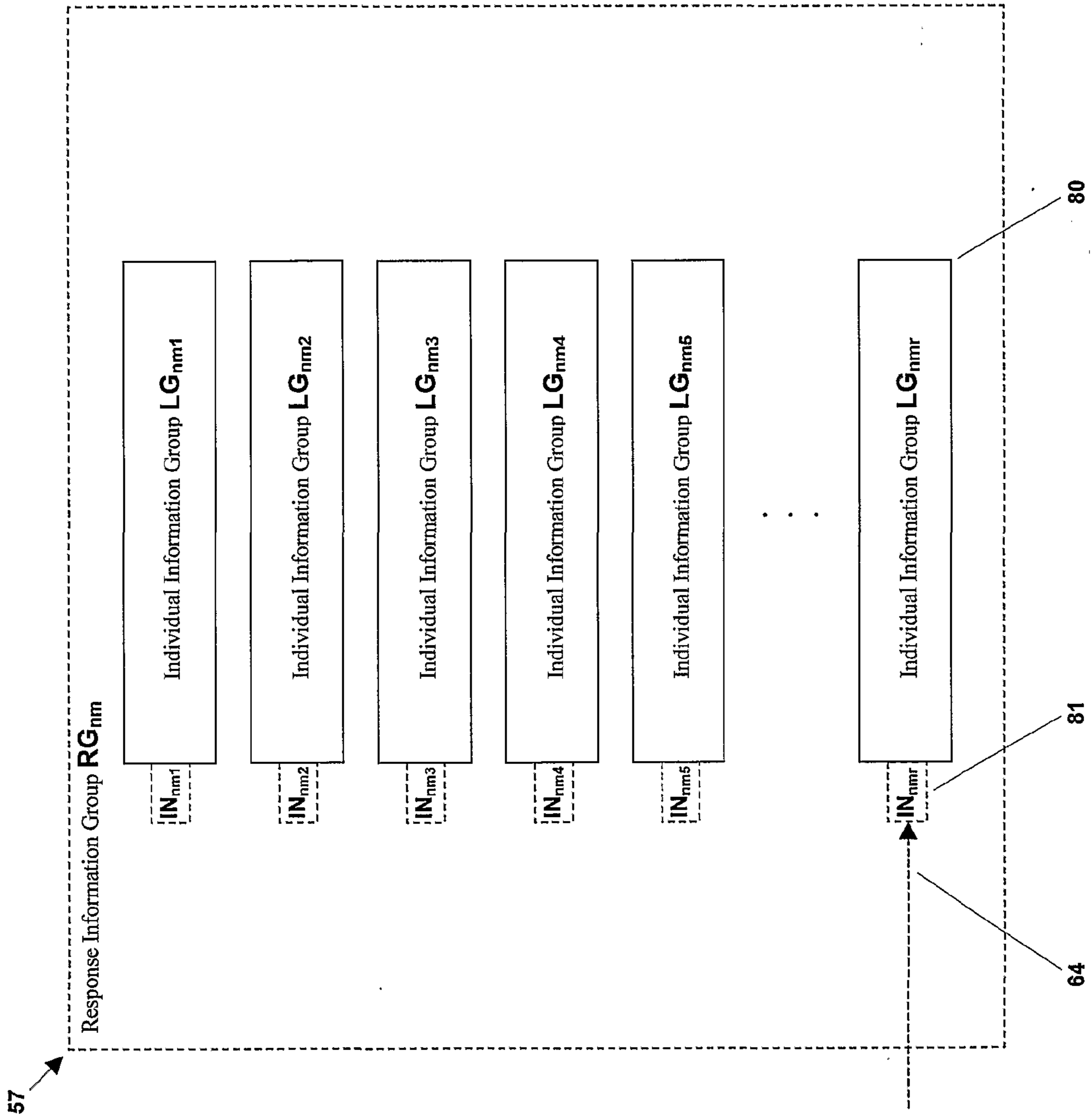

FIG. 18C

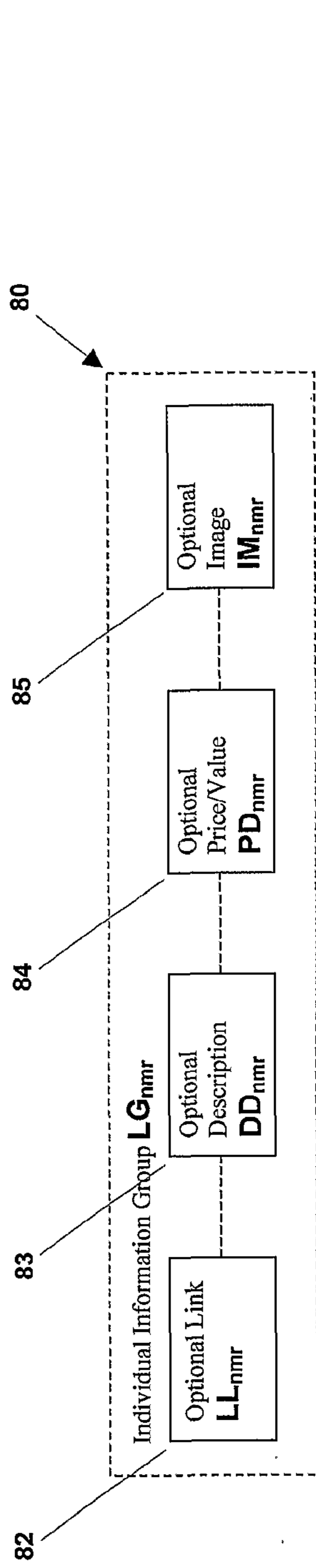

FIG. 19

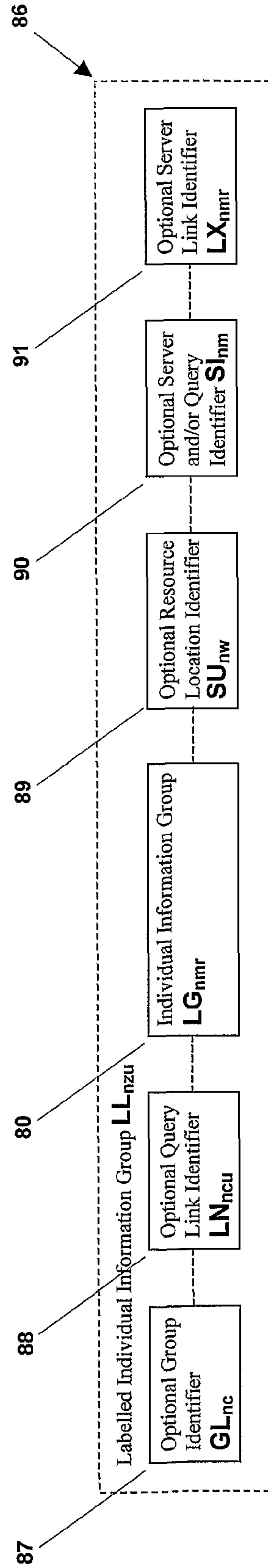

FIG. 20

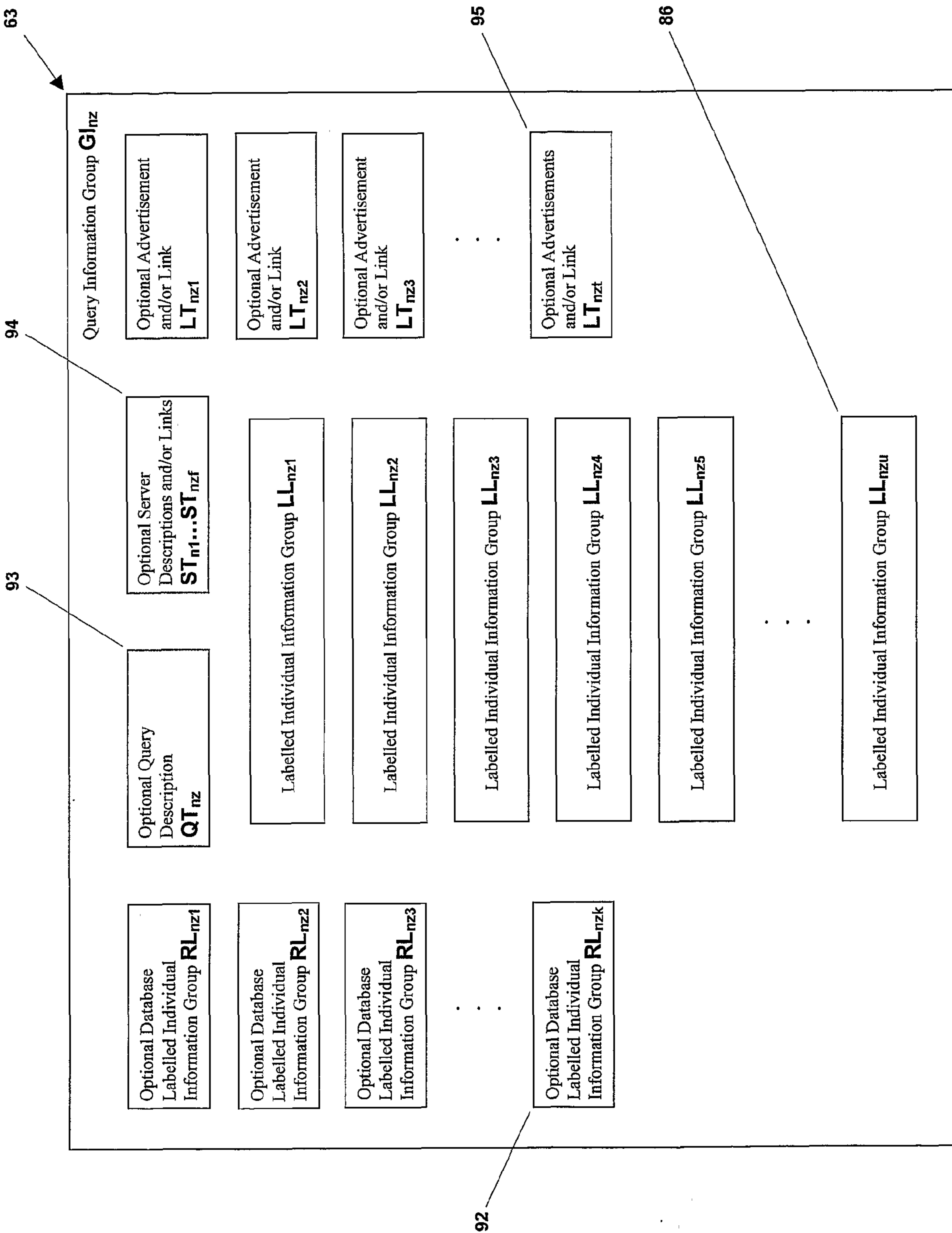
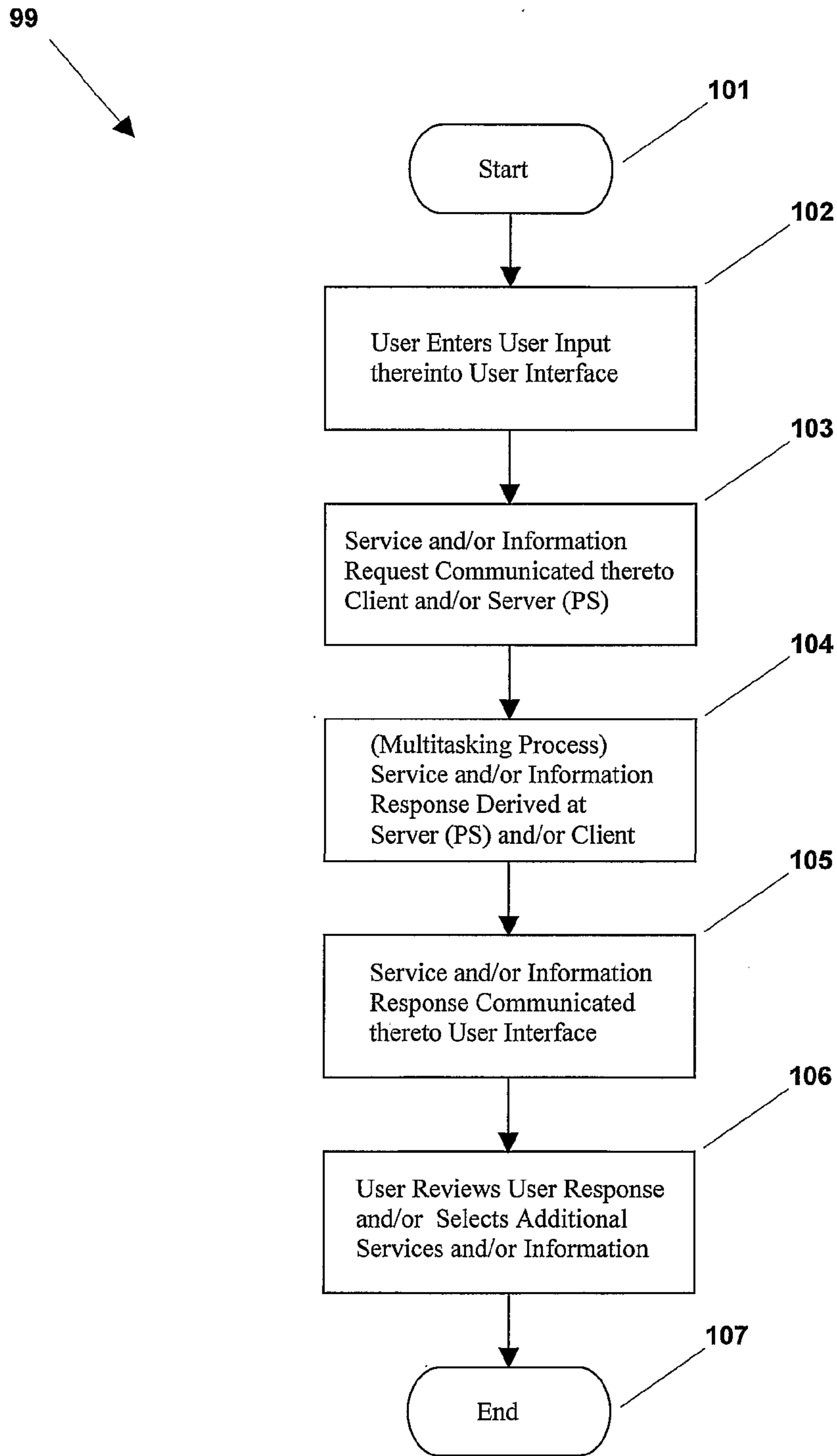

FIG. 21

**FIG. 22**

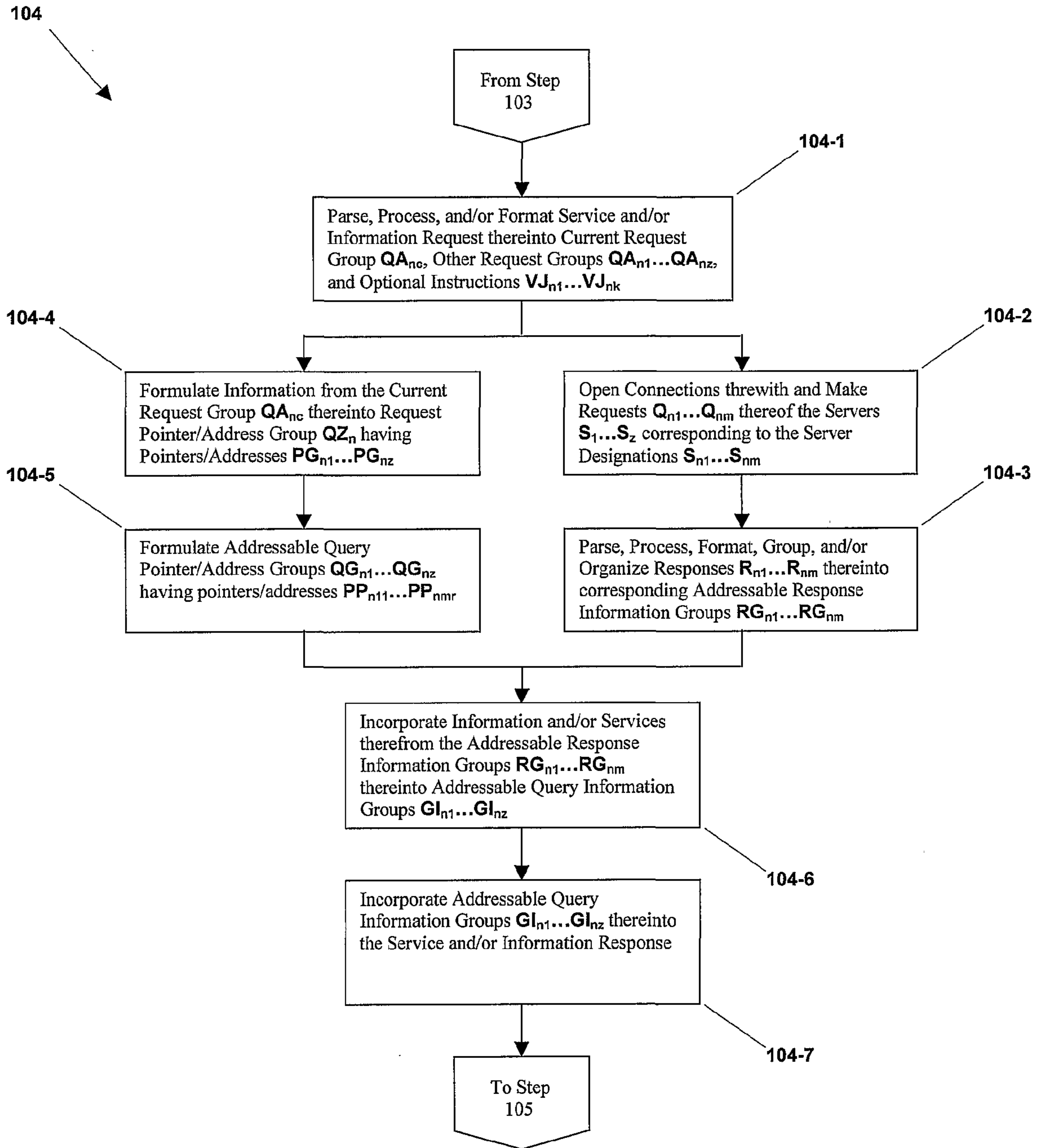

FIG. 22-1A

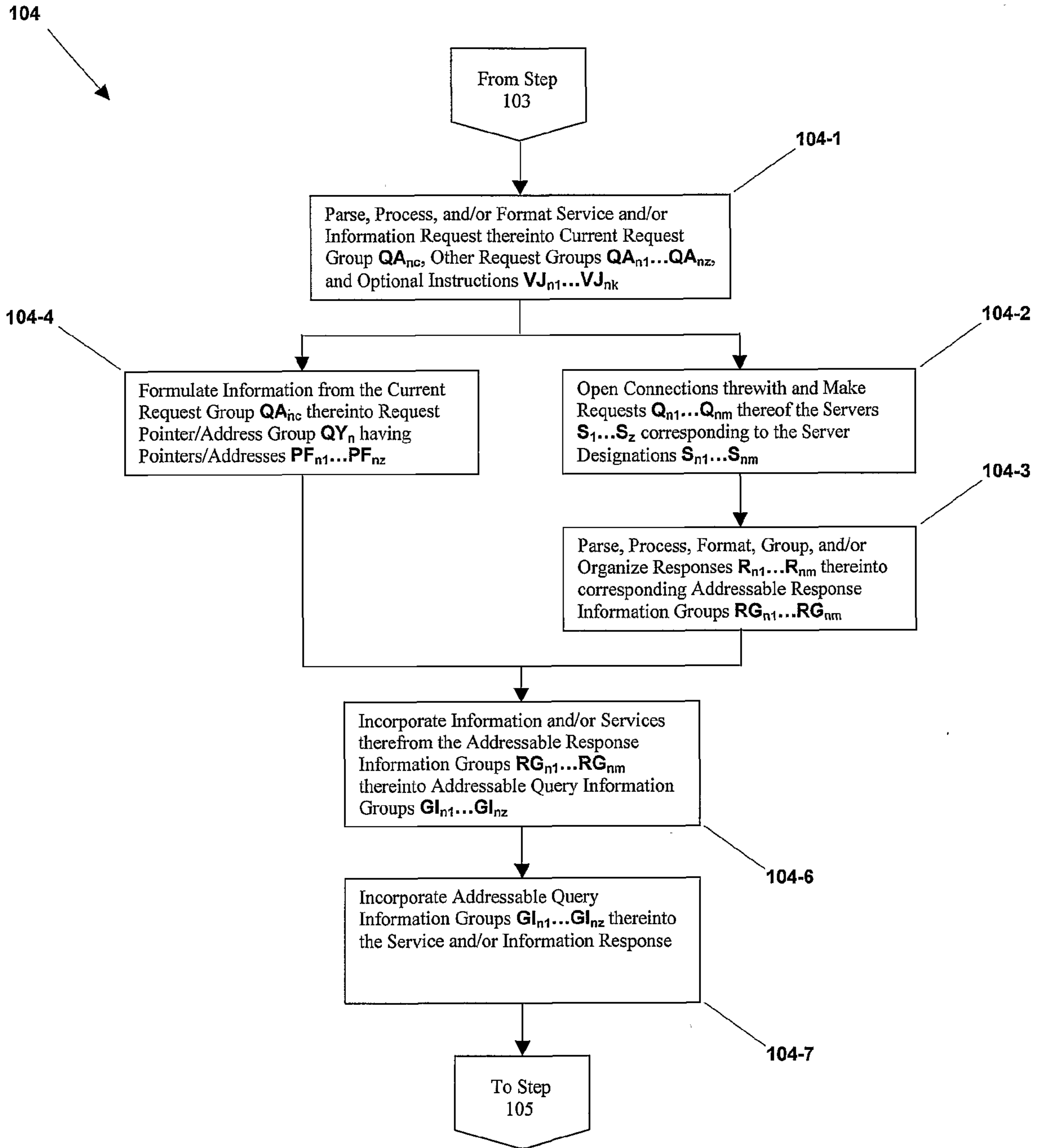

FIG. 22-1B

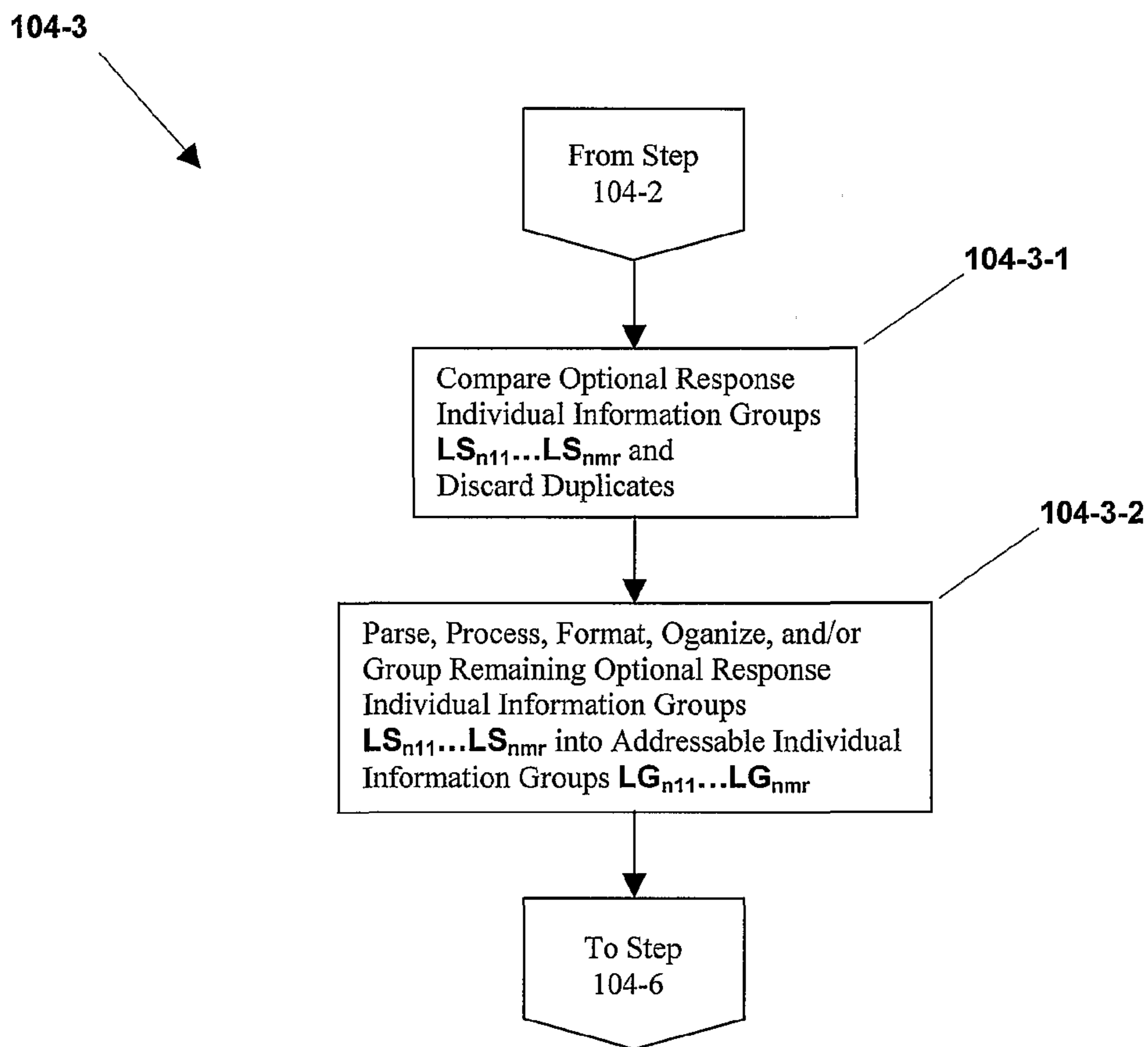

FIG. 22-1-1

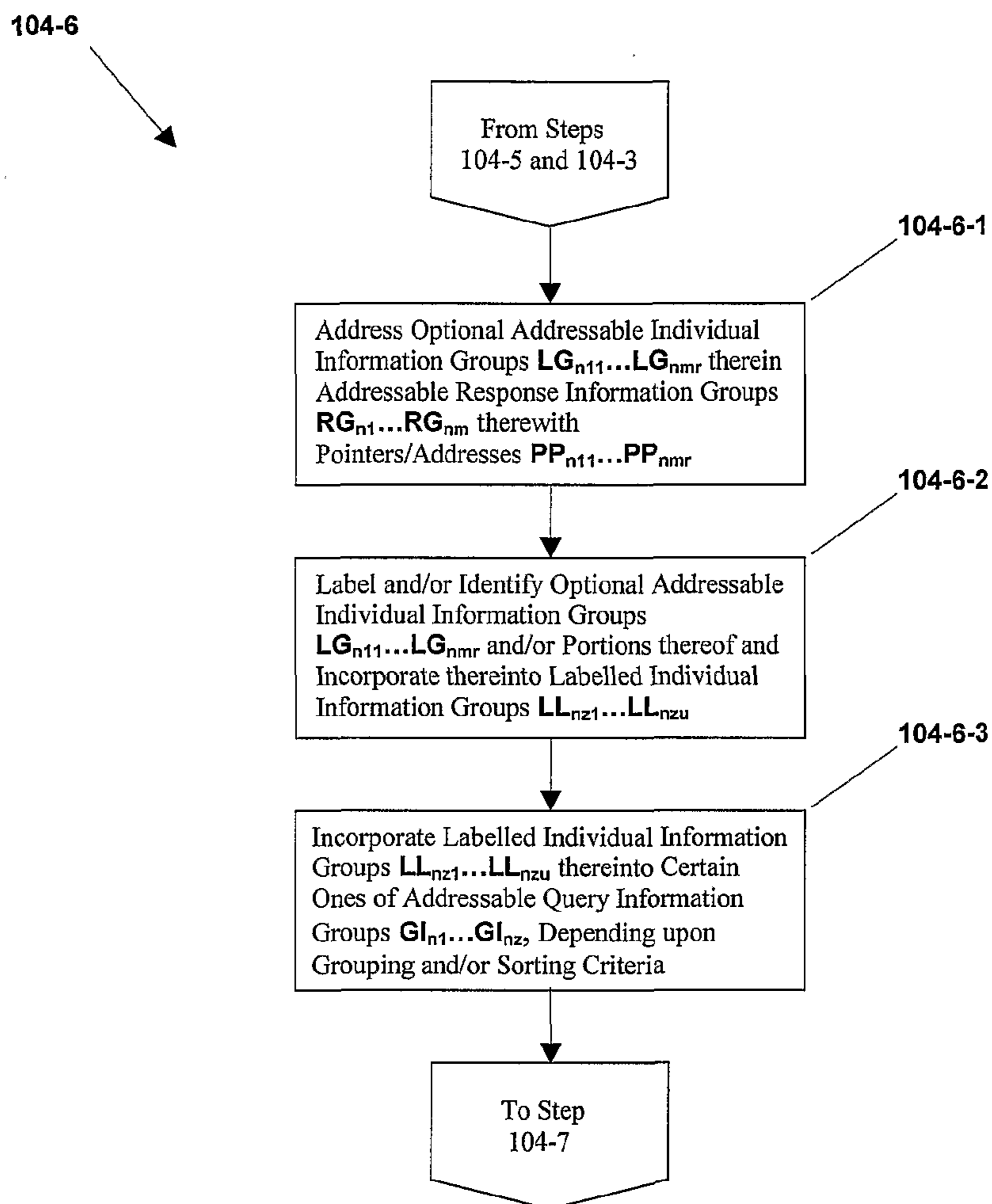

FIG. 22-1-2A

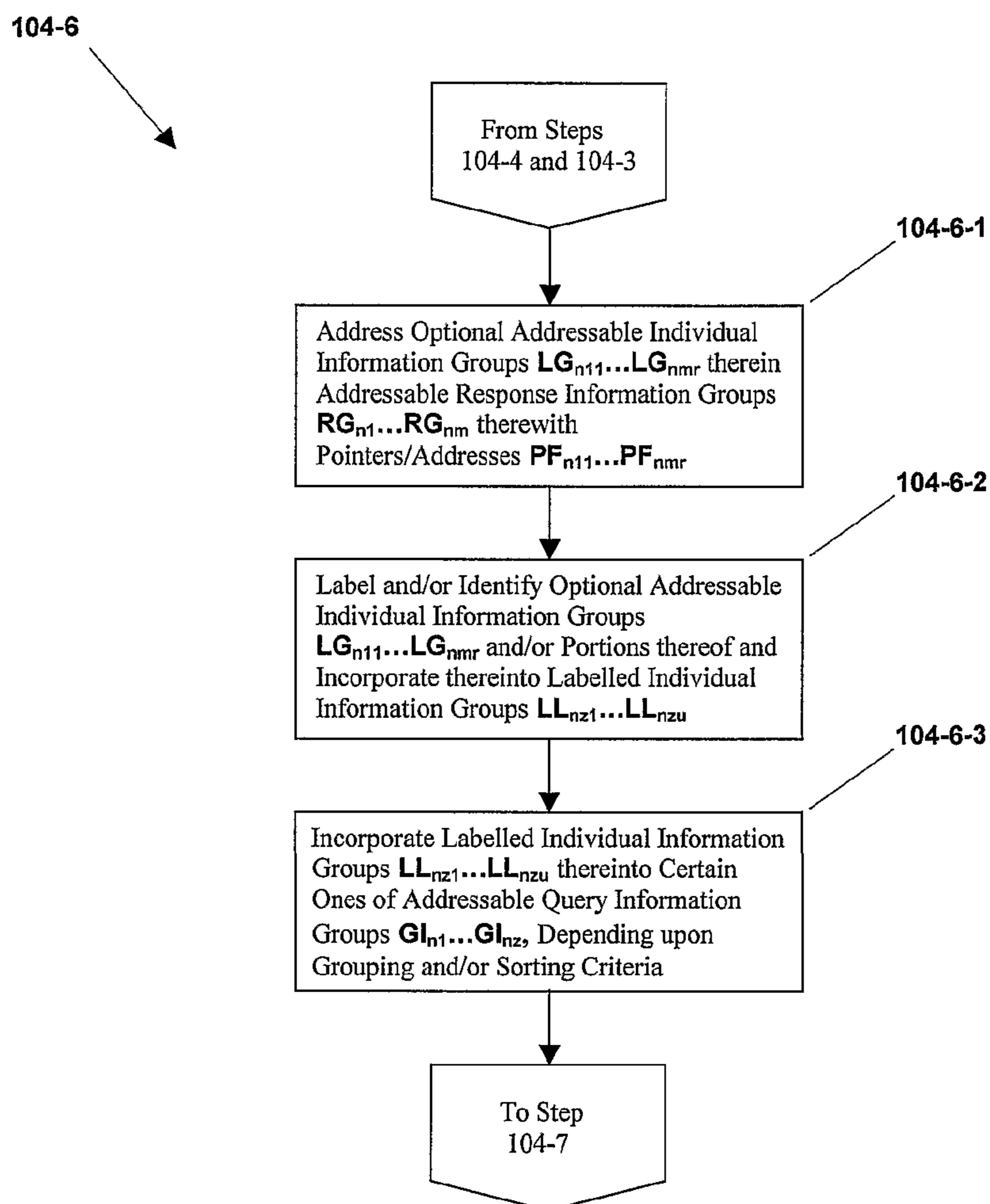

FIG. 22-1-2B

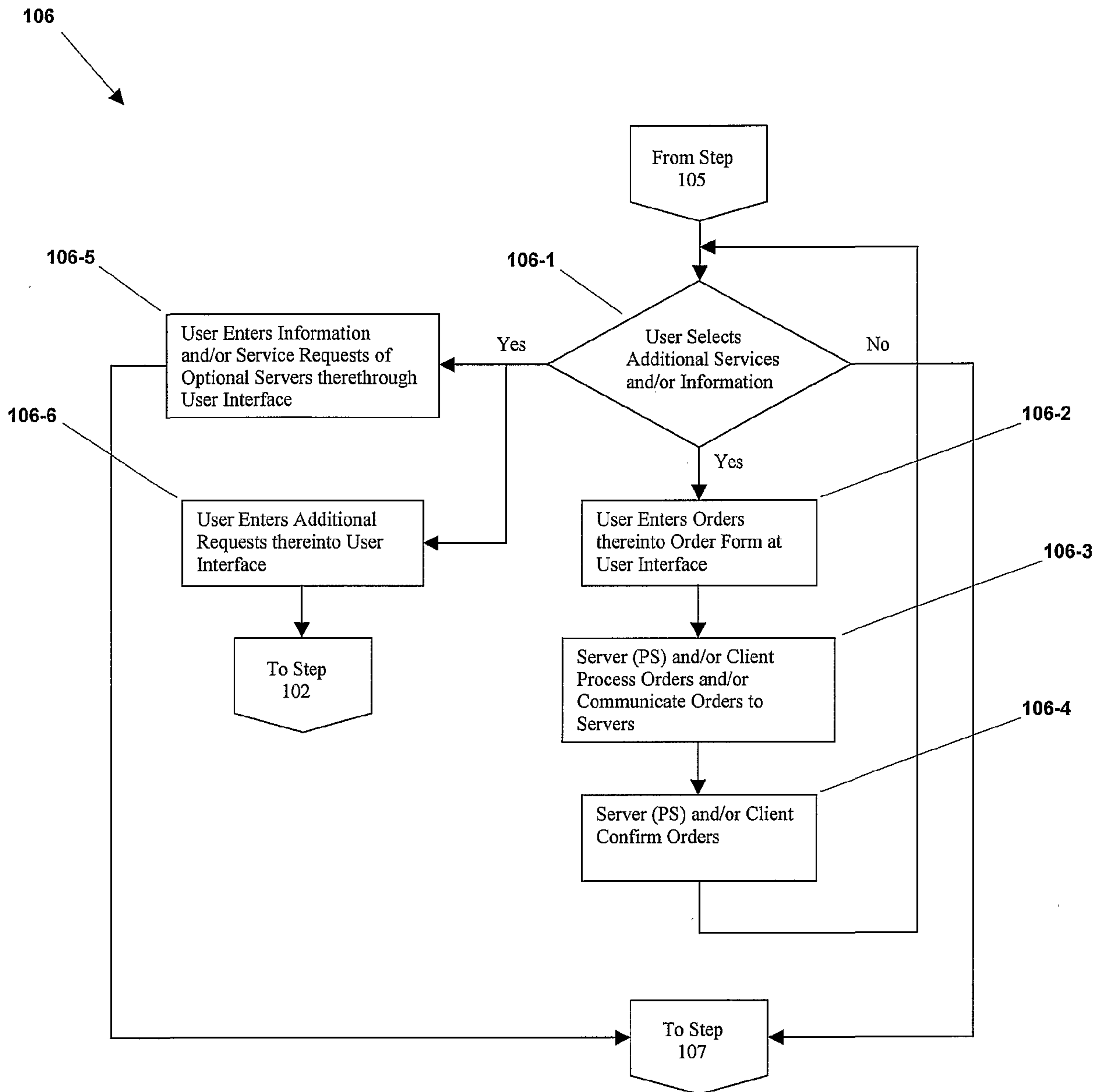

FIG. 22-2

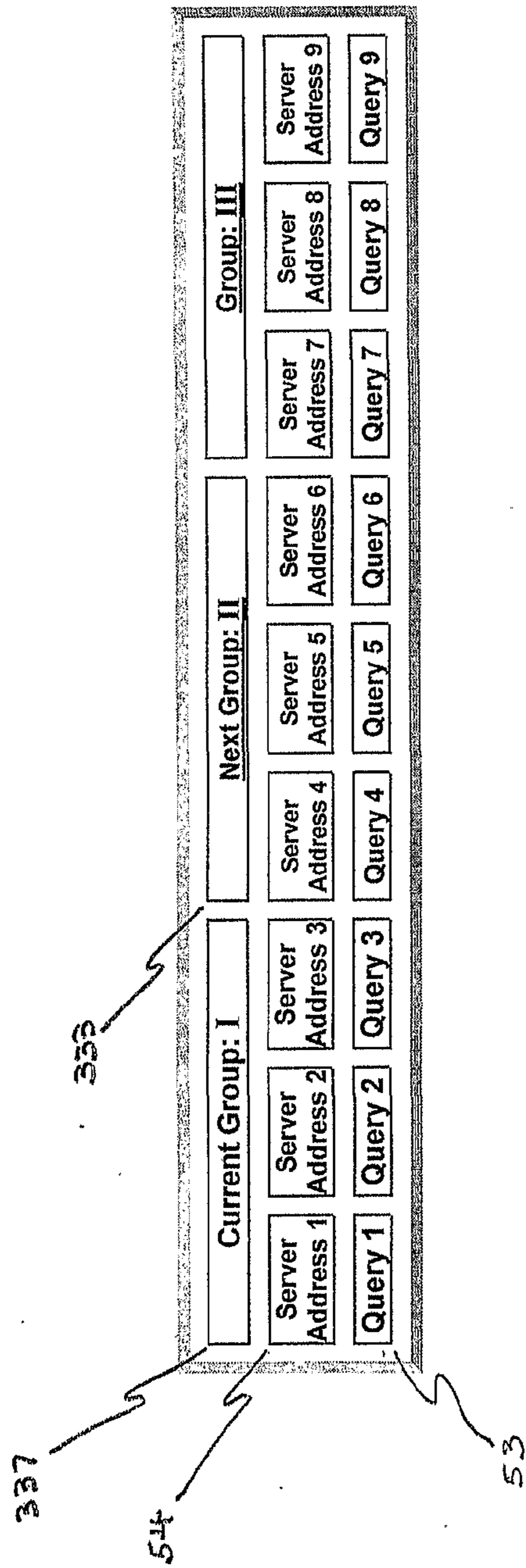

FIG. 23

Search'em All: Search your favorite search engines, all at the same time*

Search 1: Query 1

Search 2: Query 2

Search 3: Query 3

Search 4: Query 4

Search 5: Query 5

Search 6: Query 6

Search 7: Query 7

Search 8: Query 8

Search 9: Query 9

Search Engine Results: * Only 1 entry required

URL Details: * Only 1 entry required

Previous Group: I

Current Group: II

Next Group: III

Go to page: 1 2 3 4 5 6 7 8 9 10 Go to: [Previous Page] [Next Page]

11 12 13 14 15 16 17 18 19 20
21 22 23 24 25

Search Display (Interleaved or separately by search engine): [Separate]
Description or List (Site descriptions or lists): [List]

FIG. 24

Interleave	331A-1
Separate	331A-2
Combine \$[a-z]	331A-3
Combine \$[z-a]	331A-4
Separate \$[a-z]	331A-5
Separate \$[z-a]	331A-6

FIG. 25

Summary	332A-1
List	332A-2

FIG. 26

Current Group: I

Server Address 1	Server Address 2	Server Address 3	Server Address 4	Server Address 5	Server Address 6	Server Address 7	Server Address 8	Server Address 9
Query 1	Query 2	Query 3	Query 4	Query 6	Query 6	Query 7	Query 8	Query 9

Go to page: 1 2 3 4 5 6 7 8 9

Search Display *(interleaved or separately by search engine):*

Interleaved Combine \$[a-z] Combine \$[z-a]
Separate Separate \$[a-z] Separate \$[z-a]
 Description or List *(Site descriptions or lists):* [List]

331B-1 331B-2 331B-5 331B-3 331B-6 331B-4

FIG. 27

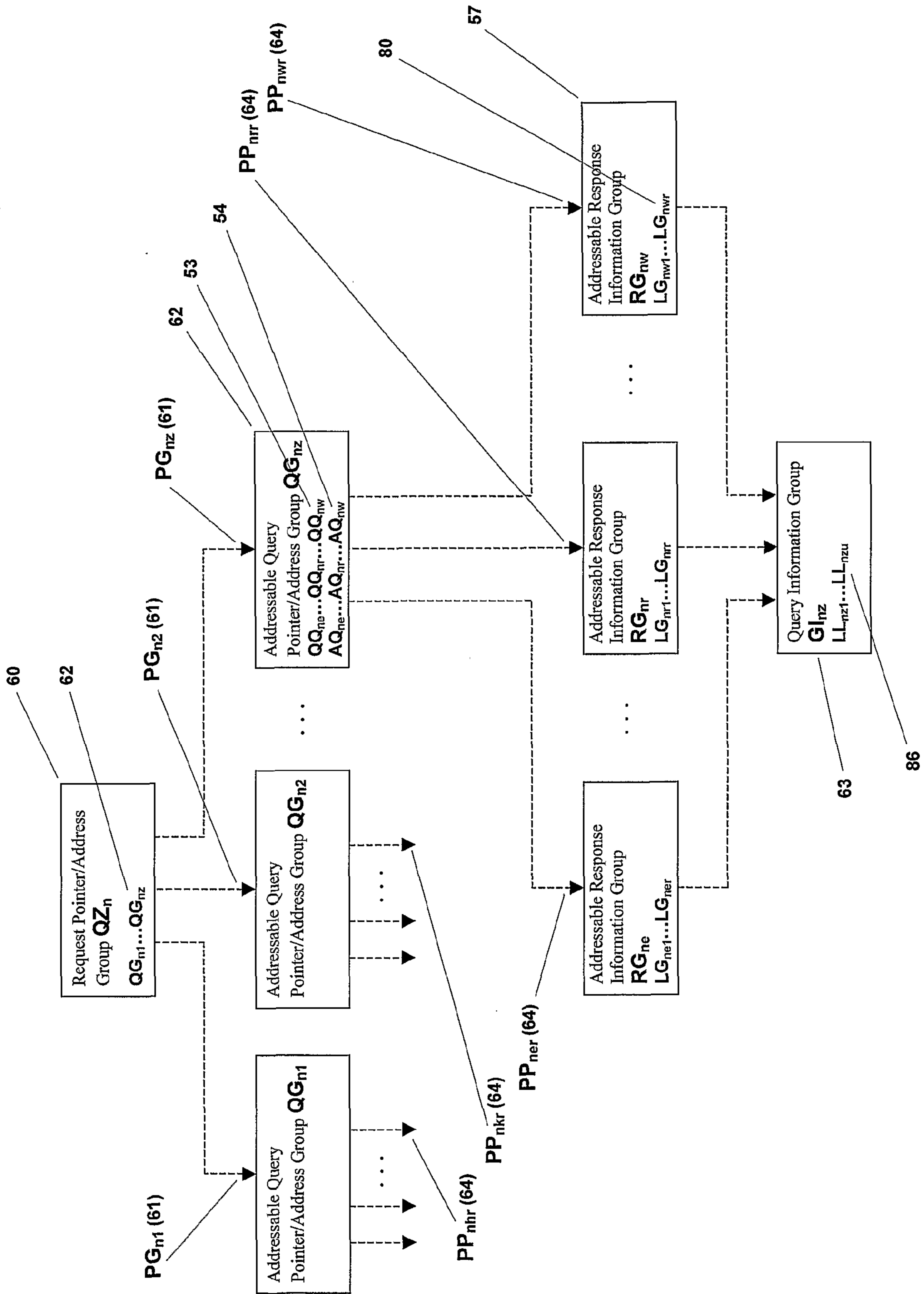

FIG. 28

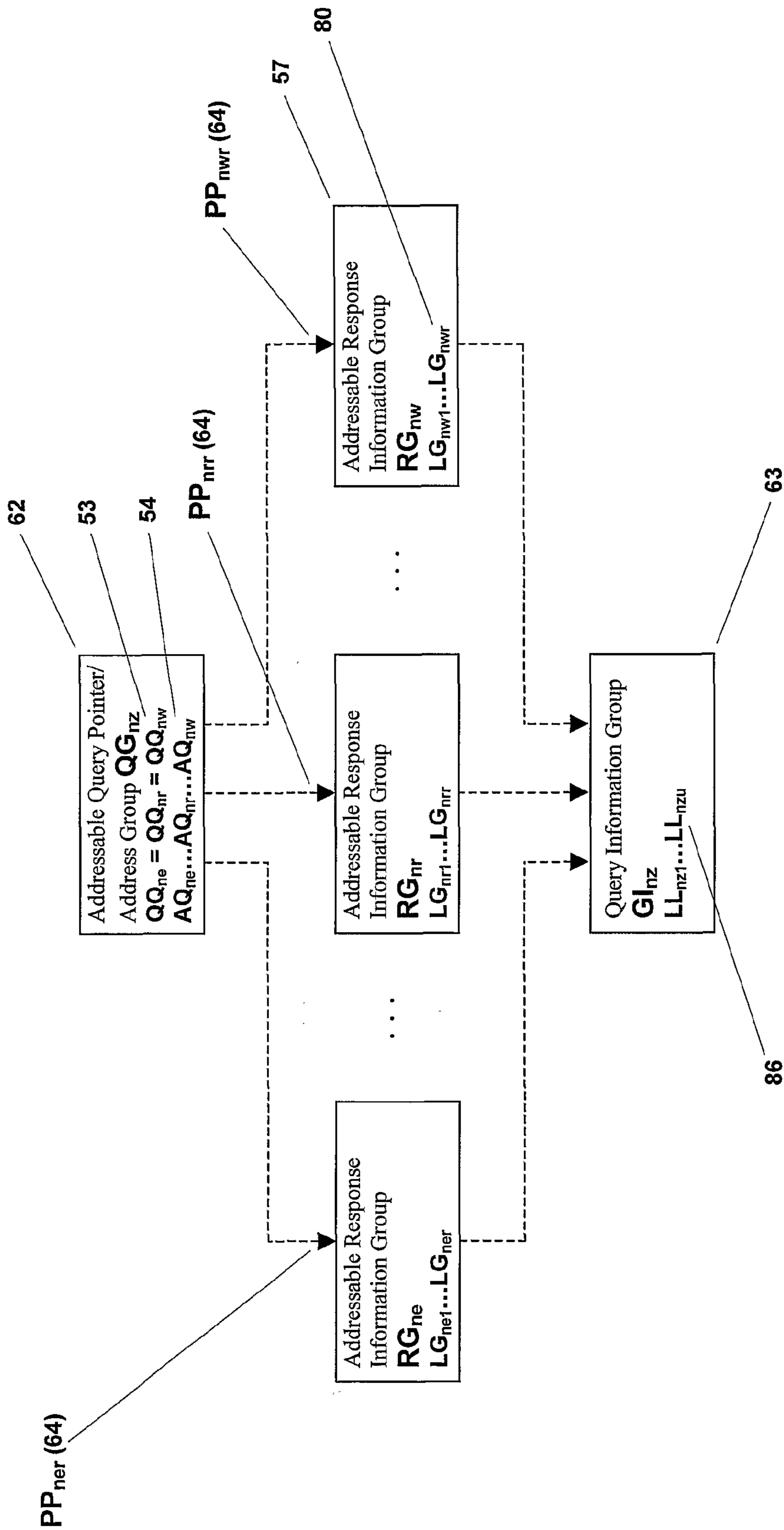

FIG. 29

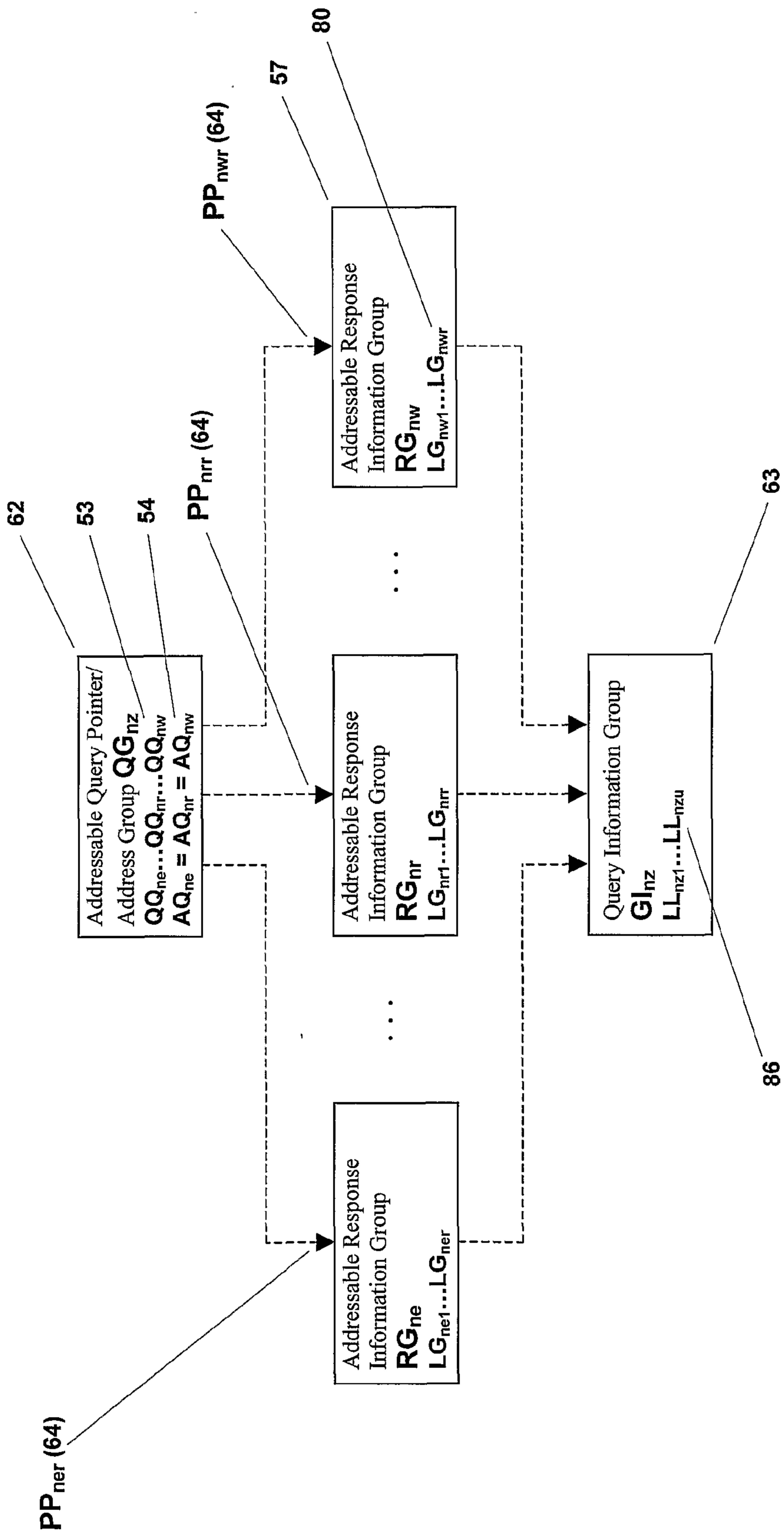

FIG. 30

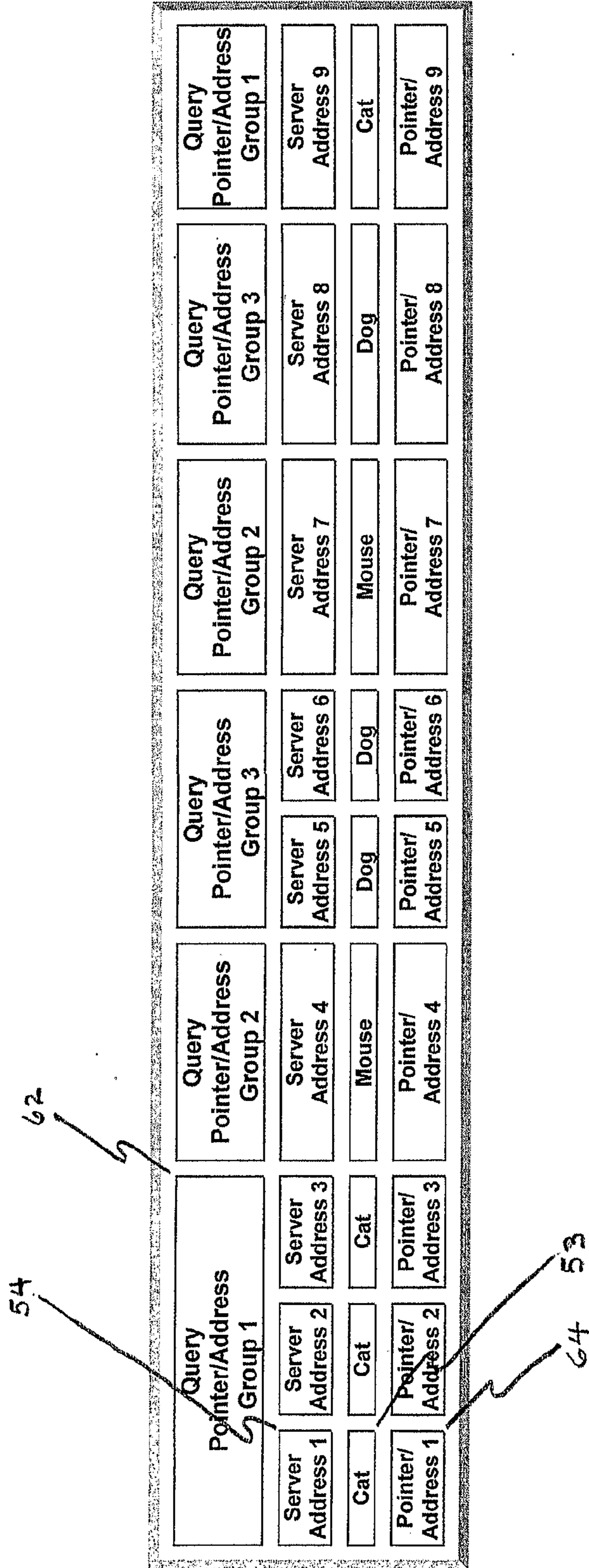

FIG. 31

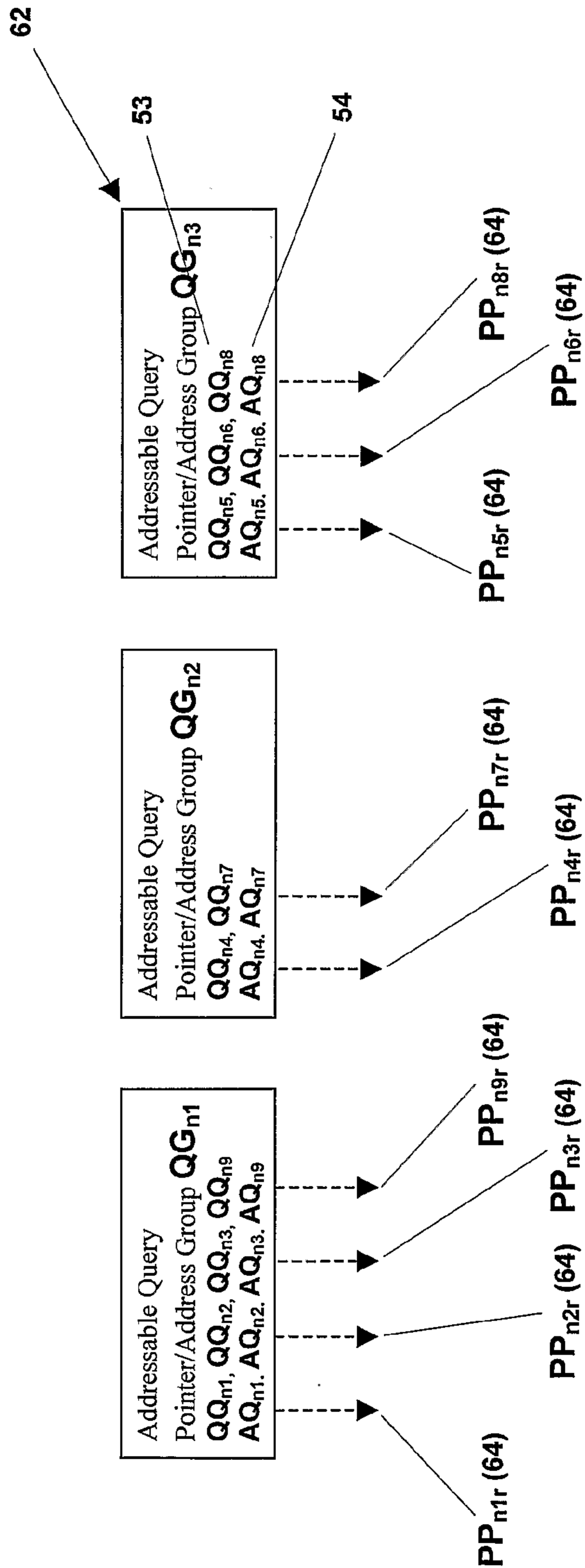

FIG. 32

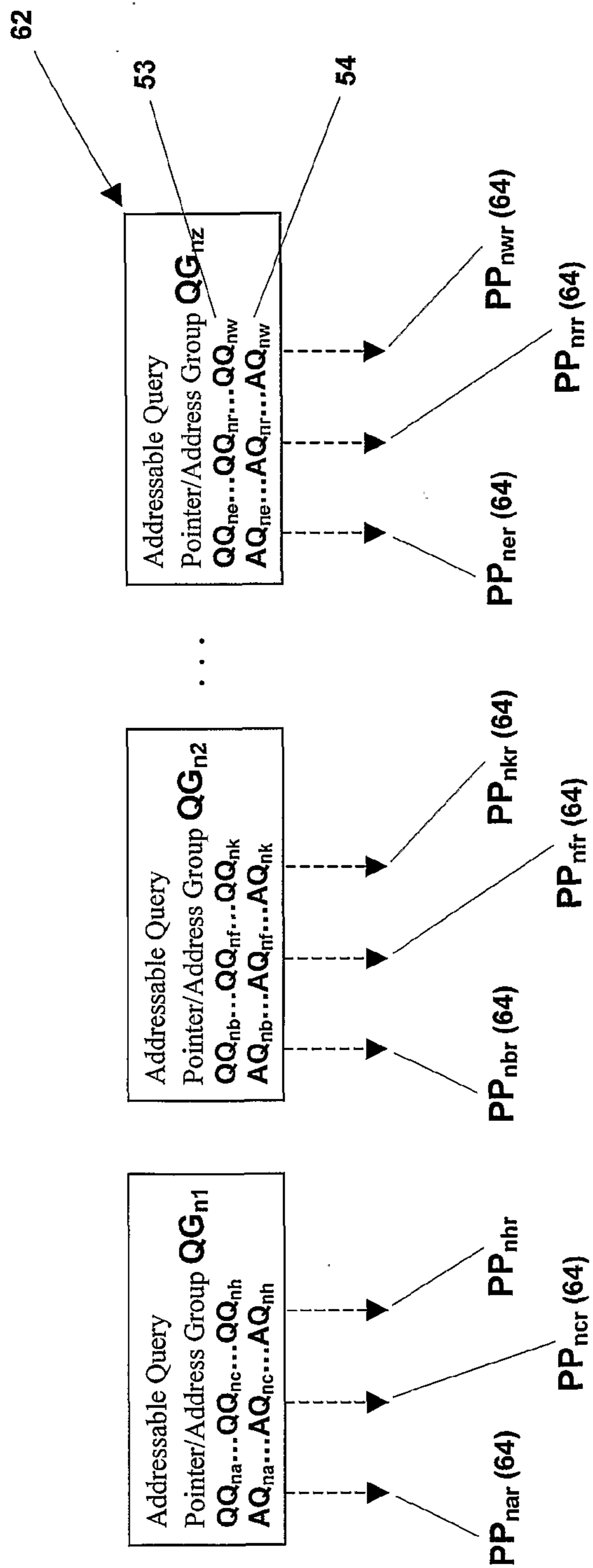

FIG. 33

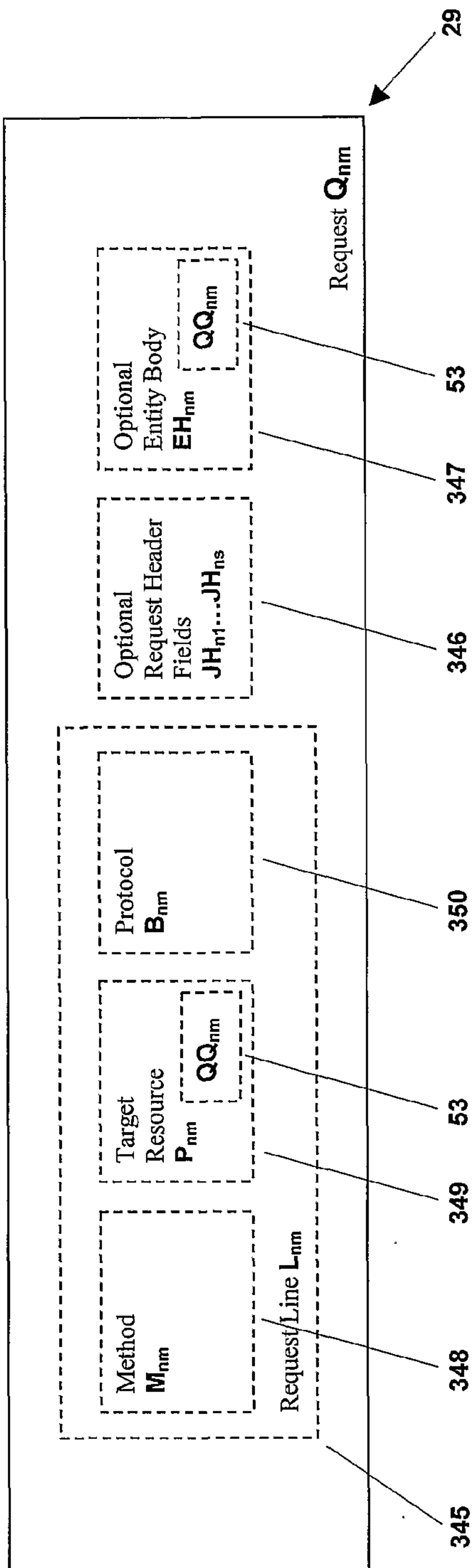

FIG. 34

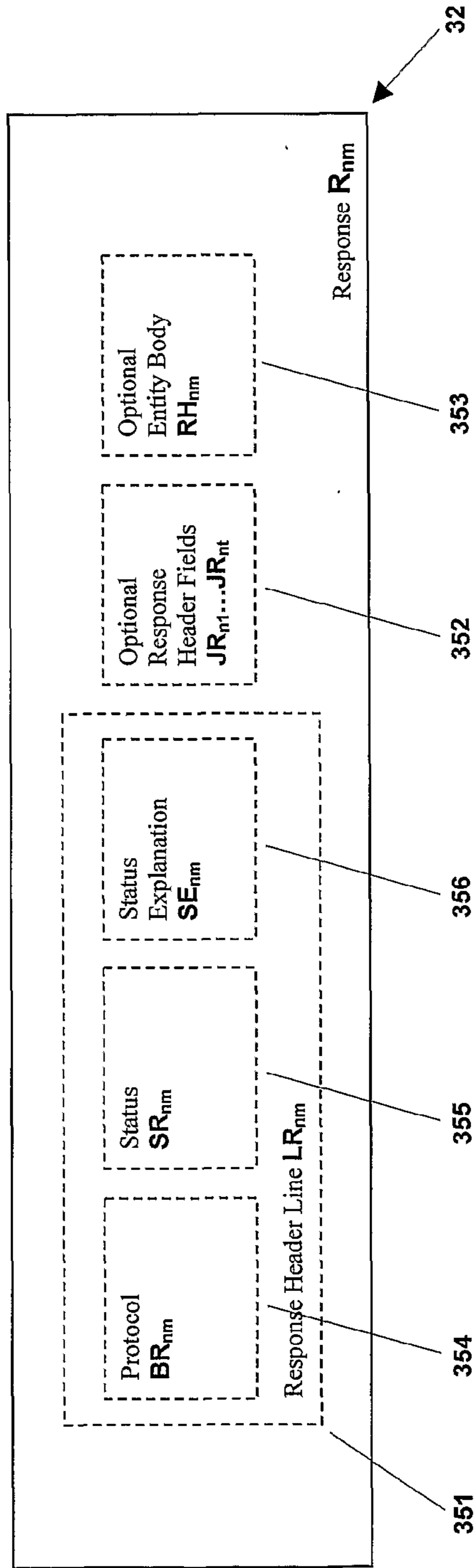

FIG. 35

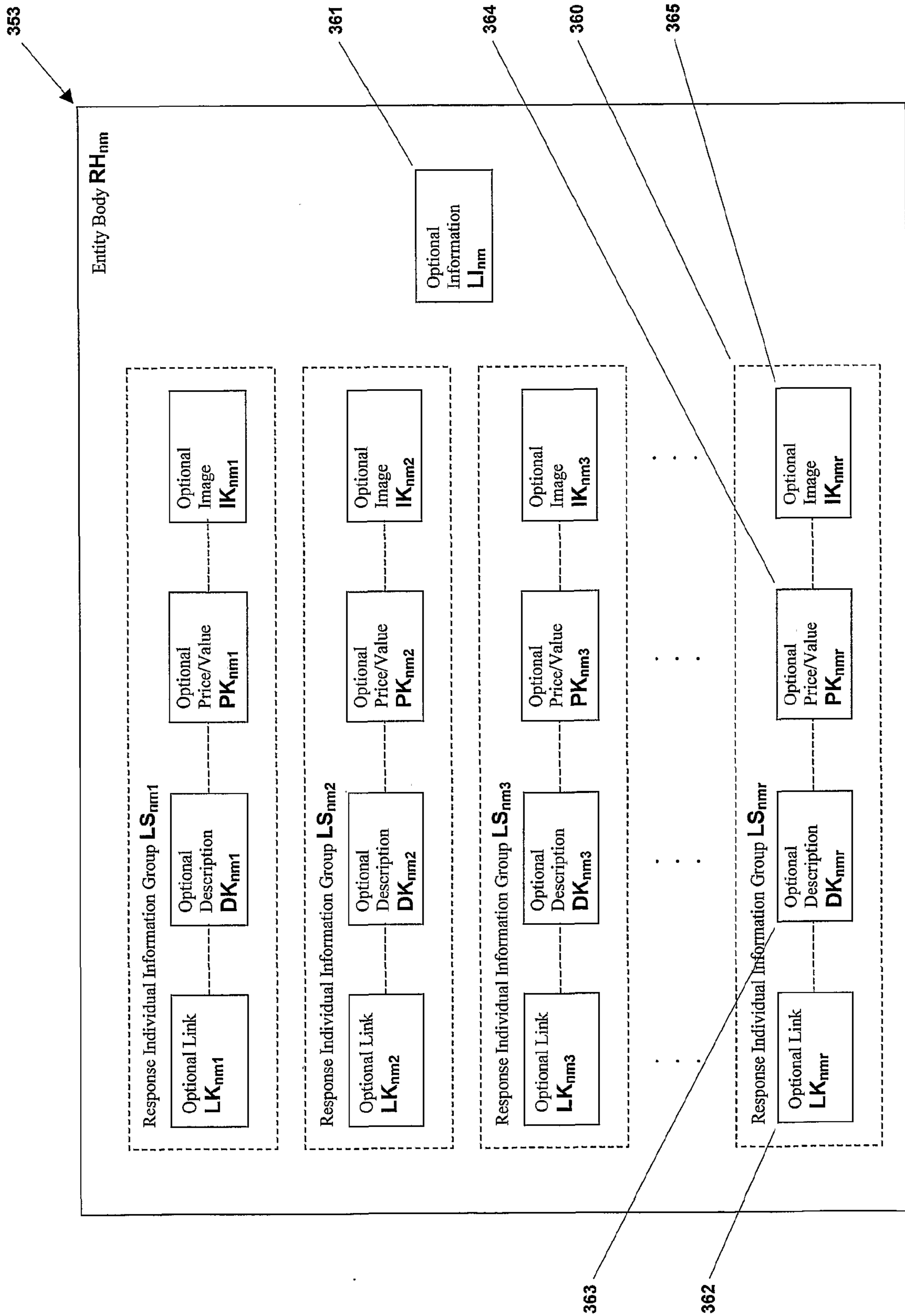

FIG. 36

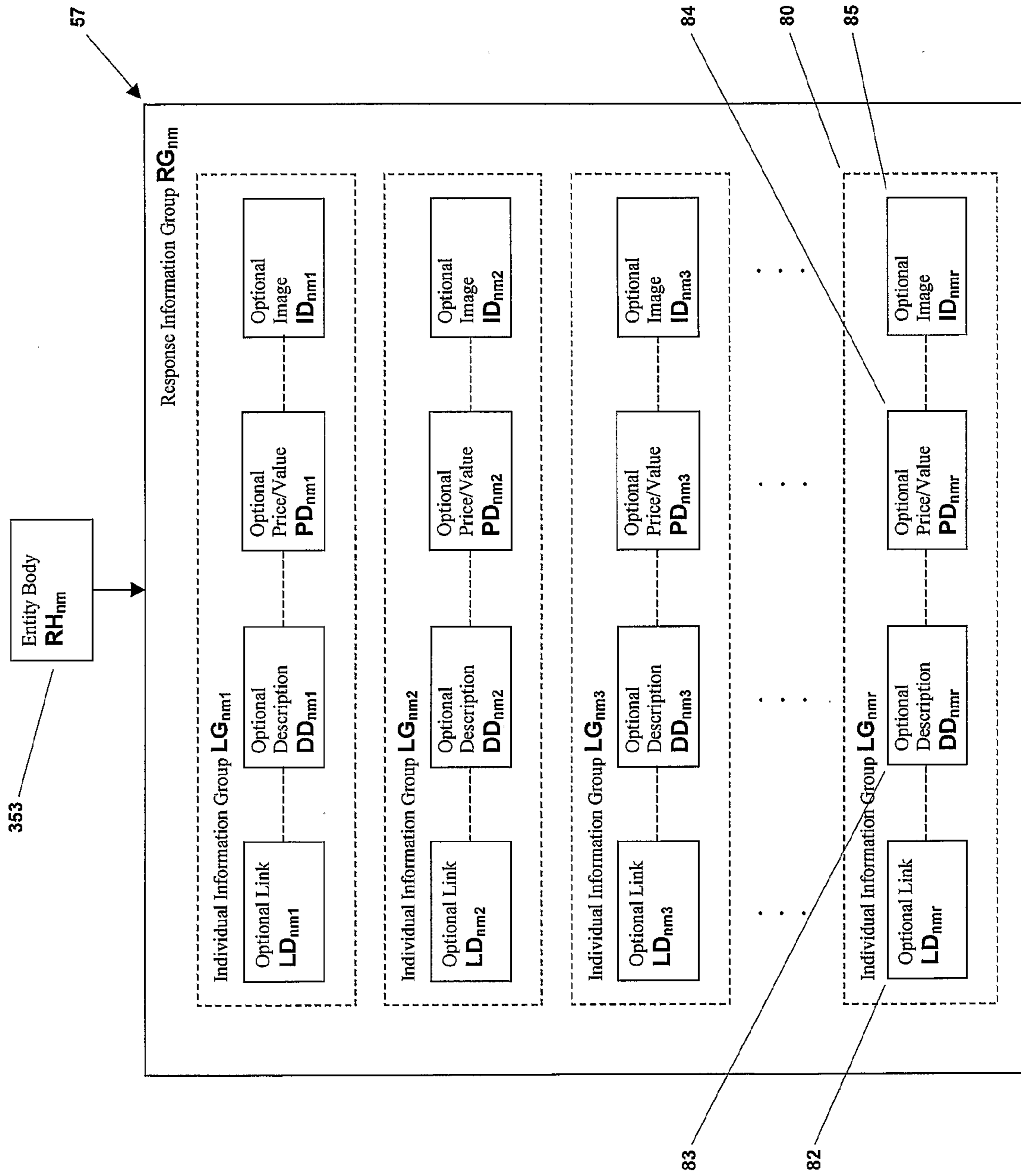

FIG. 37

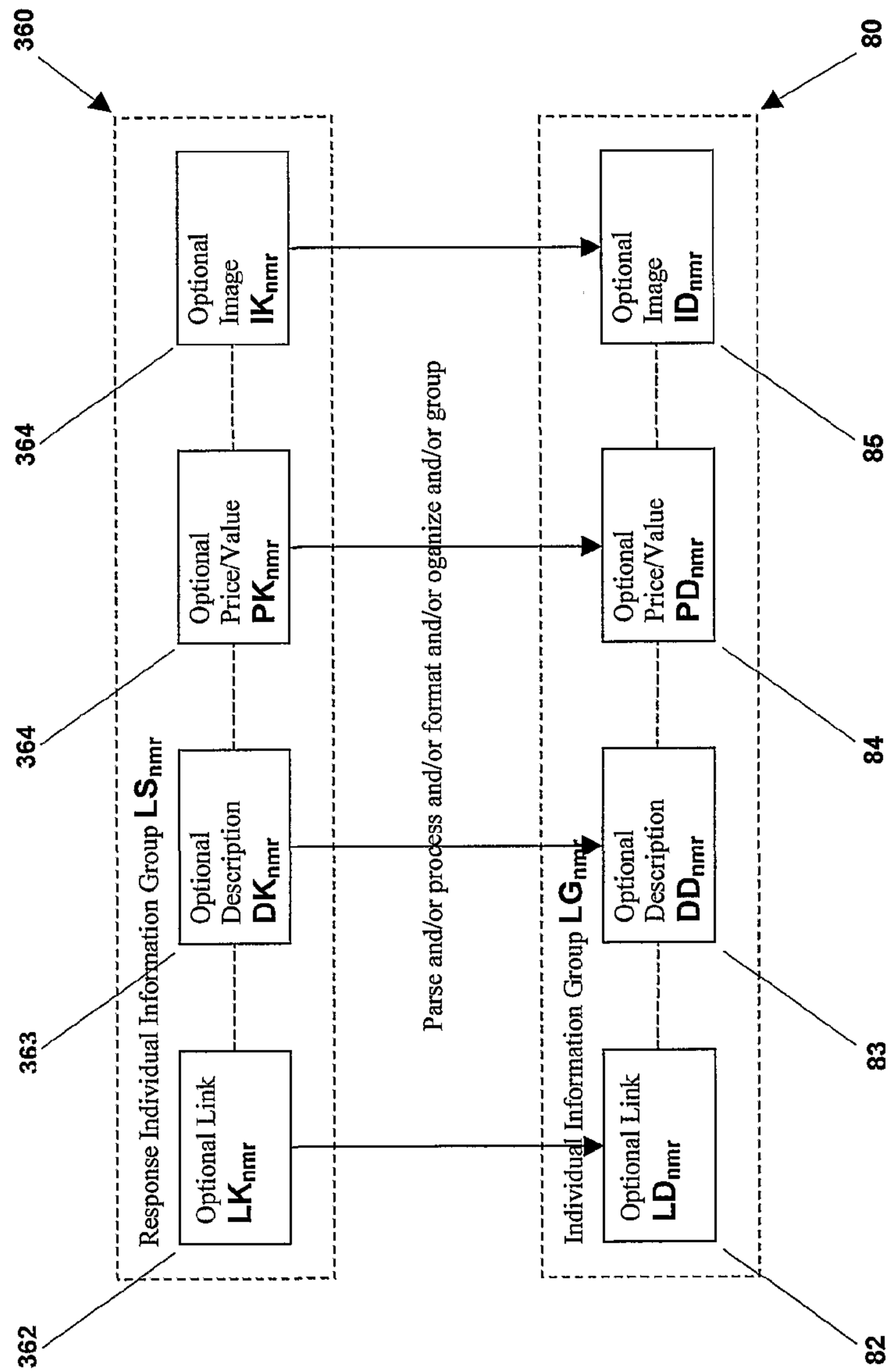

FIG. 38

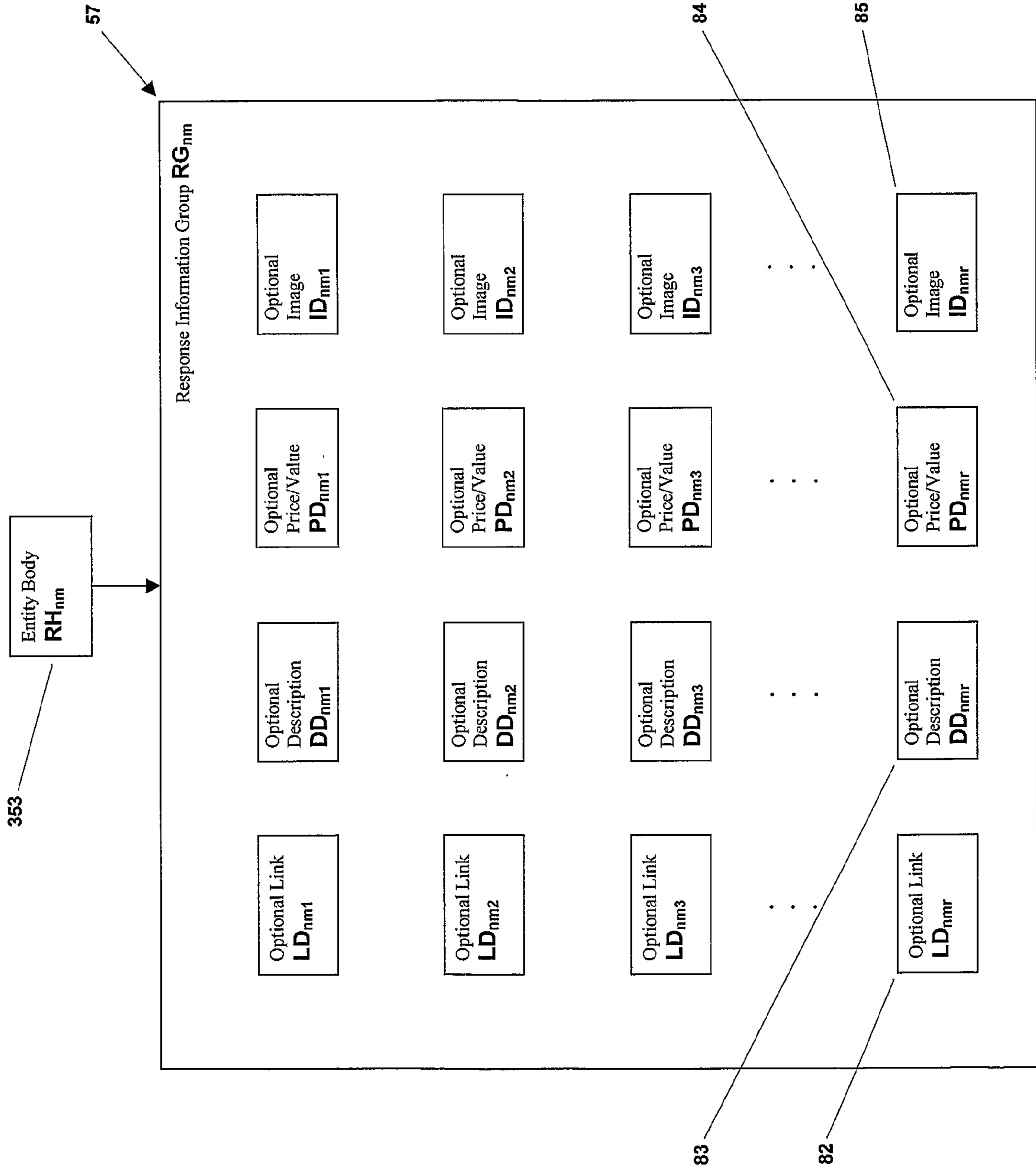

FIG. 39

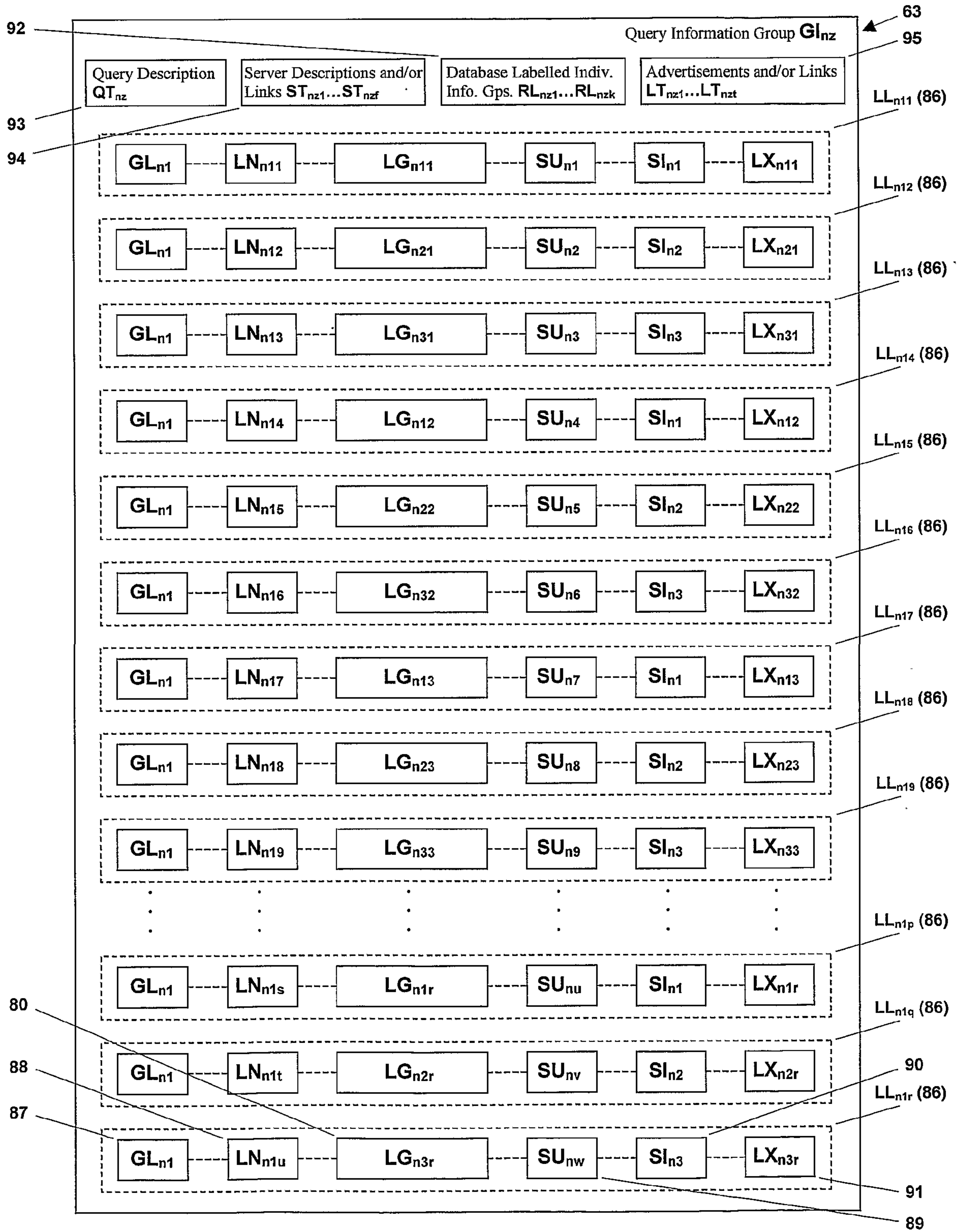

FIG. 40

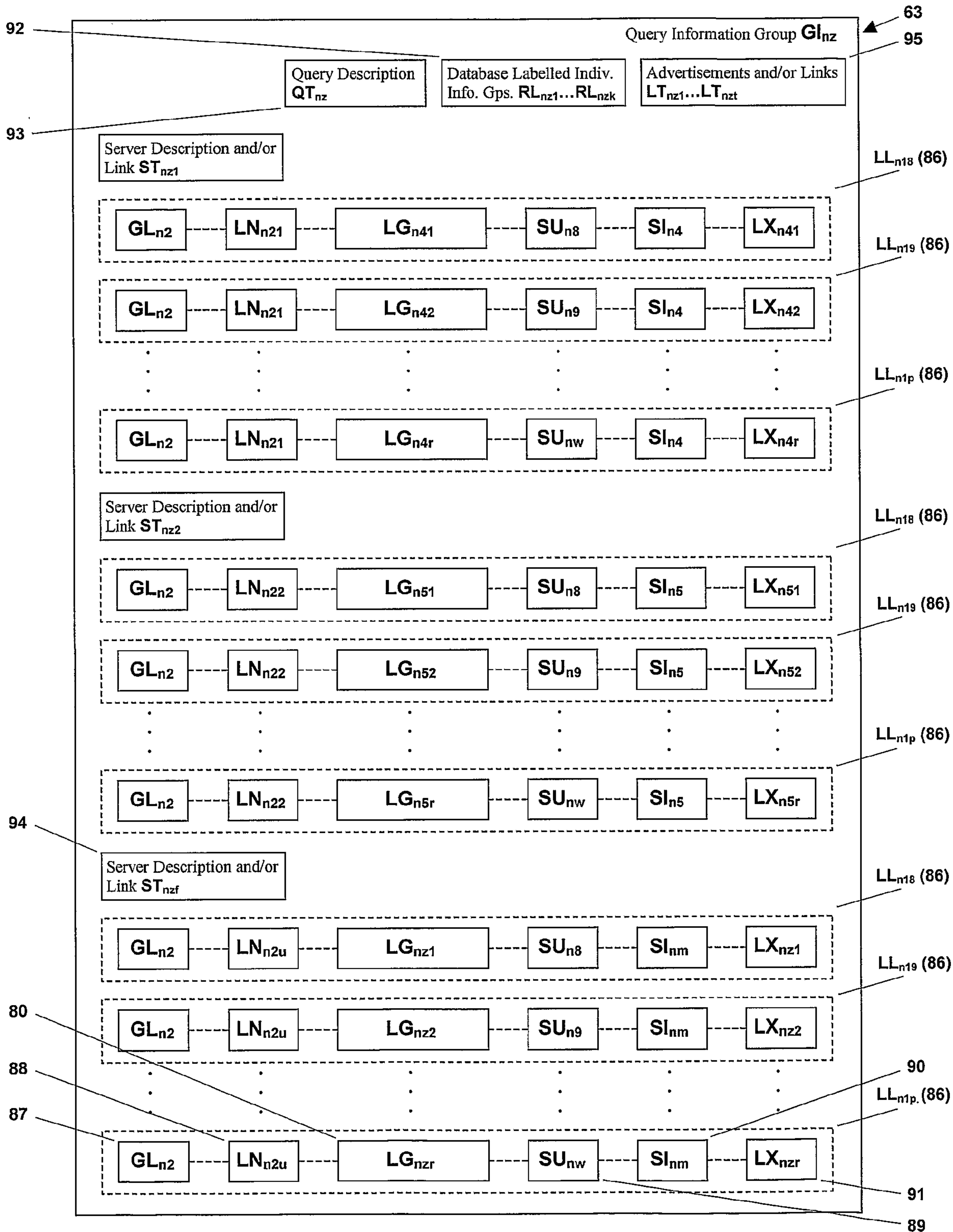



FIG. 41



Look4itHere

- Discovery**
[Disney](#), [Warner](#), [ABC](#),
[Universal](#), [CBS](#), [NBC](#)
- Hot Wired**
[E!Online](#), [Riddler](#)
- TV Guide**
[Reel.com](#), [MusicBlvd](#),
[RealAudio](#), [AudioNet](#)
- BuyerSellers**
[Ebay](#), [DrugStore](#),
[ShopNow](#), [Vitamin](#)
- CIA Kids**
[eToys](#), [KBkids](#), [Pets](#),
[ToysRus](#), [PetSmart](#)
- Family**
[BlueMount](#), [Women](#),
[Village](#), [Epicurious](#)
- Weather**
[Intellicast](#), [MapQuest](#)
- CitySearch**
[555-1212](#), [Travelocity](#),
[Fodor's](#), [LeisurePlan](#)
- ESPN**
[SportsLine](#), [NFL](#), [NBA](#),
[SmallWorld](#), [NHL](#)
- CNN**
[NYTimes](#), [WSJournal](#),
[USAtoday](#), [ABCnews](#)
- StockMaster**
[CNNfn](#), [Bloomberg](#),
[DowJones](#), [Quote](#)
- CNet**
[ZDNet](#), [CMPnet](#), [IDG](#),
[Outpost](#), [Jumbo](#)
- Monster Board**
[JobBank](#), [BestJobs](#),
[Career](#), [Incpad](#), [Inll](#)

Search'em All: Search your favorite search engines, all at the same time*

Search 1:	<input type="text"/>	WebCrawler	▼
Search 2:	<input type="text"/>	Altavista	▼
Search 3:	<input type="text"/>	Lycos	▼
Search 4:	<input type="text"/>	Infoseek	▼
Search 5:	<input type="text"/>	Excite	▼
Search 6:	<input type="text"/>	Yahoo	▼
Search 7:	<input type="text"/>	LookSmart	▼
Search 8:	<input type="text"/>	HotBot	▼
Search 9:	<input type="text"/>	Dejanews	▼

Search Engine Results: ▼ URL's per Search Engine:

URL Details: ▼ Timeout (seconds) per Search Engine:

Page: Searches per Group: Group: * Only 1 entry required

Search'em All: multiple simultaneous same* or different searches

<ul style="list-style-type: none"> Autos Buy, Cars, Racing Business Investments, Funds, Companies, Industry Careers Jobs, Universities, Education Entertainment Movies, Music, TV, Games, Chat 	<ul style="list-style-type: none"> Fashion Designers, Style, Models Health Drugs, Diseases, News Homes Food, Wine, Gardening Issues Government, Politics, Taxes, Editorials People Relationships, Dating, Psychology 	<ul style="list-style-type: none"> Society Philosophy, Economics, Religion, Sociology Sports Baseball, Basketball, Football, Hockey Technology Computers, Environment, Engineering, Internet Travel Maps, Vacations, Fares
--	--	--

Flowers for your Valentine
[itd.com](#)
NOW easy ordering at
N Netscape
Netcenter
[Click Here...](#)

netMarket Auction
VCR Spectacular

Bids start at 1
[Click Now!](#)

February 6, 1998
NEWS ABC NEWS Headlines
U.S. Presence Growing in Iraq

Look4itHere
Div. of Internet Corporation

- [News](#)
- [Weather](#)
- [Cool Sites](#)
- [Shopping](#)
- [Contests](#)
- [Horoscopes](#)
- [Classified](#)

Phone: 1-831-757-1600 · E-Mail: look4itthere@look4itthere.com · Internet Corporation

FIG. 42



Look4itHere

Discovery
[Disney](#), [Warner](#), [ABC](#),
[Universal](#), [CBS](#), [NBC](#)

Hot Wired
[E!Online](#), [Riddler](#)

TV Guide
[Reel.com](#), [MusicBlvd](#),
[RealAudio](#), [AudioNet](#)

BuyerSellers
[Ebay](#), [DrugStore](#),
[ShopNow](#), [Vitamin](#)

CIA Kids
[eToys](#), [KBkids](#), [Pets](#),
[ToysRus](#), [PetSmart](#)

Family
[BlueMount](#), [Women](#),
[Village](#), [Epicurious](#)

Weather
[Intellicast](#), [MapQuest](#)

CitySearch
[555-1212](#), [Travelocity](#),
[Fodor's](#), [LeisurePlan](#)

ESPN
[SportsLine](#), [NFL](#), [NBA](#),
[SmallWorld](#), [NHL](#)

CNN
[NYTimes](#), [WSJournal](#),
[USAtoday](#), [ABCnews](#)

StockMaster
[CNNfn](#), [Bloomberg](#),
[DowJones](#), [Quote](#)

CNet
[ZDNet](#), [CMPnet](#), [IDG](#),
[Outpost](#), [Jumbo](#)

Monster Board
[JobBank](#), [BestJobs](#),
[Career](#), [Incpad](#), [Intl](#)

Search'em All: Search your favorite search engines, all at the same time*

Search 1: <input type="text" value="Cat"/>	<input type="text" value="WebCrawler"/>
Search 2: <input type="text" value="Cat"/>	<input type="text" value="Altavista"/>
Search 3: <input type="text" value="Cat"/>	<input type="text" value="Lycos"/>
Search 4: <input type="text" value="Mouse"/>	<input type="text" value="Infoseek"/>
Search 5: <input type="text" value="Dog"/>	<input type="text" value="Excite"/>
Search 6: <input type="text" value="Dog"/>	<input type="text" value="Yahoo"/>
Search 7: <input type="text" value="Mouse"/>	<input type="text" value="LookSmart"/>
Search 8: <input type="text" value="Dog"/>	<input type="text" value="HotBot"/>
Search 9: <input type="text" value="Cat"/>	<input type="text" value="Dejanews"/>

Search Engine Results: URL's per Search Engine:

URL Details: Timeout (seconds) per Search Engine:

Page: Searches per Group: Group: * Only 1 entry required

Search'em All: multiple simultaneous same* or different searches

<ul style="list-style-type: none"> • Autos Buy, Cars, Racing • Business Investments, Funds, Companies, Industry • Careers Jobs, Universities, Education • Entertainment Movies, Music, TV, Games, Chat 	<ul style="list-style-type: none"> • Fashion Designers, Style, Models • Health Drugs, Diseases, News • Homes Food, Wine, Gardening • Issues Government, Politics, Taxes, Editorials • People Relationships, Dating, Psychology 	<ul style="list-style-type: none"> • Society Philosophy, Economics, Religion, Sociology • Sports Baseball, Basketball, Football, Hockey • Technology Computers, Environment, Engineering, Internet • Travel Maps, Vacations, Fares
---	---	---

Flowers for your Valentine
[std.com](#)
 NOW easy ordering at

 Click Here...

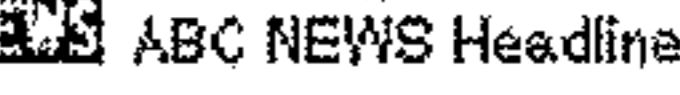
netMarket Auction VCR Spectacular

 Bids start at \$1
 Click Now!

February 6, 1998
 ABC NEWS Headlines
 U.S. Presence Growing in Iraq

Look4itHere
 Div. of Internet Corporation

[News](#) [Weather](#) [Cool Sites](#) [Shopping](#)
[Contests](#) [Horoscopes](#) [Classified](#)

Phone: 1-631-757-1600 • E-Mail: look4itthere@look4itthere.com • Internet Corporation

FIG. 43

FIG. 44

Look4ItHere

Discovery
[Disney](#), [Warner](#), [ABC](#),
[Universal](#), [CBS](#), [NBC](#)

Hot Wired
[E!Online](#), [Riddler](#)

TV Guide
[Reel.com](#), [MusicBlyd](#),
[RealAudio](#), [AudioNet](#)

BuyerSellers
[Ebay](#), [DrugStore](#),
[ShopNow](#), [Vitamin](#)

CIA Kids
[eToys](#), [KBkids](#), [Pets](#),
[ToysRus](#), [PetSmart](#)

Family
[BlueMount](#), [Women](#),
[Village](#), [Epicurious](#)

Weather
[Intellcast](#), [MapQuest](#)

CitySearch
[555-1212](#), [Travelocity](#),
[Fodor's](#), [LeisurePlan](#)

ESPN
[SportsLine](#), [NFL](#), [NBA](#),
[SmallWorld](#), [NHL](#)

CNN
[NYTimes](#), [WSJournal](#),
[USAtoday](#), [ABCNews](#)

StockMaster
[CNNfn](#), [Bloomberg](#),
[DowJones](#), [Quote](#)

CNet
[ZDNet](#), [CMPnet](#), [IDG](#),
[Outpost](#), [Jumbo](#)

Monster Board
[JobBank](#), [BestJobs](#),
[Career](#), [Incpad](#), [Intl](#)

Search'em All: Search your favorite search engines, all at the same time!

Search 1:

Search 2:

Search 3:

Search 4:

Search 5:

Search 6:

Search 7:

Search 8:

Search 9:

Search Engine Results: URL's per Search Engine:

URL Details: Timeout (seconds) per Search Engine:

Page: Searches per Group: Group: * Only 1 entry required

Search Engine Report
Query: Cat

D) 1) Cats at Acme Pet - Cats, Feline, Cat Health, Cat Care
 Cats - A source of information for people interested in pedigreed and non-pedigreed cats. Information on cat care, feline welfare/rescue. Chats, bulletin boards, moderated discussions with feline profe...
<http://www.acmepet.com/feline/index.html> (webcrawler 1)

D) 2) Cat Fanciers Web Site
 The Internet forum for the cat fancy since 1993. Comprehensive site with lots of original content. Articles and links on cat breeds, cat shows, cat...
<http://www.fanciers.com/> (altavista 1)

D) 3) Arctic Cat Inc.-Snowmobiles
 Manufacture of Arctic Cat Snowmobiles. Links to product lineup, accessories, corporate information...
<http://www.arctic-cat.com/snowmobiles/index.html> (lycos 1)

D) 4) Cat facts and cat opinions by Precious The Cat
 Interesting facts about cats. Entertaining opinions of Precious The Cat ...
<http://www.hot1.net/cat/> (webcrawler 2)

D) 5) Feral Cat Coalition
 Large amounts of information of critical interest to those dealing with, or interested in, feral cats....
<http://www.feralcat.com/> (altavista 2)

D) 6) Pouncerstone Cat Care And Cat Stories
 Provides information, reference sources and recommended books on general cat care, feline kidney disease, and cat stories for pleasure reading....
<http://www.pouncerstone.com> (lycos 2)

D) 7) Misty & Pickles' Cat Page
 Welcome to Misty & Pickles' Cat Page, dedicated to all cats. Misty & Pickles created this site so that cats and cat lovers could learn more about these fascinating creatures, earn awards, visit other c...
<http://www.linet.net.au/~waller/Cats/> (webcrawler 3)

D) 8) Cat Stevens . Com - The Cat Stevens World Wide Web Site
 Your complete source for everything Cat Stevens and Yusuf Islam...
<http://www.catstevens.com/> (altavista 3)

D) 9) Cat Whisker Digest
 For would-be, novice and experienced cat whisker collectors, cat fans, and feline friends...
<http://members.mint.net/kinzel/cat1.html> (lycos 3)

D) 10) Feline Information Page
 SOCKS: The First Cat Last Updated: October 13, 1999 See The Awards This Page Has Won! You are the 397,446th person here! Welcome to the wonderful world of cats! ...
<http://www.best.com/~sirlou/cat.shtml> (webcrawler 4)

D) 11) > Laughing Cat Records <
 Laughing Cat Records. Laughing Cat Records specializes in CD and Cassette releases of New Age, Native American, Folk, Reggae and Experimental music....
<http://www.lafcat.com/> (altavista 4)

D) 12) The Cat's Voice
 Information Exchange for people who care about cats. The Cat's Voice supports non-profit, no-kill volunteer pet rescue groups. Includes a cat naming database ... add your favorite name fo...
<http://sampsongdesign.com/voice/> (lycos 4)

D) 13) Bengal cat magazine ...: bengalcat.co.uk ...
 bengalcat.co.uk provides a wealth of information, for beginners and experts alike, about the exotic Bengal cat ...
<http://www.bengalcat.co.uk/> (webcrawler 5)

D) 14) The American Cat Fanciers Association
 American Cat Fanciers Association. "Seraphina Taffy of Taffykats" Brown Tabby Particolor Norwegian Forest Cat Spay 1999 Best InterAmerican Alter...
<http://www.ecfacat.com/> (altavista 5)

D) 15) Cat's Cradle. The

Flowers for your Valentine
[std.com](#)
 NOW easy ordering at
Netscape Netcenter
 Click Here...

netMarket Auction VCR Spectacular
Bids start at 1
 Click Now!

February 6, 1998
NEWS ABC NEWS Headlines
 U.S. Presence Growing in Iraq

The Cat's Cradle is an exclusive CAT HOTEL and retail shop located in Las Vegas, Nevada...
http://www.kittycamp.com (lycos 5)

I) 16) Pavlov's Cat Scratch Feeder

Pavlov's Cat Scratch Feeder: There is no comparable product Pet Product Manufacturers/Distributors:
Product owner desires to transfer Product ...
http://www.mktmkt.com/pavlovsat.html (webcrawler 6)

I) 17) Cat Ring

The Original Cat Ring is a large group of sites with substantial content related to the domesticated cat...
...
http://www.xmission.com/~emailbox/catring.html (altavista 6)

I) 18) Cat-E-Corner.com

Virtual community for cat lovers with articles on health, breeds, care, and safety....
http://www.cat-e-corner.com (lycos 6)

I) 19) Cat Fanciers' Association: Breed Profile: Maine Coon

An indepth look into the Maine Coon breed, the native American longhaired cat ...
http://www.cfainc.org/breeds/profiles/maine.html (webcrawler 7)

I) 20) Cat's Eye | Chatoyant

Cat's Eye/Chatoyant is a press for the digital age. In concert with our website production services, we
design products and market them through our... ..
http://www.catseyepress.com/ (altavista 7)

I) 21) All Cat Furniture

Cats-At-Play sells some of the most exquisite cat furniture, cat scratching posts, cat condos, cat stands
and cat trees for your cat's enjoyment...
http://www.catsatplay.com/Default.htm (lycos 7)

I) 22) The Cat Kingdom

Welcome to the Cat Page! Hi! My name is Jess and this is my cat web page. This is a picture of my cat,
Pepper. He is a nine-year-old, black, domestic shorthair that is very spoiled. ...
http://www.voicenet.com/~billpie/cat/ (webcrawler 8)

I) 23) Cat Tales Home Page

LATEST UPDATE: January 22, 2000. Bookmark this page now because you will want to come back
often.... Ca. t Tales Zoological P. ark. As seen on... ..
http://www.cattales.org/ (altavista 8)

I) 24) Alley Cat Allies

The home page of Alley Cat Allies: promoting compassion and humane care for America's feral cat
population...
http://www.alleycat.org/ (lycos 8)

I) 25) cat picture stories cat picture Pictures!

The Hardest Adult cat picture Site On The Net!!! REAL Pix, Horny Studs cat picture Videos, Live Chat
Rooms, Live Stud Cam. Horny Studs Want To Make You Cum... cat picture I! ...
http://baasts.dicksucking.com/ (webcrawler 9)

I) 26) The International Bengal Cat Society

The International Bengal Cat Society presents the new breed of spotted domestic cat with wild Asian
Leopard Cat ancestors. Pictures, breeders,
http://www.bengalcat.com/ (altavista 9)

I) 27) Christine's Cat Graphics

Cat background border sets for your web site. Includes Victorian cat sets, cat photo sets, and cat
silhouette sets....
http://www.geocities.com/%7ecccats/creations/ (lycos 9)

I) 28) Kitty clinic helps pet owners find remedies for their troubled Toms ...

...
http://detnews.com:80/2000/features/0002/09/02090083.htm (webcrawler 10)

I) 29) Fat Cat, Inc. 2000

We're a company dedicated to making the cats of the world happy -- oh, and we make cat toys too! Us.
Info. Products. Fun. You. Home. Contact Fat... ..
http://www.fatcats.com/ (altavista 10)

I) 30) Second opinion? Try searching for "Cat" at

...
http://www.lycos.com/hotbot-redirect.html?query=Cat (lycos 10)

Look4itHere
Div. of Internet Corporation

- News
- Contests
- Weather
- Horoscopes
- Cool Sites
- Classified
- Shopping

Visit Look4itHere2

Phone: 1-631-757-1600 · E-Mail: look4ithere@look4ithere.com
Internet Corporation

Current Group: I			Next Group: II			Group: III		
webcrawler1	altavista2	lycos3	infoseek4	excite5	yahoo6	looksmart7	hotbot8	dejanews9
Cat	Cat	Cat	Mouse	Dog	Dog	Mouse	Dog	Cat
Go to page: 1 2 3 4 5 6 7 8 9 10 Go to: [Next Page]								
11 12 13 14 15 16 17 18 19 20								
21 22 23 24 25								
Search Display (interleaved or separately by search engine): [Separate]								
Description or List (Site descriptions or lists): [List]								

FIG. 45

Look4itHere

Search on All Search your favorite search engines all at the same time

Search 1: WebCrawler

Search 2: Altavista

Search 3: Lycos

Search 4: Infoseek

Search 5: Excite

Search 6: Yahoo

Search 7: LookSmart

Search 8: HotBot

Search 9: Dejanews

Search Engine Results: URLs per Search Engine:

URL Defaults: Timeout (seconds) per Search Engine:

Page: Searches per Group: Group:

Discovery
Disney, Warner, ABC, Universal, CBS, NBC

Hot Wired
E! Online, Riddler

TV Guide
Real.com, MusicBvd, RealAudio, AudioNet

Buyer Sellers
eBay, DrugStore, ShopNow, Vitamin

CIA Kids
eToys, KBKids, Pets, ToysRus, PetSmart

Family
BlueMountain, Women, Village, Edutube

Weather
Intellias, MapQuest

City Search
555-1212, Travelocity, Fodor's, LeisurePlan

ESPN
Sportsline, NFL, NBA, SmallWorld, NHL

CNN
NYTimes, WSJ, USA Today, ABC News

StockMaster
CNN, Bloomberg, Dow Jones, Quote

CNet
ZDNet, CMP, JDO, Outpost, Jumbo

Monster Board
JobBank, EssJobs, Career, Incipad, Hiji

Search Engine Report
Query: Mouse

II) 1) Rat and Mouse Club of America
Past newsletter articles, rodent-friendly vets, and links to rat and mice sites on the Internet....
<http://www.rmca.org/> (Infoseek 1)

II) 2) Mouse Systems
The first company Steve Kirsch founded, and it's still thriving. Makers of joysticks, keyboards, mice and trackballs....
<http://www.mousesystems.com/> (Infoseek 2)

II) 3) Christmas Mouse
Christmas ornaments, Christmas decorations, gifts and collectibles....
<http://www.christmasmouse.com/> (Infoseek 3)

II) 4) The Door Mouse - Bettsville, Ohio
a modern country quilt shop, online catalog with secure transactions, 5000 fabrics including Hoffmans, Kona Bays, Benartex, P&B, Hi-Fashion, flannels, clothing, kits, tops, free pattern, friendly perso...
<http://www.thedoormouse.com/> (Infoseek 4)

II) 5) Dancing Mouse Studios -- Backgrounds, Buttons, and Other Web Graphics
Free web graphics -- backgrounds, buttons, and lines...
<http://www.dancingmouse.com/> (Infoseek 5)

II) 6) Mouse
Para ver este sitio necesita un navegador que pueda desplegar marcos (frames). Le recomendamos actualizar su navegador (Ej.: Netscape Communicator 4.0 o superior, Internet Explorer 4.0 o superior) View...
<http://www.copesa.cl/mouse/> (Infoseek 6)

II) 7) MGI Home Page
Use % as wildcard Information and Help Data and Nomenclature Submissions Mouse Facts MGI User Survey User Support User Documentation Electronic Bulletin Boards Tools for Software Developers Bioinformat...
<http://mgd.nia.affrc.go.jp/> (Infoseek 7)

II) 8) The Mouse Hole: Java Fun for All Ages!
Thanks to JavaScript World for making this page possible Back to the texnews.com ... Reality Bytes ... Underground Howl...
<http://www.texnews.com/hole/index.html> (Infoseek 8)

II) 9) - Mouse Marketing Inc. -
Oct. 27, 1999 A draft from an open front window cuts across the offices, scattering dust into the sunlight. Two completely different projects are being discussed simultaneously, hovering above a pillow...
<http://www.mousemarketing.com/> (Infoseek 9)

II) 10) ABC.com
...
<http://abc.go.com> (Infoseek 10)

Query: Dog

II) 1) dogs - dog training - dog behavior - dog adoption
Digitaldog offers dog training and breeding information, and provides information on adopting dogs from animal shelters. ...
[http://search.excite.com/relocate/sr=webresull\[ss=Dog\]\[d=283089,h...](http://search.excite.com/relocate/sr=webresull[ss=Dog][d=283089,h...) (excite 1)

II) 2) Business and Economy > Companies > Animals > Dogs > Supplies, Equipment, and Gifts
...
http://dir.yahoo.com/Business_and_Economy/Companies/Animals/Dogs/... (yahoo 1)

II) 3) DogOwners.Com - Web Pages about Dogs
DogOwners.Com has a large variety of webpages about dogs including information on different dog breeds, puppies, dog newsgroups & chatrooms, dog health, pet supplies, dog names & dog humor. ...
[http://search.excite.com/relocate/sr=webresull\[ss=Dog\]\[d=474207,h...](http://search.excite.com/relocate/sr=webresull[ss=Dog][d=474207,h...) (excite 2)

II) 4) Dog Dreams
specializes in ...
<http://www.dog-dreams.com/> (yahoo 2)

II) 5) DOG-PLAY - Fun with Your Dog

Flowers for your Valentine
NOW easy ordering at
Netscape Netcenter
Click Here..

netMarket Auction
VCR Spectacular
Bids start at \$1
Click Now!

February 6, 1999
NEWS ABC NEWS Headlines
U.S. Presence Growing in Iraq

38

63

All dogs welcome! Mixed breeds included. Great stuff to do with your dog. Learn about agility, animal assisted activities, flyball, pet visiting, and other activities including some that are probably n...
<http://search.excite.com/relocate/sr=webresultss=DogId=81946,ht...> (excite 3)

II) 6) Science > Biology > Zoology > Animals, Insects, and Pets > Mammals > Dogs > Sports and Activities
 ...
http://dir.yahoo.com/Science/Biology/Zoology/Animals__Insects__an... (yahoo 3)

II) 7) Dogz ONE! - Your first stop for dogs on the 'net'
 Dogz One, Your first stop for dogs, on the 'net! The Breeder's Exchange and ON-LINE Magazine, designed to promote you, your dogs, your web site, your dog related products & services and educating the g...
<http://search.excite.com/relocate/sr=webresultss=DogId=33377,ht...> (excite 4)

II) 8) Business and Economy > Companies > Animals > Supplies, Equipment, and Gifts
 ...
http://dir.yahoo.com/Business_and_Economy/Companies/Animals/Suppl... (yahoo 4)

II) 9) A Dog's Best Friend
 FREE PERSONALIZED BIRTHDAY CARD FOR YOUR DOG! Send us your dog's name, breed & birthday, along with his or her mailing address. We will make sure your dog receives a personalized greeting on that s...
<http://search.excite.com/relocate/sr=webresultss=DogId=431006,h...> (excite 5)

II) 10) Party Dog
 special line of ...
<http://www.party-dog.com/> (yahoo 5)

II) 11) dog
 See Live dog Thumbnail Gallery and dog Pics Inside for free! ...
<http://search.excite.com/relocate/sr=webresultss=DogId=2041349,...> (excite 6)

II) 12) Dog.com
 search ...
<http://www.dog.com/> (yahoo 6)

II) 13) Peter Stuart Session Photos
 Welcome to the new website! Update 9/15/99 REPORTS AND PICTURES FROM JAPAN: Day 1 | Day 2
 Hi, I'm Peter Stuart. Some of you may have wandered over here from the Dog's Eye View site, and others may be l...
<http://search.excite.com/relocate/sr=webresultss=DogId=261690,h...> (excite 7)

II) 14) Recreation > Outdoors > Hunting > Bird Dogs > Magazines
 ...
http://dir.yahoo.com/Recreation/Outdoors/Hunting/Bird_Dogs/Magezi... (yahoo 7)

II) 15) Spring Canine : Changing the dog you have into the dog you want
 Spring Canine is a where we turn the dog you have into the dog you want. By using several techniques, but focusing on Positive Reinforcement and clicker training, we use gentle methods to gently and qu...
<http://search.excite.com/relocate/sr=webresultss=DogId=419404,h...> (excite 8)

II) 16) Bird Dog News
 publication about bird hunting ...
<http://www.Bird-Dog-News.com/> (yahoo 8)

II) 17) Choosing the Perfect Dog
 CHOOSING THE PERFECT DOG Site best viewed in Internet Explorer HOME : How do I choose the perfect dog for me? Of course, finding a truly "perfect" dog would be like finding a truly "perf...
<http://search.excite.com/relocate/sr=webresultss=DogId=241670,h...> (excite 9)

II) 18) Science > Biology > Zoology > Animals, Insects, and Pets > Mammals > Dogs > Breeds > American Pit Bull Terrier
 ...
http://dir.yahoo.com/Science/Biology/Zoology/Animals__Insects__an... (yahoo 9)

II) 19) Sled Dog Central . - Your on-line sled dog advertising & Infor...
 sled dog advertising, information on mushing, skijoring, northern dogs, race schedules, race results, dog training ...
<http://search.excite.com/relocate/sr=webresultss=DogId=109558,h...> (excite 10)

II) 20) Sporting Dog Online
 comprehensive game bred American Pit Bull Terrier resource and home to the magazine "The Journal"...
<http://www.sporting-dog.com/> (yahoo 10)

Look4ItHere
 Div. of Internet Corporation
 News Contests Weather Horoscopes Cool Sites Shopping Classified
 Visit Look4ItHere2

Phone: 1-631-757-1600 - E-Mail: look4itthere@look4itthere.com - Internet Corporation

63

Previous Group: I			Current Group: II			Next Group: III		
webcrawler1	altavista2	lycos3	infoseek4	excite5	yahoo6	looksmart7	hotbot8	dejanews9
Cat	Cat	Cat	Mouse	Dog	Dog	Mouse	Dog	Cat

Go to page: 1 2 3 4 5 6 7 8 9 10 Go to: [Next Page]

11 12 13 14 15 16 17 18 19 20
 21 22 23 24 25

Search Display (Interleaved or separately by search engine): [Separate]
 Description or List (Site descriptions or lists): [List]

271

FIG. 46

Look4itHere

Discovery
[Disney, Warner, ABC](#)
[Universal, CBS, NBC](#)

Hot Wired
[E!Online, Riddler](#)

TV Guide
[Reel.com, MusicBlvd.](#)
[RealAudio, AudioNet](#)

BuyerSellers
[Ebay, DrugStore,](#)
[ShopNow, Vitamin](#)

CIA Kids
[eToys, KBkids, Pels,](#)
[ToysRus, PetSmart](#)

Family
[BlueMount, Women,](#)
[Village, Epicurious](#)

Weather
[Intellcast, MapQuest](#)

CitySearch
[555-1212, Travelocity,](#)
[Fodor's, LeisurePlan](#)

ESPN
[SportsLine, NFL, NBA,](#)
[SmallWorld, NHL](#)

CNN
[NYTimes, WSJournal,](#)
[USAtoday, ABCnews](#)

StockMaster
[CNNfn, Bloomberg,](#)
[DowJones, Quote](#)

CNet
[ZDNet, CMPnet, IDG,](#)
[Outpost, Jumbo](#)

Monster Board
[JobBank, BestJobs,](#)
[Career, Inopad, Inti](#)

Search'em All! Search your favorite search engines, all at the same time!

Search 1:	<input type="text"/>	WebCrawler
Search 2:	<input type="text"/>	Altavista
Search 3:	<input type="text"/>	Lycos
Search 4:	<input type="text"/>	Infoseek
Search 5:	<input type="text"/>	Excite
Search 6:	<input type="text"/>	Yahoo
Search 7:	<input type="text"/>	LookSmart
Search 8:	<input type="text"/>	HotBot
Search 9:	<input type="text"/>	Dejanews

Search Engine Results: URL's per Search Engine:

URL Details: Timeout (seconds) per Search Engine:

Page: Searches per Group: Group: * Only 1 entry required

Search Engine Report
Query: Mouse

III) 1) House-Mouse Designs - Mouse Pads
 These mouse pads bearing animations of cartoon mice are cute and a refreshing source of meta-humor. Also find magnets, notepads and other gifts...
<http://www.house-mouse.com/html/mousepads.html> (looksmart 1)

III) 2) Mouse House
 Creates custom mouse pads featuring your photos in both landscape and portrait formats. Print out an order form....
<http://www.mousehse.com/mouse.htm> (looksmart 2)

III) 3) Cozone - Mouse Pads
 Electronics and computer store stocks a mouse pad with a gel wrist rest and a Mickey Mouse combo unit. Includes a freight calculator....
http://www.cozone.com/cgi-bin/live/cozone/catalog/html/search_res... (looksmart 3)

III) 4) Equine Themed Computer Mouse Pads
 Equestrians and horse enthusiasts will enjoy this collection of mouse pads depicting rodeo, racing and polo scenes. With secure ordering....
http://www.horsenet.com/bookstable/equine_themed_computer_mouse_p... (looksmart 4)

III) 5) Leather Mouse Pad
 Front Street Leather handcrafts mouse pads out of genuine deerskin. Also find pouches and shoulder bags to buy online....
<http://www.frontstr.com/mouse-pad.htm> (looksmart 5)

III) 6) Warren Kimble - Calendar and Mouse Pads
 Fans of the American folk artist might enjoy these calendars and mouse pads for sale, including designs like "Colonial Flag" and "Round Barn"...
http://www.kimblehouse.com/cal_mouse.html (looksmart 6)

III) 7) CompuFun - Mouse Magic
 Discover a choice of non-traditional mouse pads including picture frames and double-sided pads, and order securely online....
<http://www.compufun1.com/mouse.htm> (looksmart 7)

III) 8) Mickey Mouse Club - Mickey Mouse Club Magazine
 Antiques mall features a few issues of the official Mickey Mouse Club Magazine from the 50s. View the covers, or get ordering information....
<http://www.the-forum.com/ephemera/disney6.htm> (looksmart 8)

III) 9) CompUSA - Mouse Pads
 Find out if a CompUSA near you stocks any of these mouse pads or gel wrist rest products....
http://www.compustores.com/products/products.asp?prodzip=&srch_... (looksmart 9)

III) 10) Flite Tech Leg Mounted Mouse Pad
 Unconventional mouse pad is designed to be strapped to the user's leg. Find reviews and an order form....
<http://www.ergomousepad.com/> (looksmart 10)

Query: Dog

III) 1) Welcome to Dog Owner's Guide!
 If you already have a dog, are considering adding one to your family or just plain like dogs, you've come to the right place for all kinds of information about dogs and how to live...
<http://www.canismajor.com/dog/gulde.html> (hotbot 1)

III) 2) AllDirect.com
 All Direct Books offers over 400,000 titles with 50% off selected bestsellers, 40% off most hardback books, 40% off most audio books, and 31-36% off most paperback books, delivered...
<http://alldirect.com/book.cfm?CartID=276539390021798> (hotbot 2)

III) 3) Dogs In Canada
 Order the 2000 Dogs Annual | About | Breeds Info | Features Upcoming | Webbits | Order | Subscribe | E-mail Pages authored for proper viewing with a JavaScript compliant...
<http://www.dogs-in-canada.com/> (hotbot 3)

III) 4) Dogs FAQ Index
 Dogs FAQ dogs-faq/acronym-list Subject: rec.pets.dogs: Complete List of Dog-Related Acronyms Maintainer: Cindy Tittle Moore rpd-info@netcom.com > FAQ Home Page: ...
<http://www.cis.ohio-state.edu/hypertext/faq/usenet/dogs-faq/top.h...> (hotbot 4)

III) 5) Von Der Hollenburg - German Shepherd Dogs and Puppies, German Shepherd Breeder
 A family owned kennel breeding QUALITY German Shepherd Dogs. We are a specialize in trained or

Flowers for your Valentine
[tda.com](#)
 NOW easy ordering at

 Click Here..

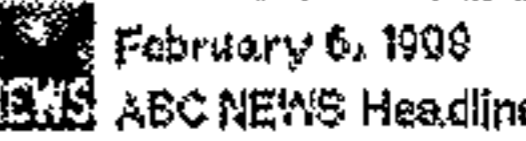
netMarket Auction
VCR Spectacular

Bids start at \$1
 Click Now!

February 6, 1998

 ABC NEWS Headlines
 U.S. Presence Growing In Iraq

untrained imported German Shepherd Dogs and German Shepherd Puppies...
http://www.vdhollenburg.com/ (hotbot 5)

III) 6) CyberPet - your source for pet information - dogs, cats breeders, pet products
CyberPet is your A-1 resource for pet information both on & for pet fanciers, exhibitors, breeders, dogs, cats, clubs, rescue, products, services, publications, informative...
http://www.cyberpet.com/ (hotbot 6)

III) 7) Dogs
General Dog Items Affenpinscher Afghan Hound Airedale Terrier Akita Alaskan Malamute American Eskimo American Staffordshire Terrier American Water Spaniel Anatolian Shepherd...
http://www.animalden.com/dogs.html (hotbot 7)

III) 8) dogs - dog training - dog behavior - dog adoption
Digitaldog offers dog training and breeding information, and provides information on adopting dogs from animal shelters....
http://www.digitaldog.com/index.html (hotbot 8)

III) 9) Dogs Worldwide
Dogs Worldwide - The Ultimate Showcase for the Canine World. Comprehensive guide to all things canine. Dogs Worldwide is The On-Line Magazine and Market Place for the Canine World...
http://www.dogsworldwide.com/ (hotbot 9)

III) 10) ABOUT Dogs One/INFO REQUEST FORM
Dogz One is a dog breeder's exchange and on-line magazine for people who love dogs. First of all, we are "dog" people. We own, train, breed, show,...and MOST importantly, LOVE our...
http://www.dogzone.com/aboutdz.htm (hotbot 10)

Query: Cat

III) 1) A gorgeous cat!
Forum: alt.animals.felines
Date: 2000/02/10 Author: Patrick Old ...
http://x39.deja.com/getdoc.xp?AN=583957026&CONTEXT=950219334.1007... (dejanews 1)

III) 2) Re: Cat Berlin 2008 Box
Forum: de.rec.music.hifi
Date: 2000/02/10 Author: Michael Töpperwien ...
http://x39.deja.com/getdoc.xp?AN=583954144&CONTEXT=950219334.1007... (dejanews 2)

III) 3) Re: cat on airplane
Forum: all.pets
Date: 2000/02/10 Author: Figgypie ...
http://x39.deja.com/getdoc.xp?AN=583932059&CONTEXT=950219334.1007... (dejanews 3)

III) 4) Re: Cat Skeleton for Gamma Rays
Forum: rec.arts.theatre.stagecraft
Date: 2000/02/10 Author: JAshby1041 ...
http://x39.deja.com/getdoc.xp?AN=584141171&CONTEXT=950219334.1007... (dejanews 4)

III) 5) Re: error catching
Forum: comp.soft-sys.matlab
Date: 2000/02/09 Author: Peter J. Acklam ...
http://x39.deja.com/getdoc.xp?AN=583653823&CONTEXT=950219334.1007... (dejanews 5)

III) 6) Re: help mv cat :o)
Forum: alt.bored
Date: 2000/02/08 Author: Kitzzy ...
http://x39.deja.com/getdoc.xp?AN=582801523&CONTEXT=950219334.1007... (dejanews 6)

III) 7) Re: new cat name
Forum: alt.gothic
Date: 2000/02/08 Author: Ectopy28 ...
http://x39.deja.com/getdoc.xp?AN=58333798&CONTEXT=950219334.1007... (dejanews 7)

III) 8) Say "I love you" to your cat in Irish.
Forum: soc.culture.irish
Date: 2000/02/10 Author: Plbrady ...
http://x39.deja.com/getdoc.xp?AN=584105901&CONTEXT=950219334.1007... (dejanews 8)

III) 9) Sick cat under house and won't come out
Forum: rec.pets.cats.health+behav
Date: 2000/02/10 Author: mariehal ...
http://x39.deja.com/getdoc.xp?AN=583924710&CONTEXT=950219334.1007... (dejanews 9)

III) 10) Spraying - female cat???
Forum: rec.pets.cats.health+behav
Date: 2000/02/10 Author: Teresa & Ralph ...
http://x39.deja.com/getdoc.xp?AN=583920960&CONTEXT=950219334.1007... (dejanews 10)

Look4itHere
Div. of Internet Corporation
News Contests Weather Horoscopes Cool Sites Shopping Classified
Visit Look4itHere?

Phone: 1-831-757-1600 • E-Mail: look4it@look4it.com • Internet Corporation

Group: I			Previous Group: II			Current Group: III		
webcrawler1	altavista2	lycos3	infoseek4	excite5	yahoo6	looksmart7	hotbot8	dejanews9
Cat	Cat	Cat	Mouse	Dog	Dog	Mouse	Dog	Cat
Go to page: 1 2 3 4 5 6 7 8 9 10 Go to: [Next Page]								
11 12 13 14 15 16 17 18 19 20								
21 22 23 24 25								
Search Display (Interleaved or separately by search engine): [Separate]								
Description or List (Site descriptions or lists): [List]								

Look4itHere

Discovery
[Disney](#), [Warner](#), [ABC](#),
[Universal](#), [CBS](#), [NBC](#)

Hot Wired
[E!Online](#), [Riddler](#)

TV Guide
[Reel.com](#), [MusicBlvd.](#),
[RealAudio](#), [AudioNet](#)

BuyerSellers
[Ebay](#), [DrugStore](#),
[ShopNow](#), [Vitamin](#)

CIA Kids
[eToys](#), [KBkids](#), [Pets](#),
[ToysRus](#), [PetSmart](#)

Family
[BlueMount](#), [Women](#),
[Village](#), [Epicurious](#)

Weather
[Intellicast](#), [MapQuest](#)

CitySearch
[555-1212](#), [Travelocity](#),
[Fodor's](#), [LeisurePlan](#)

ESPN
[SportsLine](#), [NFL](#), [NBA](#),
[SmallWorld](#), [NHL](#)

CNN
[NYTimes](#), [WSJournal](#),
[USAtoday](#), [ABCnews](#)

StockMaster
[CNNfn](#), [Bloomberg](#),
[DowJones](#), [Quote](#)

CNet
[ZDNet](#), [CMPnet](#), [IDG](#),
[Outpost](#), [Jumbo](#)

Monster Board
[JobBank](#), [BestJobs](#),
[Career](#), [Incpad](#), [Intl](#)

Search'em All: Search your favorite search engines, all at the same time*

Search 1:

Search 2:

Search 3:

Search 4:

Search 5:

Search 6:

Search 7:

Search 8:

Search 9:

Search Engine Results: URL's per Search Engine:

URL Details: Timeout (seconds) per Search Engine:

Page: Searches per Group: Group: * Only 1 entry required

Search'em All: multiple simultaneous same* or different searches

<ul style="list-style-type: none"> • Autos Buy, Cars, Racing • Business Investments, Funds, Companies, Industry • Careers Jobs, Universities, Education • Entertainment Movies, Music, TV, Games, Chat 	<ul style="list-style-type: none"> • Fashion Designers, Style, Models • Health Drugs, Diseases, News • Homes Food, Wine, Gardening • Issues Government, Politics, Taxes, Editorials • People Relationships, Dating, Psychology 	<ul style="list-style-type: none"> • Society Philosophy, Economics, Religion, Sociology • Sports Baseball, Basketball, Football, Hockey • Technology Computers, Environment, Engineering, Internet • Travel Maps, Vacations, Fares
---	---	---

Look4itHere
Div. of Internet Corporation

• News	• Weather	• Cool Sites	• Shopping
• Contests	• Horoscopes	• Classified	

Flowers for your Valentine
std.com
 NOW easy ordering at
Netscape Netcenter
[Click Here...](#)

netMarket Auction VCR Spectacular

Bids start at 1
[Click Now!](#)

February 6, 1998
NEWS ABC NEWS Headlines
 U.S. Presence Growing in Iraq

Phone: 1-631-757-1600 · E-Mail: look4itthere@look4itthere.com · Internet Corporation

FIG. 47

FIG. 48

Look4ItHere

Search engines: All Search your favorite search engines, all at the same time. Search

Search 1: WebCrawler
 Search 2: AltaVista
 Search 3: Lycos
 Search 4: InfoSeek
 Search 5: Excite
 Search 6: Yahoo
 Search 7: LookSmart
 Search 8: HotBot
 Search 9: Dejanews

Search Engine Results: URL's per Search Engine: 10
 URL Details: Summary Timeout (seconds) per Search Engine: 3
 Page: 1 Searches per Group: 3 Group: 1 *Only 1 entry required

Search Engine Report
 Query: Cat

I) 1) Cats FAQ Index
 Cats FAQ cats-faq/behavior Subject: rec.pets.cats: Problem Behaviors in Cats FAQ Maintainer: RPC FAQ Poster rpo-info@iname.com > FAQ Home Page...
<http://www.cs.ohio-state.edu/hypertext/faq/usenet/cats-faq/top.h> (hotbot 1)

I) 2) Cats at Acme Pet - Cats, Feline, Cat Health, Cat Care
 Cats - A source of information for people interested in pedigreed and non-pedigreed cats, information on cat care, feline welfare/rescue, Chats, bulletin boards, moderated discussions with feline professionals...
<http://www.somepet.com/feline/index.html> (webcrawler 1)

I) 3) The Cat Fanciers' Association (CFA)
 An informative insight into the world of pedigreed cats - with breed profiles, top cat photos, cat show schedule, health articles...
<http://www.cfausa.org/> (hotbot 2)

I) 4) Misty & Pickles' Cat Page
 Welcome to Misty & Pickles' Cat Page, dedicated to all cats. Misty & Pickles created this site so that cats and cat lovers could learn more about these fascinating creatures, earn awards, visit other cat-sites on the 'Net, and see many gorgeous pictures of Misty & Pickles, as well as their friends...
<http://www.inet.net.au/~weller/Cats/> (webcrawler 2)

I) 5) Cat facts and cat opinions by Precious The Cat
 Interesting facts about cats. Entertaining opinions of Precious The Cat...
<http://www.hot1.net/cat/> (hotbot 3)

I) 6) Feline Information Page
 SOCKS: The First Cat Last Updated: October 13, 1999 See The Awards This Page Has Won! You are the 397,446th person here! Welcome to the wonderful world of cats! ...
<http://www.best.com/~stlou/cat.shtml> (webcrawler 3)

I) 7) Cats!
 This applet mimics cat behavior. Use the two sliding scales to control whether the kitty will tend to: sleep (left) or play (right) purr (left) or meow (right) Or you can choose...
<http://tp.cs.indiana.edu/rylan/ejohnson/jav/eko/cat.htm> (hotbot 4)

I) 8) Bengal cat magazine ... bengalcat.co.uk ...
 bengalcat.co.uk provides a wealth of information, for beginners and experts alike, about the exotic Bengal cat...
<http://www.bengalcat.co.uk/> (webcrawler 4)

I) 9) CATS Home Page
 In the crusade to regain personal freedom and collective prosperity. Check out the "March on the Capitol" for Tax Reform website. See what some of the most influential voices for...
<http://cats.org/> (hotbot 5)

I) 10) Pavlov's Cat Scratch Feeder
 Pavlov's Cat Scratch Feeder. There is no comparable product Pet Product Manufacturers/Distributors: Product owner desires to transfer Product Licensing, Manufacturing, and Marketing Rights...
<http://www.mtknki.com/pavlovcats.html> (webcrawler 5)

Query: Dog

I) 1) Welcome to Dog Owner's Guide!
 If you already have a dog, are considering adding one to your family or just plain like dogs, you've come to the right place for all kinds of information about dogs and how to live...
<http://www.canismajor.com/dog/guide.html> (hotbot 1)

I) 2) AllDirect.com
 All Direct Books offers over 400,000 titles with 50% off selected bestsellers, 40% off most hardback books, 40% off most audio books, and 31-36% off most paperback books, delivered...
<http://alldirect.com/book.cfm?CartID=27653030021798> (hotbot 2)

I) 3) Dogs FAQ Index
 Dogs FAQ dogs-faq/acronym-list Subject: rec.pets.dogs: Complete List of Dog-Related Acronyms Maintainer: Cindy Tittle Moore < rpd-info@netcom.com > FAQ Home Page...
<http://www.cis.ohio-state.edu/hypertext/faq/usenet/dogs-faq/top.h> (hotbot 3)

I) 4) Dogs in Canada
 Order the 1999 Dogs Annual | About | Breeds Info | Features Upcoming | Webbits | Order | Subscribe | E-mail Pages authored for proper viewing with a JavaScript compliant browser...
<http://www.dogs-in-canada.com/> (hotbot 4)

I) 5) Von Der Hollenburg - German Shepherd Dogs and Puppies, German Shepherd Breeder
 A family owned kennel breeding QUALITY German Shepherd Dogs. We are a specialize in trained or untrained imported German Shepherd Dogs and German Shepherd Puppies...
<http://www.vdhollenburg.com/> (hotbot 5)

Look4ItHere
 News Contests Weather Horoscopes Cool Sites Shopping Classified

Phone: 1-831-757-1600 • E-Mail: look4it@look4it.com
 Internet Corporation

Current Group: I			Next Group: II			Group: III		
hotbot1	hotbot2	webcrawler3	webcrawler4	webcrawler5	yahoo6	looksmart7	dejanews8	dejanews9
Cat	Dog	Cat	Mouse	Dog	Dog	Mouse	Dog	Cat
Go to page: 1 2 3 4 5 6 7 8 9 10 Go to: [Next Page]								
11 12 13 14 15 16 17 18 19 20								
21 22 23 24 25 26 27 28 29 30								
31 32 33 34 35 36 37 38 39 40 41 42 43 44 45 46 47 48 49 50								
Search Display (interleaved or separately by search engine): [Separate]								
Description or List (Site descriptions or lists): [List]								

FIG. 49

Look4ItHere

Search 'em All: Search your favorite search engines, all at the same time! Search

Search 1: WebCrawler

Search 2: Altavista

Search 3: Lycos

Search 4: Infoseek

Search 5: Excite

Search 6: Yahoo

Search 7: LookSmart

Search 8: HotBot

Search 9: Dejanews

Search Engine Results: URLs per Search Engine:

URL Details: Timeout (seconds) per Search Engine:

Page: Searches per Group: Group: * Only 1 result requested

Search Engine Report
Query: Mouse

II) 1) Chris Knight's Danger Mouse Page
Danger Mouse GALORE!! ...
<http://www.thumtek.net/~corkignu/CM/pages/DMindex.htm> (webcrawler 1)

II) 2) NOHANDS MOUSE
Easy-to-use, intuitive foot-operated mouse developed to eliminate carpal tunnel syndrome ...
<http://www.footmouse.com/> (webcrawler 2)

II) 3) Welcome to Phoenix Public Library
To select an item, click the left mouse button while pointer is on top of any of the boxes. For help learning to use a mouse, press the PAGE DOWN key located on your keyboard until instructions appear ...
<http://pac.lib.ci.phoenix.az.us/enhanced/> (webcrawler 3)

II) 4) Logitech CORDLESS WHEEL MOUSE 3-BUTTON [WebShopper]
Logitech CORDLESS WHEEL MOUSE 3-BUTTON ...
http://www.log.net/red_99_49186.html (webcrawler 4)

II) 5) UNIVERSAL ERGONOMIC Lap Mouse Pad
Reduces tension Reduces Joint & muscle stress Work for hours - pain free Eliminates upper body fatigue Reduces injury to wrist Reduces injury to elbow ...
<http://householdgizmos.net/lapmousepads.html> (webcrawler 5)

Query: Dog

II) 1) dogs - dog training - dog behavior - dog adoption
Digitaldog offers dog training and breeding information, and provides information on adopting dogs from animal shelters ...
<http://www.digitaldog.com/index.html> (webcrawler 1)

II) 2) Business and Economy > Companies > Animals > Dogs > Supplies, Equipment, and Gifts
...
http://dir.yahoo.com/Business_and_Economy/Companies/Animals/Dogs/ (yahoo 1)

II) 3) The Dog Genome Project
The Dog Genome Project is a collaborative study involving scientists at the University of California, Berkeley, the University of Oregon, and the Fred Hutchinson Cancer Research Center ...
<http://mendel.berkeley.edu/dog.html> (webcrawler 2)

II) 4) Dog Dreams
specializes in ...
<http://www.dog-dreams.com/> (yahoo 2)

II) 5) ABOUT Dogs One! INFO REQUEST FORM
Dogz One is a dog breeder's exchange and on-line magazine for people who love dogs. First of all, we are "dog" people. We own, train, breed, show...and MOST importantly, LOVE our dogs ...
<http://www.dogzone.com/aboutdiz.htm> (webcrawler 3)

II) 6) Science > Biology > Zoology > Animals, Insects, and Pets > Mammals > Dogs > Sports and Activities
...
http://dir.yahoo.com/Science/Biology/Zoology/Animals_Insects_an (yahoo 3)

II) 7) TCS Hot Dog Page
The Societalpsychology of Hot Dogs Thank you for looking at the hot dog technoweenie site. There have been E-mail us at: tcs@roads.com And visit some of our other interesting pages ...
<http://www.roads.com/~tcs/hotdog/hotdog.html> (webcrawler 4)

II) 8) Dog-Play
Information on all the different activities you can do with your ...
<http://www.dog-play.com/> (yahoo 4)

II) 9) 2000 DOG NAMES: Naming your puppy
2000 suggestions for naming your puppy ...
<http://www.petrx.com/dognames/> (webcrawler 5)

II) 10) Business and Economy > Companies > Animals > Supplies, Equipment, and Gifts
...
http://dir.yahoo.com/Business_and_Economy/Companies/Animals/Suppl (yahoo 5)

Look4ItHere
News Weather Chat Sites Shopping
Contents Homepages Classified

Visit Look4It-Here?

Phone: 1-631-757-1600 · E-Mail: look4it@look4it.com
Internet Corporation

Previous Group: I	Current Group: II	Next Group: III
webcrawler1	hotbot2	webcrawler3
webcrawler4	webcrawler5	yahoo6
looksmart7	dejanews8	dejanews9
Cat	Cat	Cat
Mouse	Dog	Dog
Mouse	Dog	Cat
Go to page:	1 2 3 4 5 6 7 8 9 10	Go to: [Next Page]
	11 12 13 14 15 16 17 18 19 20	
	21 22 23 24 25 26 27 28 29 30	
	31 32 33 34 35 36 37 38 39 40 41 42 43 44 45 46 47 48 49 50	
Search Display (Interleaved or separately by search engine):	[Separate]	
Description or List (Site descriptions or lists):	[List]	

FIG. 50

Look4ItHere

Search Engine Report
Query: Mouse

III) 1) House-Mouse Designs - Mouse Pads
These mouse pads bearing animations of cartoon mice are cute and a refreshing source of meta-humor. Also find magnets, notepads and other gifts...
<http://www.house-mouse.com/html/mousepads.html> (looksmart 1)

III) 2) Mouse House
Creates custom mouse pads featuring your photos in both landscape and portrait formats. Print out an order form...
<http://www.mousehouse.com/mouse.html> (looksmart 2)

III) 3) Cozone - Mouse Pads
Electronics and computer store stocks a mouse pad with a gel wrist rest and a Mickey Mouse combo unit. Includes a freight calculator...
http://www.cozone.com/cgi-bin/live/cozone/catalog/html/search_res... (looksmart 3)

III) 4) Equine Themed Computer Mouse Pads
Equestrians and horse enthusiasts will enjoy this collection of mouse pads depicting rodeo, racing and polo scenes. With secure ordering...
http://www.horsenet.com/books/equine_themed_computer_mouse_p... (looksmart 4)

III) 5) Leather Mouse Pad
Front Street Leather handcrafts mouse pads out of genuine deerskin. Also find pouches and shoulder bags to buy online...
<http://www.frontstr.com/mouse-pad.htm> (looksmart 5)

Query: Dog

III) 1) I have a big dog
Forum: alt.sex.animals
Date: 2000/02/10 Author: Mycon41877 ...
<http://x40.deja.com/goldoc.xp?AN=583369766&CONTEXT=950220916.2031...> (dejanews 1)

III) 2) Re: be careful with your dog, if you got a dog or r gettin one, read this...
Forum: rec.music.phish
Date: 2000/02/09 Author: Ariseyou ...
<http://x40.deja.com/goldoc.xp?AN=58348203&CONTEXT=950220916.2031...> (dejanews 2)

III) 3) Re: be careful with your dog, if you got a dog or r gettin one, read this...
Forum: rec.music.phish
Date: 2000/02/09 Author: Heyheydave ...
<http://x40.deja.com/goldoc.xp?AN=583515362&CONTEXT=950220916.2031...> (dejanews 3)

III) 4) Re: dog log
Forum: rec.music.phish
Date: 2000/02/08 Author: Mule Panic ...
<http://x40.deja.com/goldoc.xp?AN=583277526&CONTEXT=950220916.2031...> (dejanews 4)

III) 5) Re: What breed of dog are you ??? (NPC)
Forum: rec.music.phish
Date: 2000/02/08 Author: SK Lull ...
<http://x40.deja.com/goldoc.xp?AN=582974168&CONTEXT=950220916.2031...> (dejanews 5)

Query: Cat

III) 1) Re: error catching
Forum: comp.soft-sys.mallab
Date: 2000/02/09 Author: Peter J. Acklam ...
<http://x39.deja.com/goldoc.xp?AN=583533823&CONTEXT=950220916.1789...> (dejanews 1)

III) 2) Re: help my cat :o)
Forum: all.bored
Date: 2000/02/08 Author: Kicy ...
<http://x39.deja.com/goldoc.xp?AN=582901623&CONTEXT=950220916.1789...> (dejanews 2)

III) 3) Re: new cat name
Forum: alt.gothic
Date: 2000/02/08 Author: Eclopy28 ...
<http://x39.deja.com/goldoc.xp?AN=583333798&CONTEXT=950220916.1783...> (dejanews 3)

III) 4) Sick cat under house and won't come out
Forum: rec.pets.cats.health-behav
Date: 2000/02/10 Author: marleahd ...
<http://x39.deja.com/goldoc.xp?AN=583924710&CONTEXT=950220916.1789...> (dejanews 4)

III) 5) Spraying - female cat???
Forum: rec.pets.cats.health-behav
Date: 2000/02/10 Author: Teresa & Ralph ...
<http://x39.deja.com/goldoc.xp?AN=583920960&CONTEXT=950220916.1789...> (dejanews 5)

Look4ItHere
Div. of Internet Corporation
- News - Weather - Cont Sites - Shopping
- Contests - Horoscopes - Classified
- Visit Lock4ItHere2

Phone: 1-831-757-1600 - E-Mail: look4it@lock4it.com
Internet Corporation

Group: I	Previous Group: II	Current Group: III
webcrawler1	webcrawler4	looksmart7
hotbot2	webcrawler5	dejanews8
webcrawler3	yahoo6	dejanews9
Cat	Mouse	Dog
Cat	Dog	Mouse
Cat	Dog	Cat

Go to page: 1 2 3 4 5 6 7 8 9 10 Go to: [Next Page!](#)

11 12 13 14 15 16 17 18 19 20
21 22 23 24 25 26 27 28 29 30
31 32 33 34 35 36 37 38 39 40 41 42 43 44 45 46 47 48 49

Search Display (interleaved or separately by search engine): [Separate](#)
Description or List (Site descriptions or lists): [List](#)



Look4itHere

Discovery
Disney, Warner, ABC, Universal, CBS, NBC

Hot Wired
E!Online, Riddler

TV Guide
Reel.com, MusicBlvd, RealAudio, AudioNet

BuyerSellers
Ebay, DrugStore, ShopNow, Vitamin

CIA Kids
eToys, KBkids, Pets, ToysRus, PetSmart

Family
BlueMount, Women, iVillage, Epicurious

Weather
Intellicast, MapQuest

CitySearch
555-1212, Travelocity, Fodor's, LeisurePlan

ESPN
SportsLine, NFL, NBA, SmallWorld, NHL

CNN
NYTimes, WSJournal, USAtoday, ABCnews

StockMaster
CNNfn, Bloomberg, DowJones, Quote

CNet
ZDNet, CMPnet, IDG, Outpost, Jumbo

Monster Board
JobBank, BestJobs, Career, Incpad, Intl

Search'em All: Search your favorite search engines, all at the same time*

Search 1:

Search 2:

Search 3:

Search 4:

Search 5:

Search 6:

Search 7:

Search 8:

Search 9:

Search Engine Results: URL's per Search Engine:

URL Details: Timeout (seconds) per Search Engine:

Page: Searches per Group: Group: * Only 1 entry required

Search'em All: multiple simultaneous same* or different searches

- **Autos**
Buy, Cars, Racing
- **Business**
Investments, Funds, Companies, Industry
- **Careers**
Jobs, Universities, Education
- **Entertainment**
Movies, Music, TV, Games, Chat
- **Fashion**
Designers, Style, Models
- **Health**
Drugs, Diseases, News
- **Homes**
Food, Wine, Gardening
- **Issues**
Government, Politics, Taxes, Editorials
- **People**
Relationships, Dating, Psychology
- **Society**
Philosophy, Economics, Religion, Sociology
- **Sports**
Baseball, Basketball, Football, Hockey.
- **Technology**
Computers, Environment, Engineering, Internet
- **Travel**
Maps, Vacations, Fares

Look4itHere
Div. of Internet Corporation

- [News](#)
- [Weather](#)
- [Cool Sites](#)
- [Shopping](#)
- [Contests](#)
- [Horoscopes](#)
- [Classified](#)

Flowers for your Valentine
std.com

NOW easy ordering at
Netscape Netcenter
[Click Here...](#)

netMarket Auction VCR Spectacular

Bids start at 1

Click Now!

February 6, 1998
NEWS ABC NEWS Headlines

U.S. Presence Growing in Iraq

Phone: 1-631-757-1600 · E-Mail: look4itthere@look4itthere.com · Internet Corporation

FIG. 51

FIG. 52

Look4It Here

Discovery
[Disney, Warner, ABC, Universal, CBS, NBC](#)

Hot Wired
[E!Online, Riddler](#)

TV Guide
[Reel.com, MusicBlvd, RealAudio, AudioNet](#)

BuyerSellers
[Ebay, DrugStore, ShopNow, Vitamin](#)

CIA Kids
[eToys, KBkids, Pets, ToysRus, PetSmart](#)

Family
[BlueMount, Women, Village, Epicurious](#)

Weather
[Intellcast, MapQuest](#)

CitySearch
[555-1212, Travelocity, Fodor's, LeisurePlan](#)

ESPN
[SportsLine, NFL, NBA, SmallWorld, NHL](#)

CNN
[NYTimes, WSJournal, USAtoday, ABCnews](#)

StockMaster
[CNNfn, Bloomberg, DowJones, Quote](#)

CNet
[ZDNet, CMPnet, IDG, Outpost, Jumbo](#)

Monster Board
[JobBank, BestJobs, Career, Incped, Inti](#)

Search'em All! Search your favorite search engines, all at the same time!

Search 1:

Search 2:

Search 3:

Search 4:

Search 5:

Search 6:

Search 7:

Search 8:

Search 9:

Search Engine Results: URL's per Search Engine:

URL Details: Timeout (seconds) per Search Engine:

Page: Searches per Group: Group: * Only 1 entry required

Search Engine 5: excite5
Query5: large+mammals

II) 19) The Pleistocene
 This mammoth, found in deposits in Russia, was one of the largest land mammals of the Pleistocene, the time period that spanned from 1.8 million to 11,000 years ago. ...
[http://search.excite.com/relocate/sr=webresult\[ss=large+mammals\]...](http://search.excite.com/relocate/sr=webresult[ss=large+mammals]...) (excite 19)

II) 20) Animal Info - Rare, Threatened and Endangered Mammals
 Biology, ecology, habitat, and status of rare, threatened and endangered species of mammals and information on their native countries: biodiversity, ecosystems, population, and land use ...
[http://search.excite.com/relocate/sr=webresult\[ss=large+mammals\]...](http://search.excite.com/relocate/sr=webresult[ss=large+mammals]...) (excite 20)

II) 21) Polar Bear @Biology - U0fS
 This site summarizes the research activities of Dr. Malcolm Ramsay (ramsay@duke.usask.ca) a faculty member of The Department of Biology at the University of Saskatchewan. ...
[http://saarch.excite.com/relocate/sr=webresult\[ss=large+mammals\]...](http://saarch.excite.com/relocate/sr=webresult[ss=large+mammals]...) (excite 21)

II) 22) MOONLIGHT PRODUCTIONS/LEE TEPLY-WHALES, DOLPHINS, OTHER MARINE MAM...
 MOONLIGHT PRODUCTIONS/LEE TEPLY-WHALES, DOLPHINS, OTHER MARINE MAMMALS
 Pacific Spotted Dolphins "THE PILOT WHALE INCIDENT" EFFECTS OF LOW FREQUENCY ACTIVE SONAR ON WHALES - New! ...
[http://search.excite.com/relocate/sr=webresult\[ss=large+mammals\]...](http://search.excite.com/relocate/sr=webresult[ss=large+mammals]...) (excite 22)

II) 23) center for coastal studies - a non-profit organization for research, c...
 center for coastal studies - a non-profit group for research, conservation, and education in the coastal and marine environments, humpbacks, right whales, cape cod, stellwagen bank ...
[http://search.excite.com/relocate/sr=webresult\[ss=large+mammals\]...](http://search.excite.com/relocate/sr=webresult[ss=large+mammals]...) (excite 23)

II) 24) welcome.htm
 nature & wildlife photos and images, photography of African mammals, lions, giraffe, zebras, baboon, pets, animals, animal behavior, blue ridge parkway, American flowers, butterflies, frogs, bears, zoology, bi...
[http://search.excite.com/relocate/sr=webresult\[ss=large+mammals\]...](http://search.excite.com/relocate/sr=webresult[ss=large+mammals]...) (excite 24)

II) 25) MMS Pacific - Marine Mammals & Seabirds
 The Pacific OCS Region has supported the collection of large amounts of information on the marine mammals and seabirds that live along the west coast of the United States. ...
[http://search.excite.com/relocate/sr=webresult\[ss=large+mammals\]...](http://search.excite.com/relocate/sr=webresult[ss=large+mammals]...) (excite 25)

II) 26) Home Page for The Mastiff
 The Mastiff is a giant-breed dog with a long history. Most people are first attracted to this breed by its massiveness, but do not realize that with a large dog may come large problems. ...
[http://search.excite.com/relocate/sr=webresult\[ss=large+mammals\]...](http://search.excite.com/relocate/sr=webresult[ss=large+mammals]...) (excite 26)

II) 27) K9netuk - Your window on the UK Dog Scene
 Top British Canine Site packed with information ...
[http://search.excite.com/relocate/sr=webresult\[ss=large+mammals\]...](http://search.excite.com/relocate/sr=webresult[ss=large+mammals]...) (excite 27)

II) 28) Dolphin Synergy
 a virtual journey into Dolphin Hyperspace Virtual Galleries of the photography of Daniel McCulloch
 Formulated for YOU ARE HERE Are You Ready for the Gateway Plexus? ...
[http://search.excite.com/relocate/sr=webresult\[ss=large+mammals\]...](http://search.excite.com/relocate/sr=webresult[ss=large+mammals]...) (excite 28)

II) 29) Dave's Genuine House O Nonsense
 Dave's House-O-Nonsense is the best Web Site ever. In fact, it has been known to make you popular at

Flowers for your Valentine
[vca.com](#)
 NOW easy ordering at
N Netscape Netcenter
 Click Here..

netMarket Auction
VCR Spectacular
 Bids start at
1
 Click Now!

February 6, 1998
NEWS ABC NEWS Headlines
 U.S. Presence Growing in Iraq

school and a hit with the ladies. And we all know we love that ...
<http://search.excite.com/relocate/sr=webresult|ss=large+mammals|j...> (excite 29)

II) 30) Tasmanian Devil: Small but Strong

The Tasmanian devil now lives only in Tasmania's forests and scrub areas, though it was once widespread over mainland Australia. This carnivorous marsupial has an exaggerated reputation for ferocity. ...

<http://search.excite.com/relocate/sr=webresult|ss=large+mammals|j...> (excite 30)

II) 31) The Bear Den--All About Bears

The Bear Den--Official Web Site of the Bear Taxon Advisory Group of the American Zoo & Aquarium Society ...

<http://search.excite.com/relocate/sr=webresult|ss=large+mammals|j...> (excite 31)

II) 32) mammals

ZINEZONE.com - The Home for TRAILBLAZERS everywhere. News, articles, facts - find it here!
 mammals

<http://search.excite.com/relocate/sr=webresult|ss=large+mammals|j...> (excite 32)

II) 33) Welcome to Frolic.org, Home of Christopher Feyrer and his Naked Dancin...

Welcome to www.frolic.org, Home of Naked Dancing Llama (tm) and his caretaker, Christopher Feyrer
 The Naked Dancing Llama (tm) NEW OFFICIAL LOCATION: <http://www.frolic.org/ndl.html>
 Award-winning, advic...

<http://search.excite.com/relocate/sr=webresult|ss=large+mammals|j...> (excite 33)

II) 34) index

Biology of Whales Welcome to Sarah's Webpage Whales are found in all of the world's oceans and even in some of the rivers. They live in saltwater or fresh, and can be found from the Arctic Circle to An...

<http://search.excite.com/relocate/sr=webresult|ss=large+mammals|j...> (excite 34)

II) 35) Dr. Linzey Information

Faculty Information Page Professor of Biology Indiana Univ. of PA Direct Link to Dr. Linzey's Home Page Semester Schedule Office Hours Teaching Schedule ...

<http://search.excite.com/relocate/sr=webresult|ss=large+mammals|j...> (excite 35)

II) 36) Pleistocene Extinctions

by Kim Coover, ES 767, Spring '98 During the last glacial period, approximately 100,000 to 10,000 years ago, a wave of mass extinction occurred globally. ...

<http://search.excite.com/relocate/sr=webresult|ss=large+mammals|j...> (excite 36)

Search Engine 6: yahoo6

Query6: large+mammals

II) 19) Science > Biology > Zoology > Animals, Insects, and Pets > Mammals > Dogs > Breeds > Kangal Dog

...
http://dir.yahoo.com/Science/Biology/Zoology/Animals__Insects__an... (yahoo 19)

II) 20) Kangal Dog Page

one of several ...
http://www.rovers.net/~jnnelson/KANGAL_SITE/Page1.html (yahoo 20)

II) 21) Science > Biology > Zoology > Animals, Insects, and Pets > Mammals > Cats > Wild Cats > Cougars > Eastern Cougar

...
http://dir.yahoo.com/Science/Biology/Zoology/Animals__Insects__an... (yahoo 21)

II) 22) Eastern Cougar Foundation

non-profit corporation that was established as an advocacy organization to promote the recognition and the protection of the ...

<http://www.geocities.com/RainForest/Vines/1318/ecf.html> (yahoo 22)

II) 23) Science > Biology > Zoology > Animals, Insects, and Pets > Mammals > Dogs > Breeds > Newfoundland

...
http://dir.yahoo.com/Science/Biology/Zoology/Animals__Insects__an... (yahoo 23)

II) 24) Newfoundland Puppy Shopping List

comprehensive list of supplies for the new or prospective Newfoundland Dog owner. Also useful for owners of other ...

<http://www.pubrats.com/~nlc/newfoundlanddog> (yahoo 24)

II) 25) Science > Biology > Zoology > Animals, Insects, and Pets > Mammals > Dogs > Breeds > Yorkshire Terrier > Individual Dogs

...
http://dir.yahoo.com/Science/Biology/Zoology/Animals__Insects__an... (yahoo 25)

II) 26) Tas

the Yorkshire Terrorist. ...
<http://members.aol.com/TasYorkie/index.htm> (yahoo 26)

II) 27) Simply Servals

general information on Servals and other ...
<http://www.simplyservals.com> (yahoo 27)

II) 28) T&D's Cats Of The World

refuge for ...
<http://www.tdscats.com/> (yahoo 28)

II) 29) Regional > U.S. States > New Hampshire > Cities > Windham > Business and Shopping > Shopping and Services

...
http://dir.yahoo.com/Regional/U_S_States/New_Hampshire/Cities/Wi... (yahoo 29)

II) 30) Wildlife Technologies

manufacturers of a technologically advanced wildlife caller, with a ...
<http://www.wildlifetech.com> (yahoo 30)

II) 31) Regional > U.S. States > Maine > Recreation and Sports > Outdoors > Parks and Public Lands

...
http://dir.yahoo.com/Regional/U_S_States/Maine/Recreation_and_Sp... (yahoo 31)

II) 32) Sunkhaze Meadows National Wildlife Refuge

undeveloped 9,000 acre wildlife refuge, for waterfowl, ...
<http://www.mint.net/milford.mctel/sunkhaze.html> (yahoo 32)

II) 33) Science > Biology > Zoology > Animals, Insects, and Pets > Mammals > Dogs > Organizations > Kennel Clubs

...
http://dir.yahoo.com/Science/Biology/Zoology/Animals_Insects_an... (yahoo 33)

II) 34) United Kennel Club

second-oldest and second-...
<http://www.ukccogs.com> (yahoo 34)

II) 35) Science > Biology > Zoology > Animals, Insects, and Pets > Mammals > Dogs > Breeds > Italian Pointer (Spinone Italiano) > Spinone Club of America

...
http://dir.yahoo.com/Science/Biology/Zoology/Animals_Insects_an... (yahoo 35)

II) 36) Spinone Club of America

...
<http://www.spinone.com/index.htm> (yahoo 36)

Search Engine 7: looksmart7

Query7: large+mammals

II) 19) The Hall of Mammals

UCMP Hall of Mammals. Those hairy, milk-producing, warm-blooded animals that you have seen all of your life are mammals. The quagga, itself a mammal,.....
<http://www.ucmp.berkeley.edu/mammal/mammal.html> (looksmart 19)

II) 20) MAMMALS of OREGON

MAMMALS of OREGON. This is a simple placeholder page that links to the various projects for CAB98. Complete taxonomic index of the mammal species of.....
<http://www.lm.pdx.edu/~rueterj/CAB98/mammals.html> (looksmart 20)

II) 21) Electronic Zoo / NetVet Veterinary Resources - Marine Mammals

NetVet Veterinary Resources Marine Mammal Sites.....
<http://netvet.wustl.edu/marine.htm> (looksmart 21)

II) 22) The Mammals of Texas - Online Edition

an online guide to the 181 species of Texas mammals, based on Davis' and Schmidly's classic printed handbook.....
<http://www.nsr.ttu.edu/tmot/index.html> (looksmart 22)

II) 23) Terrestrial Mammals of the Arctic

Terrestrial Mammals of the Arctic. The Arctic and Its Wildlife BRYAN SAGE Facts on File excerpts from pages 118, 121-22, 173-74. The total.....
<http://lynx.uio.no/jon/lynx/arctmam.html> (looksmart 23)

II) 24) Mammals of Illinois

Mammals of Illinois. Phylum Chordata. Class Mammalia. Order Didelphimorphia: Opossums. Family Didelphidae: Opossums. *Didelphis virginiana* Kerr, 1792.....
<http://www.inhs.uiuc.edu/cbd/species/mammalsplst.html> (looksmart 24)

II) 25) Vulnerable Mammals Lists - Endangered Species Program

an error occurred while processing this directive] ANZECC Vertebrate Lists. Vulnerable Mammals. Index. Species. Common Name. *Pseudocheirus*.....
[http://www.biodiversity.environment.gov.au/plants/threaten/lists/...](http://www.biodiversity.environment.gov.au/plants/threaten/lists/) (looksmart 25)

II) 26) Presumed Extinct Mammals Lists - Endangered Species Program

an error occurred while processing this directive] ANZECC Vertebrate Lists. Presumed Extinct Mammals. Index. Species. Common Name. *Macrotis leucura*.....
[http://www.biodiversity.environment.gov.au/plants/threaten/lists/...](http://www.biodiversity.environment.gov.au/plants/threaten/lists/) (looksmart 26)

II) 27) Mammals Home Page

Mammals. By Robert Butinar. Peter Lalor Secondary College. Mammals are warm blooded animals that belong to the class Mammalia. They nourish their.....
<http://edx1.educ.monash.edu.au/~juanda/vcm/mammals.htm> (looksmart 27)

II) 28) WRCF - Birds and Mammals

Birds and Mammals. American Bittern. Loggerhead Shrike. Bald Eagle. Osprey. Black Tern. Peregrine Falcon. Delmarva Fox Squirrel. Sedge Wren. Eastern.....
<http://www.dcnr.state.pa.us/wrcf/bandm.htm> (looksmart 28)

II) 29) Mammals of Santa Barbara Backcountry

Mammals of Santa Barbara Backcountry. Return to Plants and Animals of Santa Barbara Backcountry
Blacktailed Jackrabbit Black Bear Brown Bear Bobcat.....
<http://www.sbceo.k12.ca.us/~mcssb/sbpanda/mammals.html> (looksmart 29)

II) 30) Mammals

Family. Scenery. Waterfalls. Birds. Reptiles. Amphibians. Insects. Wildflowers. Main Menu.
Montgomery's Home Page.....
<http://members.aol.com/MiReMo/Mammals.html> (looksmart 30)

II) 31) Orders of Mammals

Orders of Mammals. Mammalian Orders and Ohio Species. List created by Dr. Timothy L. Lewis,
Wittenberg University. Send Me Comments!!! All mammalian.....
<http://blackbox1.wittenberg.edu/academics/biol/courses/mammals/or...> (looksmart 31)

II) 32) The Meerkat Mpango

LOTS of info and pictures on, non other than, ****meerkats**** (we've also got lots of other mammals, as well!).....
<http://www.meerkat.org/> (looksmart 32)

II) 33) A Guide to Mammals of California

A Guide to Mammals of California. by. Daniel F. Williams, Ph.D. California State University, Stanislaus.
These web pages on California Mammals.....
<http://arnica.csustan.edu/esrpp/camammal.htm> (looksmart 33)

II) 34) Alphabetic Listing of Species Entries

The Mammals of Texas - Online Edition. Alphabetic Listing of Species Entries. Common Name:
Scientific Name: A. American Badger American Beaver.....
<http://www.nsr.ttu.edu/tmo/alphabet.htm> (looksmart 34)

II) 35) African Marine Mammals

African Marine Mammals.....
<http://elfi.com/csiafrica.html> (looksmart 35)

II) 36) Mammals of Australia

Webster's Mammals of Australia - multimedia CD-ROM - contents.....
http://www.websterpublishing.com/catalog/mammals_of_australia.sht... (looksmart 36)

Search Engine 8: hotbot8

Query8: large+mammals

II) 19) Large Mammals

Subject Large Mammals -- Page 13 of 17 -- (click on image for more information) "Black Timber-
Wolves" Rosemary Millette "Broken Silence-Elk" Rosemary Millette "Broken Silence-...
http://www.wildwingsdealers.com/Subjects/Large_Mammals_12.html (hotbot 19)

II) 20) Large Mammals Stock Photo

Large Mammal Stock photography content page...
<http://www.stockpix.com/stock/large/> (hotbot 20)

II) 21) Large Mammals

Large Mammals Large mammals do exist in the region, although their appearance is much less
common. The two largest land mammals inhabiting the region are the white-tailed deer and the Florida
panther. ...
<http://www.env.duke.edu/wetland/large.htm> (hotbot 21)

II) 22) Mudflows, Animal Colonizers, Large Mammals

Animal Colonizers, Large Mammals Mudflows created wide open areas where plant life is slowly
returning. As a result, there is little food or protection from severe weather for large mammals such as
elk...
http://volcano.und.nodak.edu/vwdocs/msh/p_a/p_aa/p_aamaclm.html (hotbot 22)

II) 23) Amazon.com: buying info: Mammals in the Seas : General Papers and Large Cetaceans

Books All Products * Explore this book buying info customer reviews See more by this author all books
by Food and Agriculture Organization of the U. N. Share your thoughts write a review e-mail a frien...
<http://amazon.com/exec/obidos/ISBN=9251005133/naturesownbooksta> (hotbot 23)

II) 24) LARGE MAMMAL PROGRAM

LARGE MAMMALS PROGRAM Program Overview The Large Mammals Program is responsible for the
effective development, implementation and evaluation of management programs to maintain populations
of white-tail...
<http://www.gov.ns.ca/nat/WILDLIFE/igmams/igm.htm> (hotbot 24)

II) 25) Whales are large

Whales are large Grade: Teacher School: Other Corvallis school Category:
Life_Science.Oceanography Expert: The Shadow >Why do we see whales that are very large, but none
that are very small? Whales ...
http://www.seps.org/oracle/oracle.archive/Expert/shadow/Life_Scie... (hotbot 25)

II) 26) Amazon.com: buying info: Large Mammals Activity Book

Search: Books All Products Browse: All Subjects Art & Architecture Audiobooks Awards Bestsellers
Bargain Books Biographies Business Children's Books Christian Books Computers & Internet - Certi...
<http://www.amazon.com/exec/obidos/ASIN/056501014X/hppubl00> (hotbot 26)

II) 27) ZOOM WHALES - Enchanted Learning Software

Explore whales, learn about their anatomy and behavior, study fossils and evolution, print out classroom
activities, read a whale glossary, find whale links, and more...
<http://www.zoomdinosaur.com/subjects/whales> (hotbot 27)

II) 28) LAND MAMMALS

Navigating the Bible Natural Sciences BISON TE'O BISON BISON Deuteronomy 14:5 The translators of the Living Torah espoused the term bison for the Hebrew te'o. Other scholars, however, suggest that the ...
http://bible.ort.org/Bible/htm/atlas/naturals/ani_biso.htm (hotbot 28)

II) 29) Dolphin Research : Gift Shop : the study of dolphins, marine mammals, cetaceans

a non-invasive photo id study of bottlenose dolphins, project pod seeks to educate the public about the species tursiops truncatus through pictures, videos, sound clips and links to other dolphin relat...
<http://www.swflorida.com/dolphin/giftshop.htm> (hotbot 29)

II) 30) PA MAMMALS

Mammals of Pennsylvania#151Eastern Chipmunk For a larger image, click on the picture Back to Main Menu| Back to Section of Mammals Main Page Common Name: Eastern chipmunk Scientific Name: Tamias s...
<http://warhol.org/cmnh/mammals/collections/PAmamm/PAmamD/chipmunk...> (hotbot 30)

II) 31) Northern Natural History Large Game Taxidermy Gallery

| Entrance | Birds | Mammals | Large Game | Home | | Entrance | Birds | Mammals | Large Game | Home | ...
<http://www.btinternet.com/~taxidermy/galleryyh.html> (hotbot 31)

II) 32) What is a Mammoth?

Mammoths were large mammals with trunks that closely resembled elephants. They became extinct about 10,000 years ago...
http://www.archaeologyonline.org/mammoth/cir_elem_ccm/cir_ccm_wha... (hotbot 32)

II) 33) ANIMAL GROUPS

ANIMAL GROUPS MAMMALS ...
<http://www.expage.com/page/mrsg5> (hotbot 33)

II) 34) Fossil Mammals

Fossil Mammals for Sale...
<http://www.xfossil.com/page0008.htm> (hotbot 34)

II) 35) NMNH Virtual Tour - Fossil Mammals

Miocene Mammals 23-25 million years old A fossil menagerie from Nebraska includes early horses, camels, rhinos, and Chalichotheres, a now-extinct clawed animal. As grasslands spread, many animals adapt...
<http://www.naturalpartners.org/VirtualTour/Tour/First/FossilMamma...> (hotbot 35)

II) 36) Mammals.- Persian Lion

Persian Lion At one time the Persian lion roamed across much of the Middle East and southern Asia. Then, as human populations expanded, the lion population lost its territory and, as a result, dwindled...
<http://www.pakcenter.com/reading/education/zoo/mammals/PersianLio...> (hotbot 36)

Look4itHere

Div. of Internet Corporation

- [News](#)
- [Weather](#)
- [Cool Sites](#)
- [Shopping](#)
- [Contests](#)
- [Horoscopes](#)
- [Classified](#)

[Visit Look4itHere2](#)

Phone: 1-631-757-1600 · E-Mail: look4itthere@look4itthere.com · Internet Corporation

Previous Group: I				Current Group: II				Next Group: III
webcrawler1	altavista2	lycos3	infoseek4	excite5	yahoo6	looksmart7	hotbot8	dejanews9
large mammals	large mammals	large mammals	large mammals	large mammals	large mammals	large mammals	large mammals	large mammals
Go to page: 1 2 3 4 5 6 7 8 9 10 Go to: [Previous Page] [Next Page]								
11								
Search Display (Interleaved or separately by search engine): [Interleave]								
Description or List (Site descriptions or lists): [List]								



Look4itHere

Discovery
Disney, Warner, ABC, Universal, CBS, NBC

Hot Wired
E!Online, Riddler

TV Guide
Reel.com, MusicBlvd, RealAudio, AudioNet

BuyerSellers
Ebay, DrugStore, ShopNow, Vitamin

CIA Kids
eToys, KBkids, Pets, ToysRus, PetSmart

Family
BlueMount, Women, Village, Epicurious

Weather
Intellicast, MapQuest

CitySearch
555-1212, Travelocity, Fodor's, LeisurePlan

ESPN
Sportsline, NFL, NBA, SmallWorld, NHL

CNN
NYTimes, WSJournal, USAtoday, ABCnews

StockMaster
CNNfn, Bloomberg, DowJones, Quote

CNet
ZDNet, CMPnet, IDG, Outpost, Jumbo

Monster Board
JobBank, BestJobs, Career, Incpad, Inti

Search'em All: Search your favorite search engines, all at the same time*

Search 1: <input type="text" value="Cat"/>	<input type="text" value="Amazon.com"/>
Search 2: <input type="text" value="Cat"/>	<input type="text" value="Borders.com"/>
Search 3: <input type="text" value="Cat"/>	<input type="text" value="BarnesandNoble.com"/>
Search 4: <input type="text" value="Mouse"/>	<input type="text" value="Amazon.com"/>
Search 5: <input type="text" value="Dog"/>	<input type="text" value="Amazon.com"/>
Search 6: <input type="text" value="Dog"/>	<input type="text" value="BarnesandNoble.com"/>
Search 7: <input type="text" value="Mouse"/>	<input type="text" value="BarnesandNoble.com"/>
Search 8: <input type="text" value="Dog"/>	<input type="text" value="Borders.com"/>
Search 9: <input type="text" value="Cat"/>	<input type="text" value="Google"/>

Search Engine Results: URL's per Search Engine:

URL Details: Timeout (seconds) per Search Engine:

Page: Searches per Group: Group: * Only 1 entry required

Search'em All: multiple simultaneous same* or different searches

- **Autos**
Buy, Cars, Racing
- **Business**
Investments, Funds, Companies, Industry
- **Careers**
Jobs, Universities, Education
- **Entertainment**
Movies, Music, TV, Games, Chat
- **Fashion**
Designers, Style, Models
- **Health**
Drugs, Diseases, News
- **Homes**
Food, Wine, Gardening
- **Issues**
Government, Politics, Taxes, Editorials
- **People**
Relationships, Dating, Psychology
- **Society**
Philosophy, Economics, Religion, Sociology
- **Sports**
Baseball, Basketball, Football, Hockey,
- **Technology**
Computers, Environment, Engineering, Internet
- **Travel**
Maps, Vacations, Fares

Flowers for your Valentine
std.com
NOW easy ordering at
N Netscape Netcenter
Click Here...

netMarket Auction VCR Spectacular
Bids start at **1**
Click Now!

February 6, 1998
NEWS ABC NEWS Headlines
U.S. Presence Growing in Iraq

Look4itHere
Div. of Internet Corporation

[News](#) [Weather](#) [Cool Sites](#) [Shopping](#)
[Contests](#) [Horoscopes](#) [Classified](#)

Phone: 1-631-757-1600 · E-Mail: look4itHere@look4itHere.com · Internet Corporation.

FIG. 53

FIG. 54

Look4ItHere

Discovery
Disney, Warner, ABC, Universal, CBS, NBC

Hot Wired
E!Online, Riddler

TV Guide
Reel.com, MusicBlvd, RealAudio, AudioNet

BuyerSellers
eBay, DrugStore, ShopNow, Vitamin

CIA Kids
eToys, KBkids, Pets, ToysRus, PetSmart

Family
BlueMount, Women, Village, Epicurious

Weather
Intellicast, MapQuest

CitySearch
555-1212, Travelocity, Fodor's, LeisurePlan

ESPN
SportsLine, NFL, NBA, SmallWorld, NHL

CNN
NYtimes, WSJournal, USAtoday, ABCnews

StockMaster
CNNfn, Bloomberg, DowJones, Quote

CNet
ZDNet, CNetnet, iDG, Outpost, Jumboc

Monster Board
JobBank, BestJobs, Career, Incpad, Intl

Search'em All! Search your favorite search engines, all at the same time!

Search 1:	<input type="text"/>	WebCrawler
Search 2:	<input type="text"/>	Altavista
Search 3:	<input type="text"/>	Lycos
Search 4:	<input type="text"/>	Google
Search 5:	<input type="text"/>	Excite
Search 6:	<input type="text"/>	Yahoo
Search 7:	<input type="text"/>	LookSmart
Search 8:	<input type="text"/>	HotBot
Search 9:	<input type="text"/>	Dejanews

Search Engine Results: URL's per Search Engine:

URL Details: Timeout (seconds) per Search Engine:

Page: Searches per Group: Group: Only 1 entry required

Flowers for your Valentine [tta.com](#)

Now easy ordering at **N**etscape Netcenter [Click Here...](#)

netMarket Auction VCR Spectacular

Bids start at **\$1**

[Click Now!](#)

February 6, 1999
NEWS ABC NEWS Headlines

U.S. Presence Growing in Iraq

Search Engine Report

Query: **Cat**

	Order Quantity Below
I) 1) Cat's Letters to Santa In Stock: 24 hours (Same Day). Bill Adler (Editor), Paul Bacon (Illustrator) / Hardcover / Galahad Books / September 1997 B&N Price: \$2.99 ~ You Save 50%... http://shop.barnesandnoble.com/booksearch/isbnInquiry.asp?userid=... (barnesandnoble)	<input type="checkbox"/>
I) 2) 2001 Hello Kitty Wall Calendar In Stock: 24 hours. Cal 2001 (Illustrator) / Wall Calendar / Abrams, Harry N Inc / June 2000 B&N Price: \$4.97 ~ You Save 50%... http://shop.barnesandnoble.com/booksearch/isbnInquiry.asp?userid=... (barnesandnoble)	<input type="checkbox"/>
I) 3) 2001 Original 365 Cats Page-A-Day Calendar In Stock: 24 hours. Cal 2001 / Box Calendar / Workman Publishing Company, Inc. / June 2000 B&N Price: \$5.47 ~ You Save 50%... http://shop.barnesandnoble.com/booksearch/isbnInquiry.asp?userid=... (barnesandnoble)	<input type="checkbox"/>
I) 4) 2001 Classic Cats Wall Calendar In Stock: 24 hours. Cal 2001 / Wall Calendar / June 2000 B&N Price: \$5.97 ~ You Save 50%... http://shop.barnesandnoble.com/booksearch/isbnInquiry.asp?userid=... (barnesandnoble)	<input type="checkbox"/>
I) 5) Abyssinian Cats: Everything about Acquisition, Care, Nutrition, Behavior, Health Care, & Breeding In stock - ships in 24 hours Hauppauge, J. Anne ~ Trade Paperback ~ 1995 Borders Price: \$6.26 ~ You Save: \$0.69 (10%)... http://search.borders.com/cgi-bin/db2www/search/search.d2w/Detail... (borders)	<input type="checkbox"/>
I) 6) Pawing Through the Past (Age of Unreason) Usually ships in 24 hours by Rita Mae Brown, Sneaky Pie Brown (Mass Market Paperback - January 2001) Amazon Price: \$6.29... http://www.amazon.com/exec/obidos/ASIN/0553580256/qid=981919741/s... (amazon)	<input type="checkbox"/>
I) 7) The Cat Who Robbed a Bank In Stock: 24 hours (Same Day). Lillian Jackson Braun / Paperback / Berkley Publishing Group / January 2001 B&N Price: \$6.29 ~ You Save 10%... http://shop.barnesandnoble.com/booksearch/isbnInquiry.asp?userid=... (barnesandnoble)	<input type="checkbox"/>
I) 8) Animal Clinic for Cats In stock - ships in 24 hours Humphries, Jim ~ Hardcover ~ 1998 Borders Price: \$6.39 ~ You Save: \$1.60 (20%)... http://search.borders.com/cgi-bin/db2www/search/search.d2w/Detail... (borders)	<input type="checkbox"/>
I) 9) The Cat in the Hat (Classic Gift Seuss Series) In Stock: 24 hours (Same Day). Dr. Seuss / Hardcover / Random House, Incorporated / May 1976 B&N Price: \$6.39 ~ You Save 20%... http://shop.barnesandnoble.com/booksearch/isbnInquiry.asp?userid=... (barnesandnoble)	<input type="checkbox"/>
I) 10) Adopting Cats & Kittens: A Care & Training Guide Ships within 2-3 days Jankowski, Connie ~ Trade Paperback ~ 1993 Borders Price: \$7.20 ~ You Save: \$0.80 (10%)... http://search.borders.com/cgi-bin/db2www/search/search.d2w/Detail... (borders)	<input type="checkbox"/>
I) 11) Bedtime Stories for Cats In stock - ships in 24 hours Jasheway, Leigh A. ~ Hardcover ~ 1997 Borders Price: \$7.96 ~ You Save: \$1.99 (20%)... http://search.borders.com/cgi-bin/db2www/search/search.d2w/Detail... (borders)	<input type="checkbox"/>
I) 12) How to Live with a Neurotic Cat In Stock: 24 hours (Same Day).	<input type="checkbox"/>

Stephen Baker / Hardcover / Random House Value Publishing, incorporated /
September 1999
B&N Price: \$7.99...
<http://shop.barnesandnoble.com/booksearch/sbnInquiry.asp?userid=...> (barnesandnoble)

I) 13) 250 Things You Can Do to Make Your Cat Adore You

In stock - ships in 24 hours
NewKirk, Ingrid ~ Trade Paperback ~ 1998
Borders Price: \$9.90 ~ You Save: \$1.10 (10%)...
<http://search.borders.com/cgi-bin/db2www/search/search.d2w/Detai...> (borders)

I) 14) Eating the Cheshire Cat

Usually ships in 24 hours
by Helen Ellis(Paperback - February 2001)
Amazon Price: \$10.40...
<http://www.amazon.com/exec/obidos/ASIN/088486441X/qid=981919741/s...> (amazon)

I) 15) Master the Gre Cat 2001 (Master the Gre, 2001)

Usually ships in 2-3 days
by Thomas H. Martinson(Paperback - November 2000)
Amazon Price: \$11.16...
<http://www.amazon.com/exec/obidos/ASIN/0764561197/qid=981919741/s...> (amazon)

I) 16) Aloha, Dolores

In stock - ships in 24 hours
Samuels, Barbara ~ Hardcover ~ 2000
Borders Price: \$12.76 ~ You Save: \$3.19 (20%)...
<http://search.borders.com/cgi-bin/db2www/search/search.d2w/Detai...> (borders)

I) 17) Cat Heaven

Usually ships in 24 hours
by Cynthia Rylant(illustrator)(School & Library Binding - September 1997)
Amazon Price: \$12.76...
<http://www.amazon.com/exec/obidos/ASIN/0590100548/qid=981919741/s...> (amazon)

I) 18) Alfie & the Birthday Surprise

In stock - ships in 24 hours
Hughes, Shirley ~ Hardcover ~ 1998
Borders Price: \$12.80 ~ You Save: \$3.20 (20%)...
<http://search.borders.com/cgi-bin/db2www/search/search.d2w/Detai...> (borders)

I) 19) All about Himalayan Cats

In stock - ships in 24 hours
Bearley, Joan M. ~ Hardcover ~ 1989
Borders Price: \$14.36 ~ You Save: \$3.59 (20%)...
<http://search.borders.com/cgi-bin/db2www/search/search.d2w/Detai...> (borders)

I) 20) The Cat Who Smelled a Rat [ABRIDGED]

Usually ships in 24 hours
by Lillian Jackson Braun(Audio Cassette - January 2001)
Amazon Price: \$16.15...
<http://www.amazon.com/exec/obidos/ASIN/0399146814/qid=981919741/s...> (amazon)

I) 21) The Cat Who Covered the World : The Adventures of Henrietta and Her Foreign Correspondent

Usually ships in 24 hours
by Christopher S. Wren(Hardcover - November 2000)
Amazon Price: \$16.80...
<http://www.amazon.com/exec/obidos/ASIN/0684871009/qid=981919741/s...> (amazon)

I) 22) Arthur's World of Cats

In stock - ships in 24 hours
Head, Ann ~ Hardcover ~ 1997
Borders Price: \$18.36 ~ You Save: \$4.59 (20%)...
<http://search.borders.com/cgi-bin/db2www/search/search.d2w/Detai...> (borders)

I) 23) The Cat Who Smelled a Rat

In Stock: 24 hours (Same Day).
Lillian Jackson Braun / Hardcover / Penguin Putnam / January 2001
B&N Price: \$19.16 ~ You Save 20%...
<http://shop.barnesandnoble.com/booksearch/sbnInquiry.asp?userid=...> (barnesandnoble)

I) 24) The Cat Who Smelled a Rat

Usually ships in 24 hours
by Lillian Jackson Braun(Hardcover - January 2001)
Amazon Price: \$19.16...
<http://www.amazon.com/exec/obidos/ASIN/0399146652/qid=981919741/s...> (amazon)

I) 25) Cracking the GRE CAT with CD-ROM, 2001 Edition

In Stock: 24 hours (Same Day).
Karen Lurie / Paperback / Princeton Review Publishing Corporation / June 2000
B&N Price: \$24.80 ~ You Save 20%...
<http://shop.barnesandnoble.com/booksearch/sbnInquiry.asp?userid=...> (barnesandnoble)

I) 26) Cracking the Gmat 2001 (Cracking the Gmat Cat With Sample Tests on Cd-Rom)

Usually ships in 24 hours
by Martz, Geoff Martz(Paperback - June 2000)
Amazon Price: \$27.96...
<http://www.amazon.com/exec/obidos/ASIN/0375756248/qid=981919741/s...> (amazon)

I) 27) Cracking the GMAT CAT with CD-ROM, 2001 Edition

In-Stock: Ships 2-3 days.
Geoff Martz / Paperback / Princeton Review Publishing Corporation / June 2000
B&N Price: \$27.96 ~ You Save 20%...
<http://shop.barnesandnoble.com/booksearch/sbnInquiry.asp?userid=...> (barnesandnoble)

I) 28) Gmat 2000-2001 (Gmat Cat (Kaplan)(Book & Cd-Rom))

Usually ships in 24 hours
(Paperback - March 2000)
Amazon Price: \$29.60...
<http://www.amazon.com/exec/obidos/ASIN/0684870088/qid=981919741/s...> (amazon)

I) 29) Accreditation of Teacher Education: The Story of CATE 1984-1989

In stock - ships in 24 hours
MacIntyre, Gordon ~ Trade Paperback ~ 1991
Borders Price: \$34.95 ...
<http://search.borders.com/cgi-bin/db2www/search/search.d2w/Detai...> (borders)

I) 30) Textbook of Veterinary Internal Medicine: Diseases of the Dog and Cat (2-Volume Set)

Usually ships in 24 hours
by Stephen J. Ettinger(Editor), Edward C. Feldman(Editor)(Hardcover)
Amazon Price: \$195.00...
<http://www.amazon.com/exec/obidos/ASIN/0721672568/qid=981919741/s...> (amazon)

**I) 31) Alley Cat Allies**

Alley Cat Allies Has a Better Idea. Modeled after successful programs in the United Kingdom and parts of Africa and Europe, Alley Cat Allies (ACA) advocates a ...
<http://www.alleycat.org/> (google)

I) 32) Arctic Cat > What Drives You to the Great Outdoors?

Arctic Cat. Snowmobile ATV Watercraft Generators Catalogs. What's new on the site? Click ...
<http://www.arctic-cat.com/> (google)

I) 33) Beware of Cat! HUGE Cat Graphics Collection & Virtual Cat ...

Cat Postcards! Send an electronic Cat Postcard Now! Hundreds of cute cat cards to choose from! Holidays, Kittens, Cartoons, Love & More! Add Music, Backgrounds ...
<http://www.geocities.com/Hearland/Meadows/6485/> (google)

I) 34) Cat-Scan.Com - The Cover Page

Welcome to CliftyB's Cat-Scan! Cat-Scan is home to people who love art as much as their cats. So much so, they combine the two! Every weekday we'll bring you ...
<http://www.cat-scan.com/> (google)

I) 35) Cat Fanciers Web Site

Welcome to the Cat Fanciers Web Site! We offer General Information about Cats and Cat Care, Cat Breed Descriptions from Abyssinian to Turkish Van, ...
<http://www.fanciers.com/> (google)

I) 36) Cat Fancy

or killed playing with toy mice distributed in packages of Fresh Step cat litter, Clorox Co., Oakland, Calif., warned pet owners the toys could strangle or cut ...
<http://www.animalnetwork.com/cats/default.asp> (google)

I) 37) Cat Tales Zoological Park

LATEST UPDATE: October 20, 2000. Cat Tales Zoological Park. Do you have what it takes to become a zookeeper? Cat Tales Zoological Training Center. ...
<http://www.cattales.org/> (google)

I) 38) Feral Cat Coalition

Feral Cat Coalition. San Diego, California. Please follow these links for more information on the subject: Feral Cat Coalition Documents. ...
<http://www.feralcat.com/> (google)

I) 39) The Cat Fanciers' Association (CFA)

Welcome to the Cat Fanciers' Association, the world's largest registry of pedigreed cats! ...
<http://www.cfainc.org/> (google)

I) 40) TICA Website

WELCOME TO THE WEB SITE OF THE INTERNATIONAL CAT ASSOCIATION To Navigate the Site Frames No Frames Please See this page as a Shockwave movie. ...
<http://www.tica.org/> (google)

Query: Mouse**I) 1) Santa Mouse Coloring and Pencil Puzzle Book**

In Stock: 24 hours (Same Day).
Michael Brown / Paperback / Barnes & Noble Books / July 1999
B&N Price: \$1.49 ~ You Save 50%...
<http://shop.barnesandnoble.com/booksearch/sbInquiry.asp?userid=...> (barnesandnoble)

**I) 2) Santa Mouse**

In Stock: 24 hours (Same Day).
Michael Brown,Elfrieda DeWitt (Illustrator) / Hardcover / Barnes & Noble Books / August 1996
B&N Price: \$2.49 ~ You Save 50%...
<http://shop.barnesandnoble.com/booksearch/sbInquiry.asp?userid=...> (barnesandnoble)

**I) 3) Santa Mouse Where Are You**

In Stock: 24 hours (Same Day).
Michael Brown,Elfrieda DeWitt (Illustrator) / Hardcover / Barnes & Noble Books / August 1997
B&N Price: \$2.49 ~ You Save 50%...
<http://shop.barnesandnoble.com/booksearch/sbInquiry.asp?userid=...> (barnesandnoble)

**I) 4) Disney's Toy Story: Movie Storybook**

In Stock: 24 hours (Same Day).
Mouse Works Staff / Hardcover / Disney Enterprises, Incorporated / May 2000
B&N Price: \$3.98 ~ You Save 42%...
<http://shop.barnesandnoble.com/booksearch/sbInquiry.asp?userid=...> (barnesandnoble)

**I) 5) The Mouse and the Motorcycle**

In Stock: 24 hours (Same Day).
Beverly Cleary,Louis Darling (Illustrator) / Paperback / Morrow,William & Co / August 1990
B&N Price: \$4.45 ~ You Save 10%...
<http://shop.barnesandnoble.com/booksearch/sbInquiry.asp?userid=...> (barnesandnoble)

**I) 6) Mouse Count**

Usually ships in 24 hours
by Ellen Stoll Walsh(Paperback - March 1995)
Amazon Price: \$4.95...
<http://www.amazon.com/exec/obidos/ASIN/0152002235/qid=981919741/s...> (amazon)

**I) 7) Ben and Me : A New and Astonishing Life of Benjamin Franklin As Written by His Good Mouse Amos**

Usually ships in 24 hours
by Robert Lawson(Illustrator)(Paperback - April 1988)
Amazon Price: \$5.35...
<http://www.amazon.com/exec/obidos/ASIN/0316517305/qid=981919741/s...> (amazon)

**I) 8) Cat & Mouse**

Usually ships in 24 hours
by James Patterson(Mass Market Paperback - October 2000)
Amazon Price: \$7.19...
<http://www.amazon.com/exec/obidos/ASIN/0446606189/qid=981919741/s...> (amazon)



I) 9) Cat & Mouse

In Stock: 24 hours (Same Day).
James Patterson / Mass Market Paperback / Warner Books, Incorporated / October 1998
B&N Price: \$7.19 ~ You Save 10%...
<http://shop.barnesandnoble.com/booksearch/isbnInquiry.asp?userid=...> (barnesandnoble)

I) 10) If You Give a Mouse a Cookie Mini Book and Ornament

In Stock: 24 hours.
Laura Joffe Numeroff, Felicia Bond (Illustrator) / Hardcover / HarperCollins Children's Books / September 2000
B&N Price: \$7.96 ~ You Save 20%...
<http://shop.barnesandnoble.com/booksearch/isbnInquiry.asp?userid=...> (barnesandnoble)

I) 11) Mouse Count

Usually ships in 1-2 weeks
by Ellen Stoll Walsh, Diane D'Andrade(Editor)(School & Library Binding - March 1991)
Amazon Price: \$10.40...
<http://www.amazon.com/exec/obidos/ASIN/0152560238/qid=981919741/s...> (amazon)

I) 12) If You Give a Mouse a Cookie

In Stock: 24 hours (Same Day).
Laura Joffe Numeroff, Felicia Bond (Illustrator) / Hardcover / HarperCollins Children's Books / January 1985
B&N Price: \$11.96 ~ You Save 20%...
<http://shop.barnesandnoble.com/booksearch/isbnInquiry.asp?userid=...> (barnesandnoble)

I) 13) The Mouse of Amherst

Usually ships in 24 hours
by Elizabeth Spires, Claire A. Nivola(Illustrator)(Hardcover - March 1999)
Amazon Price: \$12.00...
<http://www.amazon.com/exec/obidos/ASIN/0374350833/qid=981919741/s...> (amazon)

I) 14) If You Give a Mouse a Cookie

Usually ships in 24 hours
by Felicia Bond(Illustrator), Laura Joffe Numeroff(Hardcover - May 1985)
Amazon Price: \$12.76...
<http://www.amazon.com/exec/obidos/ASIN/0080245867/qid=981919741/s...> (amazon)

I) 15) If You Take a Mouse to the Movies

Usually ships in 24 hours
by Felicia Bond(Illustrator), Laura Joffe Numeroff(Hardcover - October 2000)
Amazon Price: \$12.76...
<http://www.amazon.com/exec/obidos/ASIN/0050278676/qid=981919741/s...> (amazon)

I) 16) If You Take a Mouse to the Movies

In Stock: 24 hours.
Laura Joffe Numeroff, Felicia Bond (Illustrator) / Hardcover / HarperCollins Children's Books / September 2000
B&N Price: \$12.76 ~ You Save 20%...
<http://shop.barnesandnoble.com/booksearch/isbnInquiry.asp?userid=...> (barnesandnoble)

I) 17) Craft Lessons: Teaching Writing K through 8

In Stock: 24 hours.
Ralph J. Fletcher, Joann Portalupi / Paperback / Stenhouse Publishers / September 1998
B&N Price: \$17.50...
<http://shop.barnesandnoble.com/booksearch/isbnInquiry.asp?userid=...> (barnesandnoble)

I) 18) What's Wrong with My Mouse?: Behavioral Phenotyping of Transgenic and Knockout Mice

Usually ships in 24 hours
by Jacqueline N., Phd Crawley(Hardcover)
Amazon Price: \$79.95...
<http://www.amazon.com/exec/obidos/ASIN/0471316393/qid=981919741/s...> (amazon)

I) 19) The Anatomical Basis of Mouse Development

Usually ships in 24 hours
by Matthew H. Kaufman, Jonathan B. L. Bard(Hardcover - March 1999)
Amazon Price: \$99.95...
<http://www.amazon.com/exec/obidos/ASIN/0124020607/qid=981919741/s...> (amazon)

I) 20) The Atlas of the Mouse Development

Usually ships in 24 hours
by Matthew H. Kaufman(Hardcover - October 1997)
Amazon Price: \$225.00...
<http://www.amazon.com/exec/obidos/ASIN/0124020356/qid=981919741/s...> (amazon)

Query: Dog

I) 1) Clifford's First Valentine's Day

In-Stock: Ships 2-3 days.
Norman Bridwell / Paperback / Scholastic, Inc. / November 1996
B&N Price: \$2.69 ~ You Save 10%...
<http://shop.barnesandnoble.com/booksearch/isbnInquiry.asp?userid=...> (barnesandnoble)

I) 2) Baby Animals: Puppies

In stock - ships in 24 hours
Petty, Kate ~ Trade Paperback ~ 1992
Borders Price: \$3.56 ~ You Save: \$0.39 (10%)...
<http://search.borders.com/cgi-bin/db2www/search/search.d2w/Detail...> (borders)

I) 3) Tigers at Twilight: (Magic Tree House Series #19)

In Stock: 24 hours (Same Day).
Mary Pope Osborne, Sal Murdocca (Illustrator) / Paperback / Random House Books for Young Readers / August 1999
B&N Price: \$3.59 ~ You Save 10%...
<http://shop.barnesandnoble.com/booksearch/isbnInquiry.asp?userid=...> (barnesandnoble)

I) 4) Stone Fox (Harper Trophy Book)

Usually ships in 24 hours
by John Reynolds Gardiner, Marcia Sewall(Illustrator)(Paperback - February 1988)
Amazon Price: \$4.45...
<http://www.amazon.com/exec/obidos/ASIN/0054401324/qid=981919741/s...> (amazon)

I) 5) Clifford: The Big Red Dog

- In Stock: 24 hours (Same Day).
Norman Bridwell / Board Book / Scholastic, Inc. / July 1997
B&N Price: \$4.79 ~ You Save 20%...
<http://shop.barnesandnoble.com/booksearch/isbnInquiry.asp?userid=...> (barnesandnoble)
- I) 6) Where the Red Fern Grows**
In Stock: 24 hours (Same Day).
Wilson Rawls / Mass Market Paperback / Bantam Books, Incorporated / May 1981
B&N Price: \$5.39 ~ You Save 10%...
<http://shop.barnesandnoble.com/booksearch/isbnInquiry.asp?userid=...> (barnesandnoble)
- I) 7) Ginger Pye**
In Stock: 24 hours (Same Day).
Eleanor Estes / Paperback / Harcourt / September 2000
B&N Price: \$5.40 ~ You Save 10%...
<http://shop.barnesandnoble.com/booksearch/isbnInquiry.asp?userid=...> (barnesandnoble)
- I) 8) 2001 Original 365 Dogs Page-A-Day Calendar**
In Stock: 24 hours.
Cal 2001 / Box Calendar / Workman Publishing Company, Inc. / August 2000
B&N Price: \$5.47 ~ You Save 50%...
<http://shop.barnesandnoble.com/booksearch/isbnInquiry.asp?userid=...> (barnesandnoble)
- I) 9) 2001 William Wegman Puppies Wall Calendar**
In Stock: 24 hours.
Cal 2001 / Wall Calendar / Abrams, Harry N Inc / June 2000
B&N Price: \$5.47 ~ You Save 50%...
<http://shop.barnesandnoble.com/booksearch/isbnInquiry.asp?userid=...> (barnesandnoble)
- I) 10) How to Housebreak Your Dog in 7 Days**
Usually ships in 24 hours
by Shirlee Kalstone (Paperback - April 1991)
Amazon Price: \$6.29...
<http://www.amazon.com/exec/obidos/ASIN/0553346156/qid=981919741/s...> (amazon)
- I) 11) Animal Clinic for Dogs**
In stock - ships in 24 hours
Humphries, Jim ~ Hardcover ~ 1998
Borders Price: \$6.39 ~ You Save: \$1.60 (20%)...
<http://search.borders.com/cgi-bin/db2www/search/search.d2w/Detail...> (borders)
- I) 12) 2001 Man's Best Friend Wall Calendar**
In Stock: 24 hours.
Cal 2001, William Wegman (Photographer) / Wall Calendar / Abrams, Harry N Inc / June 2000
B&N Price: \$6.47 ~ You Save 50%...
<http://shop.barnesandnoble.com/booksearch/isbnInquiry.asp?userid=...> (barnesandnoble)
- I) 13) How to Live with a Neurotic Dog**
In Stock: 24 hours (Same Day).
Stephen Baker, Fred Hilliard (Illustrator) / Hardcover / Random House, Incorporated / February 1995
B&N Price: \$7.99...
<http://shop.barnesandnoble.com/booksearch/isbnInquiry.asp?userid=...> (barnesandnoble)
- I) 14) Adopting the Racing Greyhound**
In stock - ships in 24 hours
Branigan, Cynthia A. ~ Trade Paperback ~ 1998
Borders Price: \$11.66 ~ You Save: \$1.29 (10%)...
<http://search.borders.com/cgi-bin/db2www/search/search.d2w/Detail...> (borders)
- I) 15) Bark Busters: Solving Your Dog's Behavioral Problems**
In stock - ships in 24 hours
Wilson, Sylvia ~ Trade Paperback ~ 1997
Borders Price: \$11.66 ~ You Save: \$1.29 (10%)...
<http://search.borders.com/cgi-bin/db2www/search/search.d2w/Detail...> (borders)
- I) 16) Dog Heaven**
Usually ships in 24 hours
by Cynthia Rylant (Illustrator) (School & Library Binding - September 1995)
Amazon Price: \$12.76...
<http://www.amazon.com/exec/obidos/ASIN/0590417010/qid=981919741/s...> (amazon)
- I) 17) The Stray Dog**
Usually ships in 24 hours
by Marc Simon (Illustrator), Reiko Sassa (Hardcover - January 2001)
Amazon Price: \$12.76...
<http://www.amazon.com/exec/obidos/ASIN/0060289333/qid=981919741/s...> (amazon)
- I) 18) Anastasia, Absolutely**
In stock - ships in 24 hours
Lowry, Lois ~ Hardcover ~ 1995
Borders Price: \$12.80 ~ You Save: \$3.20 (20%)...
<http://search.borders.com/cgi-bin/db2www/search/search.d2w/Detail...> (borders)
- I) 19) Let the Big Dog Eat : A Dictionary of the Secret Language of Golf**
Usually ships in 24 hours
by Hubert Pedrol, et al (Hardcover - June 2000)
Amazon Price: \$14.40...
<http://www.amazon.com/exec/obidos/ASIN/0688175767/qid=981919741/s...> (amazon)
- I) 20) Dog: The Complete Guide**
In Stock: 24 hours (Same Day).
Sarah Whitehead / Hardcover / Barnes & Noble Books / August 1999
B&N Price: \$14.98...
<http://shop.barnesandnoble.com/booksearch/isbnInquiry.asp?userid=...> (barnesandnoble)
- I) 21) Baby's Memory Book: A Baby Record Book**
In stock - ships in 24 hours
Nister, Ernest ~ Hardcover ~ 1986
Borders Price: \$15.99 ~ You Save: \$4.00 (20%)...
<http://search.borders.com/cgi-bin/db2www/search/search.d2w/Detail...> (borders)
- I) 22) Dog Training for Dummies (For Dummies)**
Usually ships in 24 hours
by John Volhard, et al (Paperback - January 2001)
Amazon Price: \$17.59...
<http://www.amazon.com/exec/obidos/ASIN/0764552864/qid=981919741/s...> (amazon)

I) 23) How to Be Your Dog's Best Friend : A Training Manual for Dog Owners
 Usually ships in 24 hours
 by New Skete Monks, et al(Hardcover - October 1978)
 Amazon Price: \$19.16...
<http://www.amazon.com/exec/obidos/ASIN/0316604917/qid=981919741/s...> (amazon)

I) 24) Going for the Blue: Inside the World of Show Dogs and Dog Shows
 Usually ships in 24 hours
 by Roger A. Caras(Hardcover - February 2001)
 Amazon Price: \$20.76...
<http://www.amazon.com/exec/obidos/ASIN/0446526444/qid=981919741/s...> (amazon)

I) 25) Family Dog : 16 Weeks to a Well-Mannered Dog-A Simple and Time-Proven Method
 Usually ships in 24 hours
 by Richard A. Wolters, Red Smith(Introduction)(Hardcover - February 1995)
 Amazon Price: \$22.36...
<http://www.amazon.com/exec/obidos/ASIN/0525944729/qid=981919741/s...> (amazon)

I) 26) The Dog Owners Home Veterinary Handbook
 Usually ships in 2-3 days
 by James M. Giffin, et al(Hardcover - November 1999)
 Amazon Price: \$22.36...
<http://www.amazon.com/exec/obidos/ASIN/0876052014/qid=981919741/s...> (amazon)

I) 27) A-Z of Dog Diseases & Health Problems
 In stock - ships in 24 hours
 Lane, Dick ~ Trade Paperback ~ 1997
 Borders Price: \$22.49 ~ You Save: \$2.49 (10%)...
<http://search.borders.com/cgi-bin/db2www/search/search.d2w/Detai...> (borders)

I) 28) American Staffordshire Terrier: Gamester & Guardian
 In stock - ships in 24 hours
 Foster, Sarah ~ Trade Paperback ~ 1998
 Borders Price: \$22.46 ~ You Save: \$2.49 (10%)...
<http://search.borders.com/cgi-bin/db2www/search/search.d2w/Detai...> (borders)

I) 29) Agility Training: The Fun Sport for All Dogs
 In stock - ships in 24 hours
 Simmons-Moake, Jane ~ Trade Paperback ~ 1992
 Borders Price: \$23.36 ~ You Save: \$2.59 (10%)...
<http://search.borders.com/cgi-bin/db2www/search/search.d2w/Detai...> (borders)

I) 30) Advanced Gundog Training: Practical Fieldwork & Competition
 In stock - ships in 24 hours
 Deeley, Martin ~ Hardcover ~ 1994
 Borders Price: \$27.95 ~ You Save: \$6.99 (20%)...
<http://search.borders.com/cgi-bin/db2www/search/search.d2w/Detai...> (borders)

Look4ithere
 Div. of Internet Corporation
 • News • Weather • Cool Sites • Shopping
 • Contests • Horoscopes • Classified

Phone: 1-631-757-1600 • E-Mail: look4ithere@look4ithere.com • Internet Corporation.

Current Group: I

amazon1	borders2	barnesandnoble3	amazon4	amazon5	barnesandnoble6	barnesandnoble7	borders8	google9
Cat	Cat	Cat	Mouse	Dog	Dog	Mouse	Dog	Cat

Go to page: [1](#) [2](#) [3](#) [4](#) [5](#) [6](#) [7](#) [8](#) [9](#)

Search Display (interleaved or separately by search engine):
[Interleave](#) [Combined \\$\[a-z\]](#) [Combine \\$\[z-a\]](#)
[Separate](#) [Separate \\$\[a-z\]](#) [Separate \\$\[z-a\]](#)

Description or List (Site descriptions or lists): [\[List\]](#)



Discovery
Disney, Warner, ABC, Universal, CBS, NBC

Hot Wired
E!Online, Riddler

TV Guide
Reel.com, MusicBlvd, RealAudio, AudioNet

BuyerSellers
Ebay, DrugStore, ShopNow, Vitamin

CIA Kids
eToys, KBkds, Pets, ToysRus, PetSmart

Family
BlueMount, Women, Village, Epicurious

Weather
Intellicast, MapQuest

CitySearch
555-1212, Travelocity, Fodor's, LeisurePlan

ESPN
Sportsline, NFL, NBA, SmallWorld, NHL

CNN
NYTimes, WSJournal, USAtoday, ABCnews

StockMaster
CNNfn, Bloomberg, DowJones, Quote

CNet
ZDNet, CMPnet, IDG, Outpost, Jumbo

Monster Board
JobBank, BestJobs, Career, Incoad, Int

Search'em All: Search your favorite search engines, all at the same time*

Search 1:	<input type="text" value="Cat"/>	<input type="text" value="Amazon.com"/>
Search 2:	<input type="text" value="Cat"/>	<input type="text" value="Borders.com"/>
Search 3:	<input type="text" value="Cat"/>	<input type="text" value="BarnesandNoble.com"/>
Search 4:	<input type="text" value="Mouse"/>	<input type="text" value="Amazon.com"/>
Search 5:	<input type="text" value="Dog"/>	<input type="text" value="Amazon.com"/>
Search 6:	<input type="text" value="Dog"/>	<input type="text" value="BarnesandNoble.com"/>
Search 7:	<input type="text" value="Mouse"/>	<input type="text" value="BarnesandNoble.com"/>
Search 8:	<input type="text" value="Dog"/>	<input type="text" value="Borders.com"/>
Search 9:	<input type="text" value="Cat"/>	<input type="text" value="Google"/>

Search Engine Results: URL's per Search Engine:

URL Details: Timeout (seconds) per Search Engine:

Page: Searches per Group: Group: * Only 1 entry required

Search'em All: multiple simultaneous same* or different searches

<ul style="list-style-type: none"> Autos Buy, Cars, Racing Business Investments, Funds, Companies, Industry Careers Jobs, Universities, Education Entertainment Movies, Music, TV, Games, Chat 	<ul style="list-style-type: none"> Fashion Designers, Style, Models Health Drugs, Diseases, News Homes Food, Wine, Gardening Issues Government, Politics, Taxes, Editorials People Relationships, Dating, Psychology 	<ul style="list-style-type: none"> Society Philosophy, Economics, Religion, Sociology Sports Baseball, Basketball, Football, Hockey Technology Computers, Environment, Engineering, Internet Travel Maps, Vacations, Fares
--	--	--

Look4itHere
Div. of Internet Corporation

<ul style="list-style-type: none"> News Contests 	<ul style="list-style-type: none"> Weather Horoscopes 	<ul style="list-style-type: none"> Cool Sites Classified 	<ul style="list-style-type: none"> Shopping
--	---	--	--

Flowers for your Valentine
std.com

NOW easy ordering at
Netscape Netcenter
Click Here...

netMarket Auction VCR Spectacular

Bids start at **1**

Click Now!

February 6, 1998
NEWS ABC NEWS Headlines

U.S. Presence Growing in Iraq

Phone: 1-631-757-1600 · E-Mail: look4itHere@look4itHere.com · Internet Corporation.

FIG. 55

FIG. 56

Look4ItHere

Discovery
Disney, Warner, ABC, Universal, CBS, NBC

Hot Wired
E!Online, Riddler

TV Guide
Real.com, MusicBlvd, RealAudio, AudicNet

BuyerSellers
Ebay, DrugStore, ShopNow, Vitamin

CIA Kids
eToys, K&Kids, Pets, ToysRus, PetSmart

Family
BlueMount, Women, Village, Epicurious

Weather
Intellicast, MapQuest

CitySearch
555-1212, Travelocity, Fodor's, LeisurePlan

ESPN
SportsLine, NFL, NBA, SmallWorld, NHL

CNN
NYTimes, WSJournal, USAtoday, ABCnews

StockMaster
CNNfn, Bloomberg, DowJones, Quote

CNet
ZDNet, CMPnet, IDG, Outpost, Jumbo

Monster Board
JobBank, BestJobs, Career, Inepad, Intl

Search'em All: Search your favorite search engines, all at the same time!

Search 1:	<input type="text"/>	WebCrawler
Search 2:	<input type="text"/>	Altavista
Search 3:	<input type="text"/>	Lycos
Search 4:	<input type="text"/>	Google
Search 5:	<input type="text"/>	Excite
Search 6:	<input type="text"/>	Yahoo
Search 7:	<input type="text"/>	LookSmart
Search 8:	<input type="text"/>	HotBot
Search 9:	<input type="text"/>	Dejanews

Search Engine Results: URL's per Search Engine:

URL Details: Timeout (seconds) per Search Engine:

Page: Searches per Group: Group: Only 1 entry required

Flowers for your Valentine
rca.com

NOW easy ordering at
N Netscape Netcenter
[Click Here...](#)

netMarket Auction
VCR Spectacular

Bids start at \$1

[Click Now!](#)

February 6, 1998
NEWS ABC NEWS Headlines

U.S. Presence Growing in Iraq

Search Engine Report Order Quantity Below

Query: Cat

- I) 1) TICA Website**
WELCOME TO THE WEB SITE OF THE INTERNATIONAL CAT ASSOCIATION To Navigate the Site Frames No Frames Please See this page as a Shockwave movie ...
<http://www.fica.org/> (google)
- I) 2) The Cat Fanciers' Association (CFA)**
Welcome to the Cat Fanciers' Association, the world's largest registry of pedigreed cats! ...
<http://www.cfanc.org/> (google)
- I) 3) Feral Cat Coalition**
Feral Cat Coalition, San Diego, California. Please follow these links for more information on the subject: Feral Cat Coalition Documents. ...
<http://www.feralcat.com/> (google)
- I) 4) Cat Tales Zoological Park**
LATEST UPDATE: October 20, 2000. Cat Tales Zoological Park. Do you have what it takes to become a zookeeper? Cat Tales Zoological Training Center. ...
<http://www.cattales.org/> (google)
- I) 5) Cat Fancy**
or killed playing with toy mice distributed in packages of Fresh Step cat litter, Clorox Co., Oakland, Calif., warned pet owners the toys could strangle or cut ...
<http://www.animalnetwork.com/cats/default.asp> (google)
- I) 6) Cat Fanciers Web Site**
Welcome to the Cat Fanciers Web Site! We offer General Information about Cats and Cat Care., Cat Breed Descriptions from Abyssinian to Turkish Van, ...
<http://www.fanciers.com/> (google)
- I) 7) Cat-Scan.Com - The Cover Page**
Welcome to CliffyB's Cat-Scan! Cat-Scan is home to people who love art as much as their cats. So much so, they combine the two! Every weekday we'll bring you ...
<http://www.cat-scan.com/> (google)
- I) 8) Beware of Cat! HUGE Cat Graphics Collection & Virtual Cat ...**
Cat Postcards! Send an electronic Cat Postcard Now! Hundreds of cute cat cards to choose from! Holidays, Kittens, Cartoons, Love & More! Add Music, Backgrounds ...
<http://www.geocities.com/Hearthand/Meadows/6485/> (google)
- I) 9) Arctic Cat > What Drives You to the Great Outdoors?**
Arctic Cat. Snowmobile ATV Watercraft Generators Catalogs. What's new on the site? Click ...
<http://www.arctic-cat.com/> (google)
- I) 10) Alley Cat Allies**
Alley Cat Allies Has a Better Idea. Modeled after successful programs in the United Kingdom and parts of Africa and Europe, Alley Cat Allies (ACA) advocates a ...
<http://www.alleycat.org/> (google)
- I) 11) Textbook of Veterinary Internal Medicine: Diseases of the Dog and Cat (2-Volume Set)**
Usually ships in 24 hours
by Stephen J. Ettinger(Editor), Edward C. Feldman(Editor)(Hardcover)
Amazon Price: \$195.00...
<http://www.amazon.com/exec/obidos/ASIN/0721672566/qid=981919816/s...> (amazon)
- I) 12) Accreditation of Teacher Education: The Story of CATE 1984-1989**
In stock - ships in 24 hours
MacIntyre, Gordon ~ Trade Paperback ~ 1991
Borders Price: \$34.95 ...
<http://search.borders.com/cgi-bin/db2www/search/search.d2w/Detail...> (borders)
- I) 13) Gmat 2000-2001 (Gmat Cat (Kaplan)(Book & Cd-Rom))**
Usually ships in 24 hours
(Paperback - March 2000)
Amazon Price: \$29.60...
<http://www.amazon.com/exec/obidos/ASIN/0684870088/qid=981919816/s...> (amazon)
- I) 14) Cracking the GMAT CAT with CD-ROM, 2001 Edition**

In-Stock: Ships 2-3 days.
 Geoff Martz / Paperback / Princeton Review Publishing Corporation / June 2000
 B&N Price: \$27.96 ~ You Save 20%...
<http://shop.barnesandnoble.com/booksearch/sbnInquiry.asp?userid=...> (barnesandnoble)

I) 15) Cracking the Gmat 2001 (Cracking the Gmat Cat With Sample Tests on Cd-Rom)

Usually ships in 24 hours
 by Martz, Geoff Martz(Paperback - June 2000)
 Amazon Price: \$27.96...
<http://www.amazon.com/exec/obidos/ASIN/0375756248/qid=981919816/s...> (amazon)

I) 16) Cracking the GRE CAT with CD-ROM, 2001 Edition

In Stock: 24 hours (Same Day).
 Karen Lurie / Paperback / Princeton Review Publishing Corporation / June 2000
 B&N Price: \$24.80 ~ You Save 20%...
<http://shop.barnesandnoble.com/booksearch/sbnInquiry.asp?userid=...> (barnesandnoble)

I) 17) The Cat Who Smelled a Rat

In Stock: 24 hours (Same Day).
 Lillian Jackson Braun / Hardcover / Penguin Putnam / January 2001
 B&N Price: \$19.16 ~ You Save 20%...
<http://shop.barnesandnoble.com/booksearch/sbnInquiry.asp?userid=...> (barnesandnoble)

I) 18) The Cat Who Smelled a Rat

Usually ships in 24 hours
 by Lillian Jackson Braun(Hardcover - January 2001)
 Amazon Price: \$19.16...
<http://www.amazon.com/exec/obidos/ASIN/0399146652/qid=981919816/s...> (amazon)

I) 19) Arthur's World of Cats

In stock - ships in 24 hours
 Head, Ann ~ Hardcover ~ 1997
 Borders Price: \$18.36 ~ You Save: \$4.59 (20%)...
<http://search.borders.com/cgi-bin/db2www/search/search.d2w/Detail...> (borders)

I) 20) The Cat Who Covered the World : The Adventures of Henrietta and Her Foreign Correspondent

Usually ships in 24 hours
 by Christopher S. Wren(Hardcover - November 2000)
 Amazon Price: \$16.80...
<http://www.amazon.com/exec/obidos/ASIN/0684871009/qid=981919816/s...> (amazon)

I) 21) The Cat Who Smelled a Rat [ABRIDGED]

Usually ships in 24 hours
 by Lillian Jackson Braun(Audio Cassette - January 2001)
 Amazon Price: \$16.15...
<http://www.amazon.com/exec/obidos/ASIN/0399146814/qid=981919816/s...> (amazon)

I) 22) All about Himalayan Cats

In stock - ships in 24 hours
 Bearley, Joan M. ~ Hardcover ~ 1989
 Borders Price: \$14.36 ~ You Save: \$3.59 (20%)...
<http://search.borders.com/cgi-bin/db2www/search/search.d2w/Detail...> (borders)

I) 23) Alfie & the Birthday Surprise

In stock - ships in 24 hours
 Hughes, Shirley ~ Hardcover ~ 1998
 Borders Price: \$12.80 ~ You Save: \$3.20 (20%)...
<http://search.borders.com/cgi-bin/db2www/search/search.d2w/Detail...> (borders)

I) 24) Cat Heaven

Usually ships in 24 hours
 by Cynthia Rylant(illustrator)(School & Library Binding - September 1997)
 Amazon Price: \$12.76...
<http://www.amazon.com/exec/obidos/ASIN/0590100548/qid=981919816/s...> (amazon)

I) 25) Aloha, Dolores

In stock - ships in 24 hours
 Samuels, Barbara ~ Hardcover ~ 2000
 Borders Price: \$12.76 ~ You Save: \$3.19 (20%)...
<http://search.borders.com/cgi-bin/db2www/search/search.d2w/Detail...> (borders)

I) 26) Master the Gre Cat 2001 (Master the Gre. 2001)

Usually ships in 2-3 days
 by Thomas H. Martinson(Paperback - November 2000)
 Amazon Price: \$11.16...
<http://www.amazon.com/exec/obidos/ASIN/0764561197/qid=981919816/s...> (amazon)

I) 27) Eating the Cheshire Cat

Usually ships in 24 hours
 by Helen Ellis(Paperback - February 2001)
 Amazon Price: \$10.40...
<http://www.amazon.com/exec/obidos/ASIN/068486441X/qid=981919816/s...> (amazon)

I) 28) 260 Things You Can Do to Make Your Cat Adore You

In stock - ships in 24 hours
 Newkirk, Ingrid ~ Trade Paperback ~ 1998
 Borders Price: \$9.90 ~ You Save: \$1.10 (10%)...
<http://search.borders.com/cgi-bin/db2www/search/search.d2w/Detail...> (borders)

I) 29) How to Live with a Neurotic Cat

In Stock: 24 hours (Same Day).
 Stephen Baker / Hardcover / Random House Value Publishing, incorporated / September 1999
 B&N Price: \$7.99...
<http://shop.barnesandnoble.com/booksearch/sbnInquiry.asp?userid=...> (barnesandnoble)

I) 30) Bedtime Stories for Cats

In stock - ships in 24 hours
 Jasheway, Leigh A. ~ Hardcover ~ 1997
 Borders Price: \$7.96 ~ You Save: \$1.99 (20%)...
<http://search.borders.com/cgi-bin/db2www/search/search.d2w/Detail...> (borders)

I) 31) Adopting Cats & Kittens: A Care & Training Guide

Ships within 2-3 days
 Jankowski, Connie ~ Trade Paperback ~ 1993
 Borders Price: \$7.20 ~ You Save: \$0.80 (10%)...

<http://search.borders.com/fcgi-bin/db2www/search/search.d2w/Detai...> (borders)

I) 32) The Cat in the Hat (Classic Gift Seuss Series)

In Stock: 24 hours (Same Day).
Dr. Seuss / Hardcover / Random House, Incorporated / May 1976
B&N Price: \$6.39 ~ You Save 20%...
<http://shop.barnesandnoble.com/booksearch/isbnInquiry.asp?userid=...> (barnesandnoble)

I) 33) Animal Clinic for Cats

In stock - ships in 24 hours
Humphries, Jim ~ Hardcover ~ 1998
Borders Price: \$6.39 ~ You Save: \$1.60 (20%)...
<http://search.borders.com/fcgi-bin/db2www/search/search.d2w/Detai...> (borders)

I) 34) The Cat Who Robbed a Bank

In Stock: 24 hours (Same Day).
Lilian Jackson Braun / Paperback / Berkley Publishing Group / January 2001
B&N Price: \$6.29 ~ You Save 10%...
<http://shop.barnesandnoble.com/booksearch/isbnInquiry.asp?userid=...> (barnesandnoble)

I) 35) Pawing Through the Past (Age of Unreason)

Usually ships in 24 hours
by Rita Mae Brown, Sneaky Pie Brown(Mass Market Paperback - January 2001)
Amazon Price: \$6.29...
<http://www.amazon.com/exec/obidos/ASIN/0553580256/qid=981919816/s...> (amazon)

I) 36) Abysianian Cats: Everything about Acquisition, Care, Nutrition, Behaviour, Health Care, & Breeding

In stock - ships in 24 hours
Hauppauge, J. Anne ~ Trade Paperback ~ 1995
Borders Price: \$6.26 ~ You Save: \$0.89 (10%)...
<http://search.borders.com/fcgi-bin/db2www/search/search.d2w/Detai...> (borders)

I) 37) 2001 Classic Cats Wall Calendar

In Stock: 24 hours.
Cal 2001 / Wall Calendar / June 2000
B&N Price: \$5.97 ~ You Save 50%...
<http://shop.barnesandnoble.com/booksearch/isbnInquiry.asp?userid=...> (barnesandnoble)

I) 38) 2001 Original 365 Cats Page-A-Day Calendar

In Stock: 24 hours.
Cal 2001 / Box Calendar / Workman Publishing Company, Inc. / June 2000
B&N Price: \$5.47 ~ You Save 50%...
<http://shop.barnesandnoble.com/booksearch/isbnInquiry.asp?userid=...> (barnesandnoble)

I) 39) 2001 Hello Kitty Wall Calendar

In Stock: 24 hours.
Cal 2001 (Illustrator) / Wall Calendar / Abrams,Harry N Inc / June 2000
B&N Price: \$4.97 ~ You Save 50%...
<http://shop.barnesandnoble.com/booksearch/isbnInquiry.asp?userid=...> (barnesandnoble)

I) 40) Cat's Letters to Santa

In Stock: 24 hours (Same Day).
Bill Adler (Editor), Paul Bacon (Illustrator) / Hardcover / Galahad Books / September 1997
B&N Price: \$2.99 ~ You Save 50%...
<http://shop.barnesandnoble.com/booksearch/isbnInquiry.asp?userid=...> (barnesandnoble)

Query: Mouse

I) 1) The Atlas of the Mouse Development

Usually ships in 24 hours
by Matthew H. Kaufman(Hardcover - October 1997)
Amazon Price: \$225.00...
<http://www.amazon.com/exec/obidos/ASIN/0124020356/qid=981919816/s...> (amazon)

I) 2) The Anatomical Basis of Mouse Development

Usually ships in 24 hours
by Matthew H. Kaufman, Jonathan B. L. Bard(Hardcover - March 1999)
Amazon Price: \$99.95...
<http://www.amazon.com/exec/obidos/ASIN/0124020607/qid=981919816/s...> (amazon)

I) 3) What's Wrong with My Mouse?: Behavioral Phenotyping of Transgenic and Knockout Mice

Usually ships in 24 hours
by Jacqueline N., Phd Crawley(Hardcover)
Amazon Price: \$79.95...
<http://www.amazon.com/exec/obidos/ASIN/0471316393/qid=981919816/s...> (amazon)

I) 4) Craft Lessons: Teaching Writing K through 8

In Stock: 24 hours.
Ralph J. Fletcher, Joann Portalupi / Paperback / Stenhouse Publishers / September 1998
B&N Price: \$17.50...
<http://shop.barnesandnoble.com/booksearch/isbnInquiry.asp?userid=...> (barnesandnoble)

I) 5) If You Take a Mouse to the Movies

In Stock: 24 hours.
Laura Joffe Numeroff, Felicia Bond (Illustrator) / Hardcover / HarperCollins Children's Books / September 2000
B&N Price: \$12.76 ~ You Save 20%...
<http://shop.barnesandnoble.com/booksearch/isbnInquiry.asp?userid=...> (barnesandnoble)

I) 6) If You Take a Mouse to the Movies

Usually ships in 24 hours
by Felicia Bond(Illustrator), Laura Joffe Numeroff(Hardcover - October 2000)
Amazon Price: \$12.76...
<http://www.amazon.com/exec/obidos/ASIN/0060278676/qid=981919816/s...> (amazon)

I) 7) If You Give a Mouse a Cookie

Usually ships in 24 hours
by Felicia Bond(Illustrator), Laura Joffe Numeroff(Hardcover - May 1985)
Amazon Price: \$12.76...
<http://www.amazon.com/exec/obidos/ASIN/0080245887/qid=981919816/s...> (amazon)

I) 8) The Mouse of Amherst

Usually ships in 24 hours
by Elizabeth Spires, Claire A. Nivola(Illustrator)(Hardcover - March 1999)
Amazon Price: \$12.00...
<http://www.amazon.com/exec/obidos/ASIN/0374350833/qid=981919816/s...> (amazon)

I) 9) If You Give a Mouse a Cookie

In Stock: 24 hours (Same Day).
 Laura Joffe Numeroff, Felicia Bond (Illustrator) / Hardcover / HarperCollins Children's Books / January 1985
 B&N Price: \$11.96 ~ You Save 20%...
<http://shop.barnesandnoble.com/booksearch/sbnInquiry.asp?userid=...> (barnesandnoble)

I) 10) Mouse Count

Usually ships in 1-2 weeks
 by Ellen Stoll Walsh, Diane D'Andrade(Editor)(School & Library Binding - March 1991)
 Amazon Price: \$10.40...
<http://www.amazon.com/exec/obidos/ASIN/0152560238/qid=981919816/s...> (amazon)

I) 11) If You Give a Mouse a Cookie Mini Book and Ornament

In Stock: 24 hours.
 Laura Joffe Numeroff, Felicia Bond (Illustrator) / Hardcover / HarperCollins Children's Books / September 2000
 B&N Price: \$7.98 ~ You Save 20%...
<http://shop.barnesandnoble.com/booksearch/sbnInquiry.asp?userid=...> (barnesandnoble)

I) 12) Cat & Mouse

In Stock: 24 hours (Same Day).
 James Patterson / Mass Market Paperback / Warner Books, Incorporated / October 1998
 B&N Price: \$7.19 ~ You Save 10%...
<http://shop.barnesandnoble.com/booksearch/sbnInquiry.asp?userid=...> (barnesandnoble)

I) 13) Cat & Mouse

Usually ships in 24 hours
 by James Patterson(Mass Market Paperback - October 2000)
 Amazon Price: \$7.19...
<http://www.amazon.com/exec/obidos/ASIN/0446806189/qid=981919816/s...> (amazon)

I) 14) Ben and Me : A New and Astonishing Life of Benjamin Franklin As Written by His Good Mouse Amos

Usually ships in 24 hours
 by Robert Lawson(Illustrator)(Paperback - April 1988)
 Amazon Price: \$5.35...
<http://www.amazon.com/exec/obidos/ASIN/0316517305/qid=981919816/s...> (amazon)

I) 15) Mouse Count

Usually ships in 24 hours
 by Ellen Stoll Walsh(Paperback - March 1995)
 Amazon Price: \$4.95...
<http://www.amazon.com/exec/obidos/ASIN/0152002235/qid=981919816/s...> (amazon)

I) 16) The Mouse and the Motorcycle

In Stock: 24 hours (Same Day).
 Beverly Cleary, Louis Darling (Illustrator) / Paperback / Morrow, William & Co / August 1990
 B&N Price: \$4.45 ~ You Save 10%...
<http://shop.barnesandnoble.com/booksearch/sbnInquiry.asp?userid=...> (barnesandnoble)

I) 17) Disney's Toy Story: Movie Storybook

In Stock: 24 hours (Same Day).
 Mouse Works Staff / Hardcover / Disney Enterprises, Incorporated / May 2000
 B&N Price: \$3.98 ~ You Save 42%...
<http://shop.barnesandnoble.com/booksearch/sbnInquiry.asp?userid=...> (barnesandnoble)

I) 18) Santa Mouse Where Are You

In Stock: 24 hours (Same Day).
 Michael Brown, Elfrieda DeWitt (Illustrator) / Hardcover / Barnes & Noble Books / August 1997
 B&N Price: \$2.49 ~ You Save 50%...
<http://shop.barnesandnoble.com/booksearch/sbnInquiry.asp?userid=...> (barnesandnoble)

I) 19) Santa Mouse

In Stock: 24 hours (Same Day).
 Michael Brown, Elfrieda DeWitt (Illustrator) / Hardcover / Barnes & Noble Books / August 1996
 B&N Price: \$2.49 ~ You Save 50%...
<http://shop.barnesandnoble.com/booksearch/sbnInquiry.asp?userid=...> (barnesandnoble)

I) 20) Santa Mouse Coloring and Pencil Puzzle Book

In Stock: 24 hours (Same Day).
 Michael Brown / Paperback / Barnes & Noble Books / July 1999
 B&N Price: \$1.49 ~ You Save 50%...
<http://shop.barnesandnoble.com/booksearch/sbnInquiry.asp?userid=...> (barnesandnoble)

Query: Dog

I) 1) Advanced Gundog Training: Practical Fieldwork & Competition

In stock - ships in 24 hours
 Deeley, Martin ~ Hardcover ~ 1994
 Borders Price: \$27.96 ~ You Save: \$6.98 (20%)...
<http://search.borders.com/cgi-bin/db2www/search/search.d2w/Data...> (borders)

I) 2) Agility Training: The Fun Sport for All Dogs

In stock - ships in 24 hours
 Simmons-Moake, Jane ~ Trade Paperback ~ 1992
 Borders Price: \$23.36 ~ You Save: \$2.59 (10%)...
<http://search.borders.com/cgi-bin/db2www/search/search.d2w/Data...> (borders)

I) 3) American Staffordshire Terrier: Gamester & Guardian

In stock - ships in 24 hours
 Foster, Sarah ~ Trade Paperback ~ 1998
 Borders Price: \$22.46 ~ You Save: \$2.49 (10%)...
<http://search.borders.com/cgi-bin/db2www/search/search.d2w/Data...> (borders)

I) 4) A-Z of Dog Diseases & Health Problems

In stock - ships in 24 hours
 Lane, Dick ~ Trade Paperback ~ 1997
 Borders Price: \$22.46 ~ You Save: \$2.49 (10%)...
<http://search.borders.com/cgi-bin/db2www/search/search.d2w/Data...> (borders)

I) 5) The Dog Owners Home Veterinary Handbook

Usually ships in 2-3 days
 by James M. Giffin, et al(Hardcover - November 1999)
 Amazon Price: \$22.36...
<http://www.amazon.com/exec/obidos/ASIN/0876052014/qid=981919816/s...> (amazon)

I) 6) Family Dog : 16 Weeks to a Well-Mannered Dog-A Simple and Time-Proven Method

Usually ships in 24 hours
by Richard A. Wolters, Red Smith(Introduction)(Hardcover - February 1999)
Amazon Price: \$22.36...
<http://www.amazon.com/exec/obidos/ASIN/0525944729/qid=981919816/s...> (amazon)

I) 7) Going for the Blue: Inside the World of Show Dogs and Dog Shows

Usually ships in 24 hours
by Roger A. Caras(Hardcover - February 2001)
Amazon Price: \$20.76...
<http://www.amazon.com/exec/obidos/ASIN/0446526444/qid=981919816/s...> (amazon)

I) 8) How to Be Your Dog's Best Friend : A Training Manual for Dog Owners

Usually ships in 24 hours
by New Skete Monks, et al(Hardcover - October 1978)
Amazon Price: \$19.16...
<http://www.amazon.com/exec/obidos/ASIN/0316604917/qid=981919816/s...> (amazon)

I) 9) Dog Training for Dummies (For Dummies)

Usually ships in 24 hours
by John Volhard, et al(Paperback - January 2001)
Amazon Price: \$17.59...
<http://www.amazon.com/exec/obidos/ASIN/0764552864/qid=981919816/s...> (amazon)

I) 10) Baby's Memory Book: A Baby Record Book

In stock - ships in 24 hours
Nister, Emeet ~ Hardcover ~ 1986
Borders Price: \$15.99 ~ You Save: \$4.00 (20%)...
<http://search.borders.com/cgi-bin/db2www/search/search.d2w/Detail...> (borders)

I) 11) Dog: The Complete Guide

In Stock: 24 hours (Same Day).
Sarah Whitehead / Hardcover / Barnes & Noble Books / August 1999
B&N Price: \$14.98...
<http://shop.barnesandnoble.com/booksearch/sbnInquiry.asp?userid=...> (barnesandnoble)

I) 12) Let the Big Dog Eat : A Dictionary of the Secret Language of Golf

Usually ships in 24 hours
by Hubert Pedrolli, et al(Hardcover - June 2000)
Amazon Price: \$14.40...
<http://www.amazon.com/exec/obidos/ASIN/0688175767/qid=981919816/s...> (amazon)

I) 13) Anastasia, Absolutely

In stock - ships in 24 hours
Lowry, Lois ~ Hardcover ~ 1995
Borders Price: \$12.80 ~ You Save: \$3.20 (20%)...
<http://search.borders.com/cgi-bin/db2www/search/search.d2w/Detail...> (borders)

I) 14) The Stray Dog

Usually ships in 24 hours
by Marc Simont(Illustrator), Reiko Sassa(Hardcover - January 2001)
Amazon Price: \$12.76...
<http://www.amazon.com/exec/obidos/ASIN/0060289333/qid=981919816/s...> (amazon)

I) 15) Dog Heaven

Usually ships in 24 hours
by Cynthia Rylant(Illustrator)(School & Library Binding - September 1995)
Amazon Price: \$12.76...
<http://www.amazon.com/exec/obidos/ASIN/0590417010/qid=981919816/s...> (amazon)

I) 16) Bark Busters: Solving Your Dog's Behavioral Problems

In stock - ships in 24 hours
Wilson, Sylvia ~ Trade Paperback ~ 1997
Borders Price: \$11.66 ~ You Save: \$1.29 (10%)...
<http://search.borders.com/cgi-bin/db2www/search/search.d2w/Detail...> (borders)

I) 17) Adopting the Racing Greyhound

In stock - ships in 24 hours
Branigan, Cynthia A. ~ Trade Paperback ~ 1998
Borders Price: \$11.66 ~ You Save: \$1.29 (10%)...
<http://search.borders.com/cgi-bin/db2www/search/search.d2w/Detail...> (borders)

I) 18) How to Live with a Neurotic Dog

In Stock: 24 hours (Same Day).
Stephen Baker, Fred Hilliard (Illustrator) / Hardcover / Random House, Incorporated / February 1995
B&N Price: \$7.99...
<http://shop.barnesandnoble.com/booksearch/sbnInquiry.asp?userid=...> (barnesandnoble)

I) 19) 2001 Man's Best Friend Wall Calendar

In Stock: 24 hours.
Cal 2001, William Wegman (Photographer) / Wall Calendar / Abrams, Harry N Inc / June 2000
B&N Price: \$6.47 ~ You Save 50%...
<http://shop.barnesandnoble.com/booksearch/sbnInquiry.asp?userid=...> (barnesandnoble)

I) 20) Animal Clinic for Dogs

In stock - ships in 24 hours
Humphries, Jim ~ Hardcover ~ 1998
Borders Price: \$6.39 ~ You Save: \$1.60 (20%)...
<http://search.borders.com/cgi-bin/db2www/search/search.d2w/Detail...> (borders)

I) 21) How to Housebreak Your Dog in 7 Days

Usually ships in 24 hours
by Shirlee Kalstone(Paperback - April 1991)
Amazon Price: \$6.29...
<http://www.amazon.com/exec/obidos/ASIN/0553346156/qid=981919816/s...> (amazon)

I) 22) 2001 William Wegman Puppies Wall Calendar

In Stock: 24 hours.
Cal 2001 / Wall Calendar / Abrams, Harry N Inc / June 2000
B&N Price: \$6.47 ~ You Save 50%...
<http://shop.barnesandnoble.com/booksearch/sbnInquiry.asp?userid=...> (barnesandnoble)

I) 23) 2001 Original 365 Dogs Page-A-Day Calendar

In Stock: 24 hours.
Cal 2001 / Box Calendar / Workman Publishing Company, Inc. / August 2000
B&N Price: \$5.47 ~ You Save 50%...

<http://shop.barnesandnoble.com/booksearch/isbnInquiry.asp?userid=...> (barnesandnoble)

I) 24) Ginger Pye
 In Stock: 24 hours (Same Day).
 Eleanor Estes / Paperback / Harcourt / September 2000
 B&N Price: \$5.40 ~ You Save 10%...
<http://shop.barnesandnoble.com/booksearch/isbnInquiry.asp?userid=...> (barnesandnoble)

I) 25) Where the Red Fern Grows
 In Stock: 24 hours (Same Day).
 Wilson Rawls / Mass Market Paperback / Bantam Books, Incorporated / May 1981
 B&N Price: \$5.39 ~ You Save 10%...
<http://shop.barnesandnoble.com/booksearch/isbnInquiry.asp?userid=...> (barnesandnoble)

I) 26) Clifford: The Big Red Dog
 In Stock: 24 hours (Same Day).
 Norman Bridwell / Board Book / Scholastic, Inc. / July 1997
 B&N Price: \$4.79 ~ You Save 20%...
<http://shop.barnesandnoble.com/booksearch/isbnInquiry.asp?userid=...> (barnesandnoble)

I) 27) Stone Fox (Harper Trophy Book)
 Usually ships in 24 hours
 by John Reynolds Gardiner, Marcia Sewall (Illustrator) (Paperback - February 1988)
 Amazon Price: \$4.45...
<http://www.amazon.com/exec/obidos/ASIN/0064401324/qid=981919816/s...> (amazon)

I) 28) Tigers at Twilight: (Magic Tree House Series #19)
 In Stock: 24 hours (Same Day).
 Mary Pope Osborne, Sal Murdocca (Illustrator) / Paperback / Random House Books for Young Readers / August 1999
 B&N Price: \$3.59 ~ You Save 10%...
<http://shop.barnesandnoble.com/booksearch/isbnInquiry.asp?userid=...> (barnesandnoble)

I) 29) Baby Animals: Puppies
 In stock - ships in 24 hours
 Petty, Kate ~ Trade Paperback ~ 1992
 Borders Price: \$3.56 ~ You Save: \$0.39 (10%)...
<http://search.borders.com/cgi-bin/db2www/search/search.d2w/Detail...> (borders)

I) 30) Clifford's First Valentine's Day
 In-Stock: Ships 2-3 days.
 Norman Bridwell / Paperback / Scholastic, Inc. / November 1996
 B&N Price: \$2.69 ~ You Save 10%...
<http://shop.barnesandnoble.com/booksearch/isbnInquiry.asp?userid=...> (barnesandnoble)

Look4ItHere
 Div. of Internet Corporation
 News Weather Cool Sites Shopping
 Contests Horoscopes Classified
 Visit [Look4ItHere2](#)

Phone: 1-631-757-1600 • E-Mail: look4itthere@look4itthere.com • Internet Corporation.

Current Group: I

amazon1	borders2	barnesandnoble3	amazon4	amazon5	barnesandnoble6	barnesandnoble7	borders8	google9
Cat	Cat	Cat	Mouse	Dog	Dog	Mouse	Dog	Cat

Go to page: [1](#) [2](#) [3](#) [4](#) [5](#) [6](#) [7](#) [8](#) [9](#)

Search Display (Interleaved or separately by search engine):
[Interleave](#) [Combine \\$\[a-z\]](#) [Combined \\$\[z-a\]](#)
[Separate](#) [Separate \\$\[a-z\]](#) [Separate \\$\[z-a\]](#)

Description or List (Site descriptions or lists): [List](#)



Discovery
[Disney](#), [Warner](#), [ABC](#),
[Universal](#), [CBS](#), [NBC](#)

Hot Wired
[E!Online](#), [Riddler](#)

TV Guide
[Reel.com](#), [MusicBlvd](#),
[RealAudio](#), [AudioNet](#)

BuyerSellers
[Ebay](#), [DrugStore](#),
[ShopNow](#), [Vitamin](#)

CIA Kids
[eToys](#), [KBkids](#), [Pets](#),
[ToysRus](#), [PetSmart](#)

Family
[BlueMount](#), [Women](#),
[Village](#), [Epicurious](#)

Weather
[Intellicast](#), [MapQuest](#)

CitySearch
[555-1212](#), [Travelocity](#),
[Fodor's](#), [LeisurePlan](#)

ESPN
[SportsLine](#), [NFL](#), [NBA](#),
[SmallWorld](#), [NHL](#)

CNN
[NYTimes](#), [WSJournal](#),
[USAtoday](#), [ABCnews](#)

StockMaster
[CNNfn](#), [Bloomberg](#),
[DowJones](#), [Quote](#)

CNet
[ZDNet](#), [CMPnet](#), [IDG](#),
[Outpost](#), [Jumbo](#)

Monster Board
[JobBank](#), [BestJobs](#),
[Career](#), [Incpad](#), [Intl](#)

Search'em All: Search your favorite search engines, all at the same time*

Search 1:	<input type="text" value="Cat"/>	<input type="text" value="Amazon.com"/>
Search 2:	<input type="text" value="Cat"/>	<input type="text" value="Borders.com"/>
Search 3:	<input type="text" value="Cat"/>	<input type="text" value="BarnesandNoble.com"/>
Search 4:	<input type="text" value="Mouse"/>	<input type="text" value="Amazon.com"/>
Search 5:	<input type="text" value="Dog"/>	<input type="text" value="Amazon.com"/>
Search 6:	<input type="text" value="Dog"/>	<input type="text" value="BarnesandNoble.com"/>
Search 7:	<input type="text" value="Mouse"/>	<input type="text" value="BarnesandNoble.com"/>
Search 8:	<input type="text" value="Dog"/>	<input type="text" value="Borders.com"/>
Search 9:	<input type="text" value="Cat"/>	<input type="text" value="Google"/>

Search Engine Results: URL's per Search Engine:

URL Details: Timeout (seconds) per Search Engine:

Page: Searches per Group: Group: * Only 1 entry required

Search'em All: multiple simultaneous same* or different searches

- **Autos**
[Buy](#), [Cars](#), [Racing](#)
- **Business**
[Investments](#), [Funds](#),
[Companies](#), [Industry](#)
- **Careers**
[Jobs](#), [Universities](#),
[Education](#)
- **Entertainment**
[Movies](#), [Music](#), [TV](#),
[Games](#), [Chat](#)
- **Fashion**
[Designers](#), [Style](#), [Models](#)
- **Health**
[Drugs](#), [Diseases](#), [News](#)
- **Homes**
[Food](#), [Wine](#), [Gardening](#)
- **Issues**
[Government](#), [Politics](#),
[Taxes](#), [Editorials](#)
- **People**
[Relationships](#), [Dating](#),
[Psychology](#)
- **Society**
[Philosophy](#), [Economics](#),
[Religion](#), [Sociology](#)
- **Sports**
[Baseball](#), [Basketball](#),
[Football](#), [Hockey](#)
- **Technology**
[Computers](#), [Environment](#),
[Engineering](#), [Internet](#)
- **Travel**
[Maps](#), [Vacations](#), [Fares](#)

Look4itHere
 Div. of Internet Corporation

- [News](#)
- [Weather](#)
- [Cool Sites](#)
- [Shopping](#)
- [Contests](#)
- [Horoscopes](#)
- [Classified](#)

Flowers for your Valentine
[std.com](#)
 NOW easy ordering at

 Click Here...

netMarket Auction
 VCR Spectacular

 Bids start at 1
 Click Now!

February 6, 1998
 NEWS ABC NEWS Headlines
 U.S. Presence Growing In Iraq

Phone: 1-631-757-1600 · E-Mail: look4itHere@look4itHere.com
 Internet Corporation.

FIG. 57

FIG. 58

Look4ItHere

Search'em All: Search your favorite search engines, all at the same time!

Search 1: WebCrawler
 Search 2: Altavista
 Search 3: Lycos
 Search 4: Google
 Search 5: Excite
 Search 6: Yahoo
 Search 7: LookSmart
 Search 8: HotBot
 Search 9: Dejanews

Search Engine Results: URL's per Search Engine:
 URL Details: Timeout (seconds) per Search Engine:
 Page: Searches per Group: Group: Only 1 entry required

Discovery
 Disney, Warner, AEC, Universal, CBS, NBC

Hot Wired
 E!Online, Riddler

TV Guide
 Real.com, MusicBlvd, RealAudio, AudioNet

BuyerSellers
 Ebay, DrugStore, ShopNow, Vitamin

CHA Kids
 eToys, K&Kids, Pets, ToysRus, PetSmart

Family
 BlueMount, Women, Village, Epicurious

Weather
 Intellicast, MapQuest

CitySearch
 555-1212, Travelocity, Fodor's, LeisurePlan

ESPN
 SportsLine, NFL, NBA, SmallWorld, NHL

CNN
 NYTimes, WSJournal, USAtoday, ABCnews

StockMaster
 CNNfn, Bloomberg, DowJones, Quote

CNet
 ZDNet, CMPnet, IDG, Outpost, Jumbo

Monster Board
 JobBank, BestJobs, Career, Incpad, Inti

Search Engine Report

Search Engine 1: amazon1
Query1: Cat

Search Engine Report	Order Quantity Below
I) 1) Pawing Through the Past (Age of Unreason) Usually ships in 24 hours by Rita Mae Brown, Sneaky Pie Brown(Mass Market Paperback - January 2001) Amazon Price: \$6.29... http://www.amazon.com/exec/obidos/ASIN/0553580256/qid=981919875/s... (amazon)	<input type="checkbox"/>
I) 2) Eating the Cheshire Cat Usually ships in 24 hours by Helen Ellis(Paperback - February 2001) Amazon Price: \$10.40... http://www.amazon.com/exec/obidos/ASIN/068480441X/qid=981919875/s... (amazon)	<input type="checkbox"/>
I) 3) Master the Gre Cat 2001 (Master the Gre, 2001) Usually ships in 2-3 days by Thomas H. Martinson(Paperback - November 2000) Amazon Price: \$11.16... http://www.amazon.com/exec/obidos/ASIN/0764561197/qid=981919875/s... (amazon)	<input type="checkbox"/>
I) 4) Cat Heaven Usually ships in 24 hours by Cynthia Rylant(Illustrator)(School & Library Binding - September 1997) Amazon Price: \$12.76... http://www.amazon.com/exec/obidos/ASIN/0590100548/qid=981919875/s... (amazon)	<input type="checkbox"/>
I) 5) The Cat Who Smelled a Rat [ABRIDGED] Usually ships in 24 hours by Lillian Jackson Braun(Audio Cassette - January 2001) Amazon Price: \$16.15... http://www.amazon.com/exec/obidos/ASIN/0399146814/qid=981919875/s... (amazon)	<input type="checkbox"/>
I) 6) The Cat Who Covered the World : The Adventures of Henrietta and Her Foreign Correspondent Usually ships in 24 hours by Christopher S. Wren(Hardcover - November 2000) Amazon Price: \$16.80... http://www.amazon.com/exec/obidos/ASIN/0684871009/qid=981919875/s... (amazon)	<input type="checkbox"/>
I) 7) The Cat Who Smelled a Rat Usually ships in 24 hours by Lillian Jackson Braun(Hardcover - January 2001) Amazon Price: \$19.16... http://www.amazon.com/exec/obidos/ASIN/0399146652/qid=981919875/s... (amazon)	<input type="checkbox"/>
I) 8) Cracking the Gmat 2001 (Cracking the Gmat Cat With Sample Tests on Cd-Rom) Usually ships in 24 hours by Martz, Geoff Martz(Paperback - June 2000) Amazon Price: \$27.96... http://www.amazon.com/exec/obidos/ASIN/0375756248/qid=981919875/s... (amazon)	<input type="checkbox"/>
I) 9) Gmat 2000-2001 (Gmat Cat (Kaplan)(Book & Cd-Rom)) Usually ships in 24 hours (Paperback - March 2000) Amazon Price: \$29.60... http://www.amazon.com/exec/obidos/ASIN/0684870088/qid=981919875/s... (amazon)	<input type="checkbox"/>
I) 10) Textbook of Veterinary Internal Medicine: Diseases of the Dog and Cat (2-Volume Set) Usually ships in 24 hours by Stephen J. Ettinger(Editor), Edward C. Feldman(Editor)(Hardcover) Amazon Price: \$195.00... http://www.amazon.com/exec/obidos/ASIN/0721672568/qid=981919875/s... (amazon)	<input type="checkbox"/>

Search Engine 2: borders2
Query2: Cat

I) 1) Abyssinian Cats: Everything about Acquisition, Care, Nutrition, Behaviour, Health Care, & Breeding

Flowers for your Valentine ita.com
 NOW easy ordering at
N Netscape Netcenter
 Click Here...

netMarket Auction
VCR Spectacular
 Bids start at **\$1**
 Click Now!

February 6, 1998
 NEWS ABC NEWS Headlines

U.S. Presence Growing in Iraq

In stock - ships in 24 hours
 Hauppauge, J. Anne ~ Trade Paperback ~ 1995
 Borders Price: \$5.26 ~ You Save: \$0.69 (10%)...
<http://search.borders.com/cgi-bin/db2www/search/search.d2w/Detal...> (borders)

I) 2) Animal Clinic for Cats
 In stock - ships in 24 hours
 Humphries, Jim ~ Hardcover ~ 1998
 Borders Price: \$5.39 ~ You Save: \$1.60 (20%)...
<http://search.borders.com/cgi-bin/db2www/search/search.d2w/Detal...> (borders)

I) 3) Adopting Cats & Kittens: A Care & Training Guide
 Ships within 2-3 days
 Jankowski, Connie ~ Trade Paperback ~ 1993
 Borders Price: \$7.20 ~ You Save: \$0.80 (10%)...
<http://search.borders.com/cgi-bin/db2www/search/search.d2w/Detal...> (borders)

I) 4) Bedtime Stories for Cats
 In stock - ships in 24 hours
 Jasheway, Leigh A. ~ Hardcover ~ 1997
 Borders Price: \$7.96 ~ You Save: \$1.99 (20%)...
<http://search.borders.com/cgi-bin/db2www/search/search.d2w/Detal...> (borders)

I) 5) 250 Things You Can Do to Make Your Cat Adore You
 In stock - ships in 24 hours
 Newkirk, Ingrid ~ Trade Paperback ~ 1998
 Borders Price: \$9.90 ~ You Save: \$1.10 (10%)...
<http://search.borders.com/cgi-bin/db2www/search/search.d2w/Detal...> (borders)

I) 6) Aloha, Dolores
 In stock - ships in 24 hours
 Samuels, Barbara ~ Hardcover ~ 2000
 Borders Price: \$12.76 ~ You Save: \$3.19 (20%)...
<http://search.borders.com/cgi-bin/db2www/search/search.d2w/Detal...> (borders)

I) 7) Alfie & the Birthday Surprise
 In stock - ships in 24 hours
 Hughes, Shirley ~ Hardcover ~ 1998
 Borders Price: \$12.80 ~ You Save: \$3.20 (20%)...
<http://search.borders.com/cgi-bin/db2www/search/search.d2w/Detal...> (borders)

I) 8) All about Himalayan Cats
 In stock - ships in 24 hours
 Bearley, Joan M. ~ Hardcover ~ 1989
 Borders Price: \$14.36 ~ You Save: \$3.59 (20%)...
<http://search.borders.com/cgi-bin/db2www/search/search.d2w/Detal...> (borders)

I) 9) Arthur's World of Cats
 In stock - ships in 24 hours
 Head, Ann ~ Hardcover ~ 1997
 Borders Price: \$18.36 ~ You Save: \$4.59 (20%)...
<http://search.borders.com/cgi-bin/db2www/search/search.d2w/Detal...> (borders)

I) 10) Accreditation of Teacher Education: The Story of CATE 1984-1989
 In stock - ships in 24 hours
 MacIntyre, Gordon ~ Trade Paperback ~ 1991
 Borders Price: \$34.95 ...
<http://search.borders.com/cgi-bin/db2www/search/search.d2w/Detal...> (borders)

Search Engine 3: [barnesandnoble3](http://barnesandnoble.com)
 Query3: Cat

I) 1) Cat's Letters to Santa
 In Stock: 24 hours (Same Day).
 Bill Adler (Editor), Paul Bacon (Illustrator) / Hardcover / Galahad Books / September 1997
 B&N Price: \$2.99 ~ You Save 50%...
<http://shop.barnesandnoble.com/booksearch/isbnInquiry.asp?userid=...> (barnesandnoble)

I) 2) 2001 Hello Kitty Wall Calendar
 In Stock: 24 hours.
 Cal 2001* (Illustrator) / Wall Calendar / Abrams, Harry N Inc / June 2000
 B&N Price: \$4.97 ~ You Save 50%...
<http://shop.barnesandnoble.com/booksearch/isbnInquiry.asp?userid=...> (barnesandnoble)

I) 3) 2001 Original 365 Cats Page-A-Day Calendar
 In Stock: 24 hours.
 Cal 2001 / Box Calendar / Workman Publishing Company, Inc. / June 2000
 B&N Price: \$5.47 ~ You Save 50%...
<http://shop.barnesandnoble.com/booksearch/isbnInquiry.asp?userid=...> (barnesandnoble)

I) 4) 2001 Classic Cats Wall Calendar
 In Stock: 24 hours.
 Cal 2001 / Wall Calendar / June 2000
 B&N Price: \$5.97 ~ You Save 50%...
<http://shop.barnesandnoble.com/booksearch/isbnInquiry.asp?userid=...> (barnesandnoble)

I) 5) The Cat Who Robbed a Bank
 In Stock: 24 hours (Same Day).
 Lillian Jackson Braun / Paperback / Berkley Publishing Group / January 2001
 B&N Price: \$6.29 ~ You Save 10%...
<http://shop.barnesandnoble.com/booksearch/isbnInquiry.asp?userid=...> (barnesandnoble)

I) 6) The Cat in the Hat (Classic Gift Seuss Series)
 In Stock: 24 hours (Same Day).
 Dr. Seuss / Hardcover / Random House, Incorporated / May 1976
 B&N Price: \$6.39 ~ You Save 20%...
<http://shop.barnesandnoble.com/booksearch/isbnInquiry.asp?userid=...> (barnesandnoble)

I) 7) How to Live with a Neurotic Cat
 In Stock: 24 hours (Same Day).
 Stephen Baker / Hardcover / Random House Value Publishing, Incorporated / September 1999
 B&N Price: \$7.99...
<http://shop.barnesandnoble.com/booksearch/isbnInquiry.asp?userid=...> (barnesandnoble)

I) 8) The Cat Who Smelled a Rat

In Stock: 24 hours (Same Day).
 Lilian Jackson Braun / Hardcover / Penguin Putnam / January 2001
 B&N Price: \$19.16 ~ You Save 20%...
<http://shop.barnesandnoble.com/booksearch/isbnInquiry.asp?userid=...> (barnesandnoble)

I) 9) Cracking the GRE CAT with CD-ROM, 2001 Edition
 In Stock: 24 hours (Same Day).
 Karen Lurie / Paperback / Princeton Review Publishing Corporation / June 2000
 B&N Price: \$24.80 ~ You Save 20%...
<http://shop.barnesandnoble.com/booksearch/isbnInquiry.asp?userid=...> (barnesandnoble)

I) 10) Cracking the GMAT CAT with CD-ROM, 2001 Edition
 In-Stock: Ships 2-3 days.
 Geoff Martz / Paperback / Princeton Review Publishing Corporation / June 2000
 B&N Price: \$27.96 ~ You Save 20%...
<http://shop.barnesandnoble.com/booksearch/isbnInquiry.asp?userid=...> (barnesandnoble)

Search Engine 4: amazon4
Query4: Mouse

I) 1) Mouse Count
 Usually ships in 24 hours
 by Ellen Stoll Walsh(Paperback - March 1995)
 Amazon Price: \$4.95...
<http://www.amazon.com/exec/obidos/ASIN/0152002235/qid=981919875/s...> (amazon)

I) 2) Ben and Me : A New and Astonishing Life of Benjamin Franklin As Written by His Good Mouse Amos
 Usually ships in 24 hours
 by Robert Lawson(Illustrator)(Paperback - April 1988)
 Amazon Price: \$5.35...
<http://www.amazon.com/exec/obidos/ASIN/0316517305/qid=981919875/s...> (amazon)

I) 3) Cat & Mouse
 Usually ships in 24 hours
 by James Patterson(Mass Market Paperback - October 2000)
 Amazon Price: \$7.19...
<http://www.amazon.com/exec/obidos/ASIN/0446606189/qid=981919875/s...> (amazon)

I) 4) Mouse Count
 Usually ships in 1-2 weeks
 by Ellen Stoll Walsh, Diane D'Andrade(Editor)(School & Library Binding - March 1991)
 Amazon Price: \$10.40...
<http://www.amazon.com/exec/obidos/ASIN/0152560238/qid=981919875/s...> (amazon)

I) 5) The Mouse of Amherst
 Usually ships in 24 hours
 by Elizabeth Spires, Claire A. Nivola(Illustrator)(Hardcover - March 1999)
 Amazon Price: \$12.00...
<http://www.amazon.com/exec/obidos/ASIN/0374350833/qid=981919875/s...> (amazon)

I) 6) If You Give a Mouse a Cookie
 Usually ships in 24 hours
 by Felicia Bond(Illustrator), Laura Joffe Numeroff(Hardcover - May 1985)
 Amazon Price: \$12.76...
<http://www.amazon.com/exec/obidos/ASIN/0060245687/qid=981919875/s...> (amazon)

I) 7) If You Take a Mouse to the Movies
 Usually ships in 24 hours
 by Felicia Bond(Illustrator), Laura Joffe Numeroff(Hardcover - October 2000)
 Amazon Price: \$12.76...
<http://www.amazon.com/exec/obidos/ASIN/0060278676/qid=981919875/s...> (amazon)

I) 8) What's Wrong with My Mouse?: Behavioral Phenotyping of Transgenic and Knockout Mice
 Usually ships in 24 hours
 by Jacqueline N., Phd Crawley(Hardcover)
 Amazon Price: \$79.95...
<http://www.amazon.com/exec/obidos/ASIN/0471316393/qid=981919875/s...> (amazon)

I) 9) The Anatomical Basis of Mouse Development
 Usually ships in 24 hours
 by Matthew H. Kaufman, Jonathan B. L. Bard(Hardcover - March 1999)
 Amazon Price: \$99.95...
<http://www.amazon.com/exec/obidos/ASIN/0124020607/qid=981919875/s...> (amazon)

I) 10) The Atlas of the Mouse Development
 Usually ships in 24 hours
 by Matthew H. Kaufman(Hardcover - October 1997)
 Amazon Price: \$225.00...
<http://www.amazon.com/exec/obidos/ASIN/0124020356/qid=981919875/s...> (amazon)

Search Engine 5: amazon5
Query5: Dog

I) 1) Stone Fox (Harper Trophy Book)
 Usually ships in 24 hours
 by John Reynolds Gardiner, Marcia Sewall(Illustrator)(Paperback - February 1988)
 Amazon Price: \$4.45...
<http://www.amazon.com/exec/obidos/ASIN/0064401324/qid=981919875/s...> (amazon)

I) 2) How to Housebreak Your Dog in 7 Days
 Usually ships in 24 hours
 by Shirlee Kalstone(Paperback - April 1991)
 Amazon Price: \$6.29...
<http://www.amazon.com/exec/obidos/ASIN/0553346156/qid=981919875/s...> (amazon)

I) 3) Dog Heaven
 Usually ships in 24 hours
 by Cynthia Rylant(Illustrator)(School & Library Binding - September 1995)
 Amazon Price: \$12.76...
<http://www.amazon.com/exec/obidos/ASIN/0590417010/qid=981919875/s...> (amazon)

I) 4) The Stray Dog
 Usually ships in 24 hours
 by Marc Simont(Illustrator), Reiko Sassa(Hardcover - January 2001)
 Amazon Price: \$12.76...

<http://www.amazon.com/exec/obidos/ASIN/0060289333/qid=981919875/s...> (amazon)

I) 5) Let the Big Dog Eat : A Dictionary of the Secret Language of Golf

Usually ships in 24 hours
by Hubert Pedrol, et al(Hardcover - June 2000)
Amazon Price: \$14.40...
<http://www.amazon.com/exec/obidos/ASIN/0688175787/qid=981919875/s...> (amazon)

I) 6) Dog Training for Dummies (For Dummies)

Usually ships in 24 hours
by John Volhard, et al(Paperback - January 2001)
Amazon Price: \$17.59...
<http://www.amazon.com/exec/obidos/ASIN/0764552864/qid=981919875/s...> (amazon)

I) 7) How to Be Your Dog's Best Friend : A Training Manual for Dog Owners

Usually ships in 24 hours
by New Skete Monks, et al(Hardcover - October 1978)
Amazon Price: \$19.16...
<http://www.amazon.com/exec/obidos/ASIN/0316604917/qid=981919875/s...> (amazon)

I) 8) Going for the Blue: Inside the World of Show Dogs and Dog Shows

Usually ships in 24 hours
by Roger A. Caras(Hardcover - February 2001)
Amazon Price: \$20.76...
<http://www.amazon.com/exec/obidos/ASIN/0446526444/qid=981919875/s...> (amazon)

I) 9) Family Dog : 16 Weeks to a Well-Mannered Dog-A Simple and Time-Proven Method

Usually ships in 24 hours
by Richard A. Wolters, Red Smith(Introduction)(Hardcover - February 1999)
Amazon Price: \$22.36...
<http://www.amazon.com/exec/obidos/ASIN/0525944729/qid=981919875/s...> (amazon)

I) 10) The Dog Owners Home Veterinary Handbook

Usually ships in 2-3 days
by James M. Giffin, et al(Hardcover - November 1999)
Amazon Price: \$22.36...
<http://www.amazon.com/exec/obidos/ASIN/0876052014/qid=981919875/s...> (amazon)

Search Engine 6: [barnesandnoble6](#)

Query6: Dog

I) 1) Clifford's First Valentine's Day

In-Stock: Ships 2-3 days.
Norman Bridwell / Paperback / Scholastic, Inc. / November 1996
B&N Price: \$2.69 ~ You Save 10%...
<http://shop.barnesandnoble.com/booksearch/sbnInquiry.asp?userid=...> (barnesandnoble)

I) 2) Tigers at Twilight: (Magic Tree House Series #19)

In Stock: 24 hours (Same Day).
Mary Pope Osborne,Sal Murdocca (Illustrator) / Paperback / Random House Books for Young Readers / August 1999
B&N Price: \$3.59 ~ You Save 10%...
<http://shop.barnesandnoble.com/booksearch/sbnInquiry.asp?userid=...> (barnesandnoble)

I) 3) Clifford: The Big Red Dog

In Stock: 24 hours (Same Day).
Norman Bridwell / Board Book / Scholastic, Inc. / July 1997
B&N Price: \$4.79 ~ You Save 20%...
<http://shop.barnesandnoble.com/booksearch/sbnInquiry.asp?userid=...> (barnesandnoble)

I) 4) Where the Red Fern Grows

In Stock: 24 hours (Same Day).
Wilson Rawls / Mass Market Paperback / Bantam Books, Incorporated / May 1981
B&N Price: \$5.39 ~ You Save 10%...
<http://shop.barnesandnoble.com/booksearch/sbnInquiry.asp?userid=...> (barnesandnoble)

I) 5) Ginger Pye

In Stock: 24 hours (Same Day).
Eleanor Estes / Paperback / Harcourt / September 2000
B&N Price: \$5.40 ~ You Save 10%...
<http://shop.barnesandnoble.com/booksearch/sbnInquiry.asp?userid=...> (barnesandnoble)

I) 6) 2001 Original 365 Dogs Page-A-Day Calendar

In Stock: 24 hours.
Cal 2001 / Box Calendar / Workman Publishing Company, Inc. / August 2000
B&N Price: \$5.47 ~ You Save 50%...
<http://shop.barnesandnoble.com/booksearch/sbnInquiry.asp?userid=...> (barnesandnoble)

I) 7) 2001 William Wegman Puppies Wall Calendar

In Stock: 24 hours.
Cal 2001 / Wall Calendar / Abrams,Harry N Inc / June 2000
B&N Price: \$5.47 ~ You Save 50%...
<http://shop.barnesandnoble.com/booksearch/sbnInquiry.asp?userid=...> (barnesandnoble)

I) 8) 2001 Man's Best Friend Wall Calendar

In Stock: 24 hours.
Cal 2001,William Wegman (Photographer) / Wall Calendar / Abrams,Harry N Inc / June 2000
B&N Price: \$6.47 ~ You Save 50%...
<http://shop.barnesandnoble.com/booksearch/sbnInquiry.asp?userid=...> (barnesandnoble)

I) 9) How to Live with a Neurotic Dog

In Stock: 24 hours (Same Day).
Stephen Baker,Fred Hilliard (Illustrator) / Hardcover / Random House, Incorporated / February 1995
B&N Price: \$7.99...
<http://shop.barnesandnoble.com/booksearch/sbnInquiry.asp?userid=...> (barnesandnoble)

I) 10) Dog: The Complete Guide

In Stock: 24 hours (Same Day).
Sarah Whitehead / Hardcover / Barnes & Noble Books / August 1999
B&N Price: \$14.98...
<http://shop.barnesandnoble.com/booksearch/sbnInquiry.asp?userid=...> (barnesandnoble)

Search Engine 7: [barnesandnoble7](#)

Query7: Mouse

I) 1) Santa Mouse Coloring and Pencil Puzzle Book

In Stock: 24 hours (Same Day).
Michael Brown / Paperback / Barnes & Noble Books / July 1999
B&N Price: \$1.49 ~ You Save 50%...
<http://shop.barnesandnoble.com/booksearch/sbnInquiry.asp?userid=...> (barnesandnoble)

I) 2) Santa Mouse

In Stock: 24 hours (Same Day).
Michael Brown,Elfrieda DeWitt (Illustrator) / Hardcover / Barnes & Noble Books / August 1996
B&N Price: \$2.49 ~ You Save 50%...
<http://shop.barnesandnoble.com/booksearch/sbnInquiry.asp?userid=...> (barnesandnoble)

I) 3) Santa Mouse Where Are You

In Stock: 24 hours (Same Day).
Michael Brown,Elfrieda DeWitt (Illustrator) / Hardcover / Barnes & Noble Books / August 1997
B&N Price: \$2.49 ~ You Save 50%...
<http://shop.barnesandnoble.com/booksearch/sbnInquiry.asp?userid=...> (barnesandnoble)

I) 4) Disney's Toy Story: Movie Storybook

In Stock: 24 hours (Same Day).
Mouse Works Staff / Hardcover / Disney Enterprises, Incorporated / May 2000
B&N Price: \$3.98 ~ You Save 42%...
<http://shop.barnesandnoble.com/booksearch/sbnInquiry.asp?userid=...> (barnesandnoble)

I) 5) The Mouse and the Motorcycle

In Stock: 24 hours (Same Day).
Beverly Cleary,Louis Darling (Illustrator) / Paperback / Morrow,William & Co / August 1990
B&N Price: \$4.45 ~ You Save 10%...
<http://shop.barnesandnoble.com/booksearch/sbnInquiry.asp?userid=...> (barnesandnoble)

I) 6) Cat & Mouse

In Stock: 24 hours (Same Day).
James Patterson / Mass Market Paperback / Warner Books, Incorporated / October 1998
B&N Price: \$7.19 ~ You Save 10%...
<http://shop.barnesandnoble.com/booksearch/sbnInquiry.asp?userid=...> (barnesandnoble)

I) 7) If You Give a Mouse a Cookie Mini Book and Ornament

In Stock: 24 hours.
Laura Joffe Numeroff,Felicia Bond (Illustrator) / Hardcover / HarperCollins Children's Books / September 2000
B&N Price: \$7.96 ~ You Save 20%...
<http://shop.barnesandnoble.com/booksearch/sbnInquiry.asp?userid=...> (barnesandnoble)

I) 8) If You Give a Mouse a Cookie

In Stock: 24 hours (Same Day).
Laura Joffe Numeroff,Felicia Bond (Illustrator) / Hardcover / HarperCollins Children's Books / January 1985
B&N Price: \$11.96 ~ You Save 20%...
<http://shop.barnesandnoble.com/booksearch/sbnInquiry.asp?userid=...> (barnesandnoble)

I) 9) If You Take a Mouse to the Movies

In Stock: 24 hours.
Laura Joffe Numeroff,Felicia Bond (Illustrator) / Hardcover / HarperCollins Children's Books / September 2000
B&N Price: \$12.76 ~ You Save 20%...
<http://shop.barnesandnoble.com/booksearch/sbnInquiry.asp?userid=...> (barnesandnoble)

I) 10) Craft Lessons: Teaching Writing K through 8

In Stock: 24 hours.
Ralph J. Fletcher,Joann Portalupi / Paperback / Stenhouse Publishers / September 1998
B&N Price: \$17.50...
<http://shop.barnesandnoble.com/booksearch/sbnInquiry.asp?userid=...> (barnesandnoble)

Search Engine 8: borders8

Query8: Dog

I) 1) Baby Animals: Puppies

In stock - ships in 24 hours
Petty, Kate ~ Trade Paperback ~ 1992
Borders Price: \$3.56 ~ You Save: \$0.39 (10%)...
<http://search.borders.com/cgi-bin/db2www/search/search.d2w/Detail...> (borders)

I) 2) Animal Clinic for Dogs

In stock - ships in 24 hours
Humphries, Jim ~ Hardcover ~ 1998
Borders Price: \$6.39 ~ You Save: \$1.60 (20%)...
<http://search.borders.com/cgi-bin/db2www/search/search.d2w/Detail...> (borders)

I) 3) Adopting the Racing Greyhound

In stock - ships in 24 hours
Branigan, Cynthia A. ~ Trade Paperback ~ 1998
Borders Price: \$11.66 ~ You Save: \$1.29 (10%)...
<http://search.borders.com/cgi-bin/db2www/search/search.d2w/Detail...> (borders)

I) 4) Bark Busters: Solving Your Dog's Behavioral Problems

In stock - ships in 24 hours
Wilson, Sylvia ~ Trade Paperback ~ 1997
Borders Price: \$11.66 ~ You Save: \$1.29 (10%)...
<http://search.borders.com/cgi-bin/db2www/search/search.d2w/Detail...> (borders)

I) 5) Anastasia, Absolutely

In stock - ships in 24 hours
Lowry, Lois ~ Hardcover ~ 1995
Borders Price: \$12.80 ~ You Save: \$3.20 (20%)...
<http://search.borders.com/cgi-bin/db2www/search/search.d2w/Detail...> (borders)

I) 6) Baby's Memory Book: A Baby Record Book

In stock - ships in 24 hours
Nister, Ernest ~ Hardcover ~ 1986
Borders Price: \$15.99 ~ You Save: \$4.00 (20%)...
<http://search.borders.com/cgi-bin/db2www/search/search.d2w/Detail...> (borders)

I) 7) A-Z of Dog Diseases & Health Problems

In stock - ships in 24 hours
Lane, Dick ~ Trade Paperback ~ 1997
Borders Price: \$22.46 ~ You Save: \$2.49 (10%)...
<http://search.borders.com/cgi-bin/db2www/search/search.d2w/Detail...> (borders)

I) 8) American Staffordshire Terrier: Gamester & Guardian

In stock - ships in 24 hours
Foster, Sarah ~ Trade Paperback ~ 1998
Borders Price: \$22.46 ~ You Save: \$2.49 (10%)...
<http://search.borders.com/cgi-bin/db2www/search/search.d2w/Detail...> (borders)

I) 9) Agility Training: The Fun Sport for All Dogs

In stock - ships in 24 hours
Simmons-Moake, Jane ~ Trade Paperback ~ 1992
Borders Price: \$23.35 ~ You Save: \$2.59 (10%)...
<http://search.borders.com/cgi-bin/db2www/search/search.d2w/Detail...> (borders)

I) 10) Advanced Gundog Training: Practical Fieldwork & Competition

In stock - ships in 24 hours
Deeley, Martin ~ Hardcover ~ 1994
Borders Price: \$27.95 ~ You Save: \$6.99 (20%)...
<http://search.borders.com/cgi-bin/db2www/search/search.d2w/Detail...> (borders)

Search Engine 9: google9

Query9: Cat

I) 1) Alley Cat Allies

Alley Cat Allies Has a Better Idea. Modelled after successful programs in the United Kingdom and parts of Africa and Europe, Alley Cat Allies (ACA) advocates a ...
<http://www.alleycat.org/> (google)

I) 2) Arctic Cat > What Drives You to the Great Outdoors?

Arctic Cat. Snowmobile ATV Watercraft Generators Catalogs. What's new on the site? Click ...
<http://www.arctic-cat.com/> (google)

I) 3) Beware of Cat! HUGE Cat Graphics Collection & Virtual Cat ...

Cat Postcards! Send an electronic Cat Postcard Now! Hundreds of cute cat cards to choose from! Holidays, Kittens, Cartoons, Love & More! Add Music, Backgrounds ...
<http://www.geocities.com/Heartland/Meadows/6485/> (google)

I) 4) Cat-Scan.Com - The Cover Page

Welcome to CliffyB's Cat-Scan! Cat-Scan is home to people who love art as much as their cats. So much so, they combine the two! Every weekday we'll bring you ...
<http://www.cat-scan.com/> (google)

I) 5) Cat Fanciers Web Site

Welcome to the Cat Fanciers Web Site! We offer General Information about Cats and Cat Care, Cat Breed Descriptions from Abyssinian to Turkish Van, ...
<http://www.fanciers.com/> (google)

I) 6) Cat Fancy

or killed playing with toy mice distributed in packages of Fresh Step cat litter, Clorox Co., Oakland, Calif., warned pet owners the toys could strangle or cut ...
<http://www.animalnetwork.com/cats/default.asp> (google)

I) 7) Cat Tales Zoological Park

LATEST UPDATE: October 20, 2000. Cat Tales Zoological Park. Do you have what it takes to become a zookeeper? Cat Tales Zoological Training Center. ...
<http://www.cattales.org/> (google)

I) 8) Feral Cat Coalition

Feral Cat Coalition, San Diego, California. Please follow these links for more information on the subject: Feral Cat Coalition Documents. ...
<http://www.feralcat.com/> (google)

I) 9) The Cat Fanciers' Association (CFA)

Welcome to the Cat Fanciers' Association, the world's largest registry of pedigreed cats! ...
<http://www.cfainc.org/> (google)

I) 10) TICA Website

WELCOME TO THE WEB SITE OF THE INTERNATIONAL CAT ASSOCIATION To Navigate the Site Frames No Frames Please See this page as a Shockwave movie. ...
<http://www.tica.org/> (google)

[Preview Order](#)

[Look4there](#)
 [News](#)
 [Weather](#)
 [Cool Sites](#)
 [Shopping](#)
[Div. of Internet Corporation](#)
 [Contests](#)
 [Horoscopes](#)
 [Classified](#)
[Visit Look4there2](#)

Phone: 1-631-757-1600 • E-Mail: look4there@look4there.com • Internet Corporation.

Current Group: I

amazon1	borders2	barnesandnoble3	amazon4	amazon5	barnesandnoble6	barnesandnoble7	borders8	google9
Cat	Cat	Cat	Mouse	Dog	Dog	Mouse	Dog	Cat

Go to page: [1](#) [2](#) [3](#) [4](#) [5](#) [6](#) [7](#) [8](#) [9](#)

Search Display (Interleaved or separately by search engine):
[Interleave](#)
[Combine \\$\[a-z\]](#)
[Combine \\$\[z-a\]](#)
[Separate](#)
[Separate \\$\[a-z\]](#)
[Separate \\$\[z-a\]](#)

Description or List (Site descriptions or lists): [\[List\]](#)



Look4itHere

- Discovery**
[Disney](#), [Warner](#), [ABC](#),
[Universal](#), [CBS](#), [NBC](#)
- Hot Wired**
[E!Online](#), [Riddler](#)
- TV Guide**
[Reel.com](#), [MusicBlvd](#),
[RealAudio](#), [AudioNet](#)
- BuyerSellers**
[Ebay](#), [DrugStore](#),
[ShopNow](#), [Vitamin](#)
- CIA Kids**
[eToys](#), [KBkids](#), [Pets](#),
[ToysRus](#), [PetSmart](#)
- Family**
[BlueMount](#), [Women](#),
[Village](#), [Epicurious](#)
- Weather**
[Intellicast](#), [MapQuest](#)
- CitySearch**
[555-1212](#), [Travelocity](#),
[Fodor's](#), [LeisurePlan](#)
- ESPN**
[SportsLine](#), [NFL](#), [NBA](#),
[SmallWorld](#), [NHL](#)
- CNN**
[NYTimes](#), [WSJournal](#),
[USAtoday](#), [ABCnews](#)
- StockMaster**
[CNNfn](#), [Bloomberg](#),
[DowJones](#), [Quote](#)
- CNet**
[ZDNet](#), [CMPnet](#), [IDG](#),
[Outpost](#), [Jumbo](#)
- Monster Board**
[JobBank](#), [BestJobs](#),
[Career](#), [Incpad](#), [Intl](#)

Search'em All: Search your favorite search engines, all at the same time*

Search 1: <input type="text" value="Cat"/>	<input type="text" value="Amazon.com"/>
Search 2: <input type="text" value="Cat"/>	<input type="text" value="Borders.com"/>
Search 3: <input type="text" value="Cat"/>	<input type="text" value="BarnesandNoble.com"/>
Search 4: <input type="text" value="Mouse"/>	<input type="text" value="Amazon.com"/>
Search 5: <input type="text" value="Dog"/>	<input type="text" value="Amazon.com"/>
Search 6: <input type="text" value="Dog"/>	<input type="text" value="BarnesandNoble.com"/>
Search 7: <input type="text" value="Mouse"/>	<input type="text" value="BarnesandNoble.com"/>
Search 8: <input type="text" value="Dog"/>	<input type="text" value="Borders.com"/>
Search 9: <input type="text" value="Cat"/>	<input type="text" value="Google"/>

Search Engine Results: URL's per Search Engine:

URL Details: Timeout (seconds) per Search Engine:

Page: Searches per Group: Group: * Only 1 entry required

Search'em All: multiple simultaneous same* or different searches

<ul style="list-style-type: none"> Autos Buy, Cars, Racing Business Investments, Funds, Companies, Industry Careers Jobs, Universities, Education Entertainment Movies, Music, TV, Games, Chat 	<ul style="list-style-type: none"> Fashion Designers, Style, Models Health Drugs, Diseases, News Homes Food, Wine, Gardening Issues Government, Politics, Taxes, Editorials People Relationships, Dating, Psychology 	<ul style="list-style-type: none"> Society Philosophy, Economics, Religion, Sociology Sports Baseball, Basketball, Football, Hockey Technology Computers, Environment, Engineering, Internet Travel Maps, Vacations, Fares
--	--	--

Flowers for your Valentine
[itcd.com](#)

NOW easy ordering at
N Netscape Netcenter
[Click Here...](#)

netMarket Auction
VCR Spectacular

Bids start at **1**

[Click Now!](#)

February 6, 1998
NEWS ABC NEWS Headlines

U.S. Presence Growing In Iraq

Look4itHere
Div. of Internet Corporation

News	Weather	Cool Sites	Shopping
Contests	Horoscopes	Classified	

Phone: 1-631-757-1600 · E-Mail: look4itHere@look4itHere.com · Internet Corporation.

FIG. 59

FIG. 60

Look4itHere

Discovery
[Disney, Warner, ABC, Universal, CBS, NBC](#)

Hot Wired
[E!Online, Riddler](#)

TV Guide
[Reel.com, MusicBivd, RealAudio, AudioNet](#)

BuyerSellers
[Ebay, DrugStore, ShopNow, Vitamin](#)

CIA Kids
[eToys, KBklds, Pets, ToysRus, PetSmart](#)

Family
[BlueMount, Women, Village, Epicurious](#)

Weather
[Intellicast, MapQuest](#)

CitySearch
[555-1212, Travelocity, Fodor's, LeisurePlan](#)

ESPN
[SportsLine, NFL, NBA, SmallWorld, NHL](#)

CNN
[NYTimes, WSJournal, USAtoday, ABCnews](#)

StockMaster
[CNNIn, Bloomberg, DowJones, Quote](#)

CNet
[ZDNet, CMPnet, IDC, Outpost, Jumbo](#)

Monster Board
[JobBank, BestJobs, Career, Inccpad, Intl](#)

Search'em All: Search your favorite search engines, all at the same time!

Search 1: WebCrawler

Search 2: Altavista

Search 3: Lycos

Search 4: Google

Search 5: Excite

Search 6: Yahoo

Search 7: LookSmart

Search 8: HotBot

Search 9: Dejanews

Search Engine Results: URL's per Search Engine:

URL Details: Timeout (seconds) per Search Engine:

Page: Searches per Group: Group: Only 1 entry required

Search Engine Report

Search Engine 1: [amazon1](#)
 Query1: [Cat](#)

I) 1) Textbook of Veterinary Internal Medicine: Diseases of the Dog and Cat (2-Volume Set)
 Usually ships in 24 hours
 by Stephen J. Ettinger(Editor), Edward C. Feldman(Editor)(Hardcover)
 Amazon Price: \$195.00...
<http://www.amazon.com/exec/obidos/ASIN/0721672566/qid=981919922/s...> (amazon)

I) 2) Gmat 2000-2001 (Gmat Cat (Kaplan)(Book & Cd-Rom))
 Usually ships in 24 hours
 (Paperback - March 2000)
 Amazon Price: \$29.60...
<http://www.amazon.com/exec/obidos/ASIN/0684870088/qid=981919922/s...> (amazon)

I) 3) Cracking the Gmat 2001 (Cracking the Gmat Cat With Sample Tests on Cd-Rom)
 Usually ships in 24 hours
 by Martz, Geoff Martz(Paperback - June 2000)
 Amazon Price: \$27.96...
<http://www.amazon.com/exec/obidos/ASIN/0375756248/qid=981919922/s...> (amazon)

I) 4) The Cat Who Smelled a Rat
 Usually ships in 24 hours
 by Lillian Jackson Braun(Hardcover - January 2001)
 Amazon Price: \$19.16...
<http://www.amazon.com/exec/obidos/ASIN/0399146652/qid=981919922/s...> (amazon)

I) 5) The Cat Who Covered the World : The Adventures of Henrietta and Her Foreign Correspondent
 Usually ships in 24 hours
 by Christopher S. Wren(Hardcover - November 2000)
 Amazon Price: \$16.80...
<http://www.amazon.com/exec/obidos/ASIN/0694871009/qid=981919922/s...> (amazon)

I) 6) The Cat Who Smelled a Rat (ABRIDGED)
 Usually ships in 24 hours
 by Lillian Jackson Braun(Audio Cassette - January 2001)
 Amazon Price: \$16.15...
<http://www.amazon.com/exec/obidos/ASIN/0399146814/qid=981919922/s...> (amazon)

I) 7) Cat Heaven
 Usually ships in 24 hours
 by Cynthia Rylant(Illustrator)(School & Library Binding - September 1997)
 Amazon Price: \$12.76...
<http://www.amazon.com/exec/obidos/ASIN/0590100548/qid=981919922/s...> (amazon)

I) 8) Master the Gre Cat 2001 (Master the Gre, 2001)
 Usually ships in 2-3 days
 by Thomas H. Martinson(Paperback - November 2000)
 Amazon Price: \$11.16...
<http://www.amazon.com/exec/obidos/ASIN/0764561197/qid=981919922/s...> (amazon)

I) 9) Eating the Cheshire Cat
 Usually ships in 24 hours
 by Helen Ellis(Paperback - February 2001)
 Amazon Price: \$10.40...
<http://www.amazon.com/exec/obidos/ASIN/069486441X/qid=981919922/s...> (amazon)

I) 10) Pawing Through the Past (Age of Unreason)
 Usually ships in 24 hours
 by Rita Mae Brown, Sneaky Pie Brown(Mass Market Paperback - January 2001)
 Amazon Price: \$6.29...
<http://www.amazon.com/exec/obidos/ASIN/0553580256/qid=981919922/s...> (amazon)

Search Engine 2: [borders2](#)
 Query2: [Cat](#)

I) 1) Accreditation of Teacher Education: The Story of CATE 1984-1989

Order Quantity Below

U.S. Presence Growing in Iraq

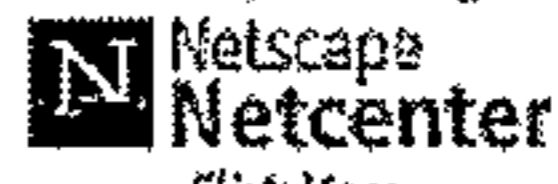
Flowers for your Valentine
[itd.com](#)
 NOW easy ordering at

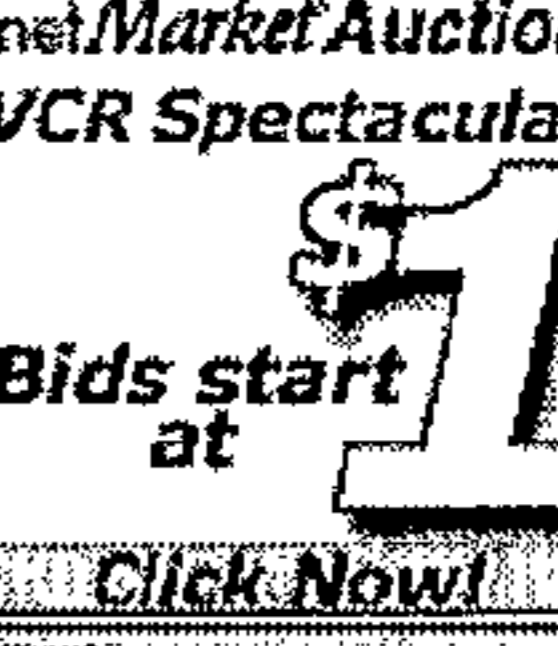
[Click Here...](#)

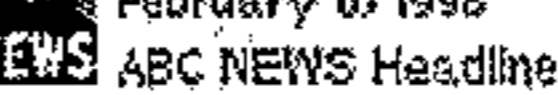
netMarket Auction VCR Spectacular

Bids start at 1
[Click Now!](#)

February 6, 1998
 ABC NEWS Headlines

In stock - ships in 24 hours
 MacIntyre, Gordon ~ Trade Paperback ~ 1991
 Borders Price: \$34.95 ...
<http://search.borders.com/cgi-bin/db2www/search/search.d2w/Detail...> (borders)

I) 2) Arthur's World of Cats
 In stock - ships in 24 hours
 Head, Ann ~ Hardcover ~ 1997
 Borders Price: \$18.36 ~ You Save: \$4.59 (20%)...
<http://search.borders.com/cgi-bin/db2www/search/search.d2w/Detail...> (borders)

I) 3) All about Himalayan Cats
 In stock - ships in 24 hours
 Bearley, Joan M. ~ Hardcover ~ 1989
 Borders Price: \$14.36 ~ You Save: \$3.59 (20%)...
<http://search.borders.com/cgi-bin/db2www/search/search.d2w/Detail...> (borders)

I) 4) Alfie & the Birthday Surprise
 In stock - ships in 24 hours
 Hughes, Shirley ~ Hardcover ~ 1998
 Borders Price: \$12.80 ~ You Save: \$3.20 (20%)...
<http://search.borders.com/cgi-bin/db2www/search/search.d2w/Detail...> (borders)

I) 5) Aloha, Dolores
 In stock - ships in 24 hours
 Samuels, Barbara ~ Hardcover ~ 2000
 Borders Price: \$12.76 ~ You Save: \$3.19 (20%)...
<http://search.borders.com/cgi-bin/db2www/search/search.d2w/Detail...> (borders)

I) 6) 250 Things You Can Do to Make Your Cat Adore You
 In stock - ships in 24 hours
 Newkirk, Ingrid ~ Trade Paperback ~ 1998
 Borders Price: \$9.90 ~ You Save: \$1.10 (10%)...
<http://search.borders.com/cgi-bin/db2www/search/search.d2w/Detail...> (borders)

I) 7) Bedtime Stories for Cats
 In stock - ships in 24 hours
 Jasheway, Leigh A. ~ Hardcover ~ 1997
 Borders Price: \$7.96 ~ You Save: \$1.99 (20%)...
<http://search.borders.com/cgi-bin/db2www/search/search.d2w/Detail...> (borders)

I) 8) Adopting Cats & Kittens: A Care & Training Guide
 Ships within 2-3 days
 Jankowski, Connie ~ Trade Paperback ~ 1993
 Borders Price: \$7.20 ~ You Save: \$0.80 (10%)...
<http://search.borders.com/cgi-bin/db2www/search/search.d2w/Detail...> (borders)

I) 9) Animal Clinic for Cats
 In stock - ships in 24 hours
 Humphries, Jim ~ Hardcover ~ 1998
 Borders Price: \$6.39 ~ You Save: \$1.60 (20%)...
<http://search.borders.com/cgi-bin/db2www/search/search.d2w/Detail...> (borders)

I) 10) Abyssinian Cats: Everything about Acquisition, Care, Nutrition, Behavior, Health Care, & Breeding
 In stock - ships in 24 hours
 Hauppauge, J. Anne ~ Trade Paperback ~ 1995
 Borders Price: \$6.26 ~ You Save: \$0.69 (10%)...
<http://search.borders.com/cgi-bin/db2www/search/search.d2w/Detail...> (borders)

Search Engine 3: barnesandnoble.com
 Query3: Cat

I) 1) Cracking the GMAT CAT with CD-ROM, 2001 Edition
 In-Stock: Ships 2-3 days.
 Geoff Martz / Paperback / Princeton Review Publishing Corporation / June 2000
 B&N Price: \$27.96 ~ You Save 20%...
<http://shop.barnesandnoble.com/booksearch/isbnInquiry.asp?userid=...> (barnesandnoble)

I) 2) Cracking the GRE CAT with CD-ROM, 2001 Edition
 In Stock: 24 hours (Same Day).
 Karen Lurie / Paperback / Princeton Review Publishing Corporation / June 2000
 B&N Price: \$24.80 ~ You Save 20%...
<http://shop.barnesandnoble.com/booksearch/isbnInquiry.asp?userid=...> (barnesandnoble)

I) 3) The Cat Who Smelled a Rat
 In Stock: 24 hours (Same Day).
 Lillian Jackson Braun / Hardcover / Penguin Putnam / January 2001
 B&N Price: \$19.16 ~ You Save 20%...
<http://shop.barnesandnoble.com/booksearch/isbnInquiry.asp?userid=...> (barnesandnoble)

I) 4) How to Live with a Neurotic Cat
 In Stock: 24 hours (Same Day).
 Stephen Baker / Hardcover / Random House Value Publishing, Incorporated / September 1999
 B&N Price: \$7.99...
<http://shop.barnesandnoble.com/booksearch/isbnInquiry.asp?userid=...> (barnesandnoble)

I) 5) The Cat in the Hat (Classic Gift Seuss Series)
 In Stock: 24 hours (Same Day).
 Dr. Seuss / Hardcover / Random House, Incorporated / May 1976
 B&N Price: \$6.39 ~ You Save 20%...
<http://shop.barnesandnoble.com/booksearch/isbnInquiry.asp?userid=...> (barnesandnoble)

I) 6) The Cat Who Robbed a Bank
 In Stock: 24 hours (Same Day).
 Lillian Jackson Braun / Paperback / Berkley Publishing Group / January 2001
 B&N Price: \$6.29 ~ You Save 10%...
<http://shop.barnesandnoble.com/booksearch/isbnInquiry.asp?userid=...> (barnesandnoble)

I) 7) 2001 Classic Cats Wall Calendar
 In Stock: 24 hours.
 Cal 2001 / Wall Calendar / June 2000
 B&N Price: \$5.97 ~ You Save 50%...
<http://shop.barnesandnoble.com/booksearch/isbnInquiry.asp?userid=...> (barnesandnoble)

I) 8) 2001 Original 365 Cats Page-A-Day Calendar

In Stock: 24 hours.
 Cal 2001 / Box Calendar / Workman Publishing Company, Inc. / June 2000
 B&N Price: \$5.47 ~ You Save 50%...
<http://shop.barnesandnoble.com/booksearch/sbnInquiry.asp?userid=...> (barnesandnoble)

I) 9) 2001 Hello Kitty Wall Calendar

In Stock: 24 hours.
 Cal 2001* (Illustrator) / Wall Calendar / Abrams,Harry N Inc / June 2000
 B&N Price: \$4.97 ~ You Save 50%...
<http://shop.barnesandnoble.com/booksearch/sbnInquiry.asp?userid=...> (barnesandnoble)

I) 10) Cat's Letters to Santa

In Stock: 24 hours (Same Day).
 Bill Adler (Editor), Paul Bacon (Illustrator) / Hardcover / Galahad Books / September 1997
 B&N Price: \$2.99 ~ You Save 50%...
<http://shop.barnesandnoble.com/booksearch/sbnInquiry.asp?userid=...> (barnesandnoble)

Search Engine 4: amazon4

Query4: Mouse

I) 1) The Atlas of the Mouse Development

Usually ships in 24 hours
 by Matthew H. Kaufman(Hardcover - October 1997)
 Amazon Price: \$225.00...
<http://www.amazon.com/exec/obidos/ASIN/0124020356/qid=981919922/s...> (amazon)

I) 2) The Anatomical Basis of Mouse Development

Usually ships in 24 hours
 by Matthew H. Kaufman, Jonathan B. L. Bard(Hardcover - March 1999)
 Amazon Price: \$99.95...
<http://www.amazon.com/exec/obidos/ASIN/0124020607/qid=981919922/s...> (amazon)

I) 3) What's Wrong with My Mouse?: Behavioral Phenotyping of Transgenic and Knockout Mice

Usually ships in 24 hours
 by Jacqueline N., Phd Crawley(Hardcover)
 Amazon Price: \$79.95...
<http://www.amazon.com/exec/obidos/ASIN/0471316393/qid=981919922/s...> (amazon)

I) 4) If You Take a Mouse to the Movies

Usually ships in 24 hours
 by Felicia Bond(Illustrator), Laura Joffe Numeroff(Hardcover - October 2000)
 Amazon Price: \$12.76...
<http://www.amazon.com/exec/obidos/ASIN/0060278676/qid=981919922/s...> (amazon)

I) 5) If You Give a Mouse a Cookie

Usually ships in 24 hours
 by Felicia Bond(Illustrator), Laura Joffe Numeroff(Hardcover - May 1985)
 Amazon Price: \$12.76...
<http://www.amazon.com/exec/obidos/ASIN/0060245867/qid=981919922/s...> (amazon)

I) 6) The Mouse of Amherst

Usually ships in 24 hours
 by Elizabeth Spires, Claire A. Nivola(Illustrator)(Hardcover - March 1999)
 Amazon Price: \$12.00...
<http://www.amazon.com/exec/obidos/ASIN/0374350833/qid=981919922/s...> (amazon)

I) 7) Mouse Count

Usually ships in 1-2 weeks
 by Ellen Stoll Walsh, Diane D'Andrade(Editor)(School & Library Binding - March 1991)
 Amazon Price: \$10.40...
<http://www.amazon.com/exec/obidos/ASIN/0152560238/qid=981919922/s...> (amazon)

I) 8) Cat & Mouse

Usually ships in 24 hours
 by James Patterson(Mass Market Paperback - October 2000)
 Amazon Price: \$7.19...
<http://www.amazon.com/exec/obidos/ASIN/0446606189/qid=981919922/s...> (amazon)

I) 9) Ben and Me : A New and Astonishing Life of Benjamin Franklin As Written by His Good Mouse Amos

Usually ships in 24 hours
 by Robert Lawson(Illustrator)(Paperback - April 1988)
 Amazon Price: \$5.35...
<http://www.amazon.com/exec/obidos/ASIN/0316517305/qid=981919922/s...> (amazon)

I) 10) Mouse Count

Usually ships in 24 hours
 by Ellen Stoll Walsh(Paperback - March 1995)
 Amazon Price: \$4.95...
<http://www.amazon.com/exec/obidos/ASIN/0152002235/qid=981919922/s...> (amazon)

Search Engine 5: amazon5

Query5: Dog

I) 1) The Dog Owners Home Veterinary Handbook

Usually ships in 2-3 days
 by James M. Giffin, et al(Hardcover - November 1999)
 Amazon Price: \$22.36...
<http://www.amazon.com/exec/obidos/ASIN/0876052014/qid=981919922/s...> (amazon)

I) 2) Family Dog : 16 Weeks to a Well-Mannered Dog-A Simple and Time-Proven Method

Usually ships in 24 hours
 by Richard A. Wolters, Red Smith(Introduction)(Hardcover - February 1999)
 Amazon Price: \$22.36...
<http://www.amazon.com/exec/obidos/ASIN/0525944729/qid=981919922/s...> (amazon)

I) 3) Going for the Blue: Inside the World of Show Dogs and Dog Shows

Usually ships in 24 hours
 by Roger A. Caras(Hardcover - February 2001)
 Amazon Price: \$20.76...
<http://www.amazon.com/exec/obidos/ASIN/0446526444/qid=981919922/s...> (amazon)

I) 4) How to Be Your Dog's Best Friend : A Training Manual for Dog Owners

Usually ships in 24 hours
 by New Skate Monks, et al(Hardcover - October 1978)
 Amazon Price: \$19.16...
<http://www.amazon.com/exec/obidos/ASIN/0316604917/qid=981919922/s...> (amazon)

I) 5) Dog Training for Dummies (For Dummies)
 Usually ships in 24 hours
 by John Volhard, et al(Paperback - January 2001)
 Amazon Price: \$17.59...
<http://www.amazon.com/exec/obidos/ASIN/0764552864/qid=981919922/s...> (amazon)

I) 6) Let the Big Dog Eat : A Dictionary of the Secret Language of Golf
 Usually ships in 24 hours
 by Hubert Pedrol, et al(Hardcover - June 2000)
 Amazon Price: \$14.40...
<http://www.amazon.com/exec/obidos/ASIN/0688175787/qid=981919922/s...> (amazon)

I) 7) The Stray Dog
 Usually ships in 24 hours
 by Marc Simon(illustrator), Reiko Sassa(Hardcover - January 2001)
 Amazon Price: \$12.76...
<http://www.amazon.com/exec/obidos/ASIN/0060289333/qid=981919922/s...> (amazon)

I) 8) Dog Heaven
 Usually ships in 24 hours
 by Cynthia Rylan(illustrator)(School & Library Binding - September 1995)
 Amazon Price: \$12.76...
<http://www.amazon.com/exec/obidos/ASIN/0590417010/qid=981919922/s...> (amazon)

I) 9) How to Housebreak Your Dog in 7 Days
 Usually ships in 24 hours
 by Shirlee Kalstone(Paperback - April 1991)
 Amazon Price: \$6.29...
<http://www.amazon.com/exec/obidos/ASIN/0553346156/qid=981919922/s...> (amazon)

I) 10) Stone Fox (Harper Trophy Book)
 Usually ships in 24 hours
 by John Reynolds Gardiner, Marcia Sewall(illustrator)(Paperback - February 1988)
 Amazon Price: \$4.45...
<http://www.amazon.com/exec/obidos/ASIN/0064401324/qid=981919922/s...> (amazon)

Search Engine 6: [barnesandnoble6](#)
 Query6: Dog

I) 1) Dog: The Complete Guide
 In Stock: 24 hours (Same Day).
 Sarah Whitehead / Hardcover / Barnes & Noble Books / August 1999
 B&N Price: \$14.99...
<http://shop.barnesandnoble.com/booksearch/isbnInquiry.asp?userid=...> (barnesandnoble)

I) 2) How to Live with a Neurotic Dog
 In Stock: 24 hours (Same Day).
 Stephen Baker, Fred Hilliard (illustrator) / Hardcover / Random House, Incorporated / February 1995
 B&N Price: \$7.99...
<http://shop.barnesandnoble.com/booksearch/isbnInquiry.asp?userid=...> (barnesandnoble)

I) 3) 2001 Man's Best Friend Wall Calendar
 In Stock: 24 hours.
 Cal 2001, William Wegman (Photographer) / Wall Calendar / Abrams, Harry N Inc / June 2000
 B&N Price: \$6.47 ~ You Save 50%...
<http://shop.barnesandnoble.com/booksearch/isbnInquiry.asp?userid=...> (barnesandnoble)

I) 4) 2001 William Wegman Puppies Wall Calendar
 In Stock: 24 hours.
 Cal 2001 / Wall Calendar / Abrams, Harry N Inc / June 2000
 B&N Price: \$5.47 ~ You Save 50%...
<http://shop.barnesandnoble.com/booksearch/isbnInquiry.asp?userid=...> (barnesandnoble)

I) 5) 2001 Original 365 Dogs Page-A-Day Calendar
 In Stock: 24 hours.
 Cal 2001 / Box Calendar / Workman Publishing Company, Inc. / August 2000
 B&N Price: \$5.47 ~ You Save 50%...
<http://shop.barnesandnoble.com/booksearch/isbnInquiry.asp?userid=...> (barnesandnoble)

I) 6) Ginger Pye
 In Stock: 24 hours (Same Day).
 Eleanor Estes / Paperback / Harcourt / September 2000
 B&N Price: \$5.40 ~ You Save 10%...
<http://shop.barnesandnoble.com/booksearch/isbnInquiry.asp?userid=...> (barnesandnoble)

I) 7) Where the Red Fern Grows
 In Stock: 24 hours (Same Day).
 Wilson Rawls / Mass Market Paperback / Bantam Books, Incorporated / May 1981
 B&N Price: \$5.39 ~ You Save 10%...
<http://shop.barnesandnoble.com/booksearch/isbnInquiry.asp?userid=...> (barnesandnoble)

I) 8) Clifford: The Big Red Dog
 In Stock: 24 hours (Same Day).
 Norman Bridwell / Board Book / Scholastic, Inc. / July 1997
 B&N Price: \$4.79 ~ You Save 20%...
<http://shop.barnesandnoble.com/booksearch/isbnInquiry.asp?userid=...> (barnesandnoble)

I) 9) Tigers at Twilight: (Magic Tree House Series #19)
 In Stock: 24 hours (Same Day).
 Mary Pope Osborne, Sal Murdocca (illustrator) / Paperback / Random House Books for Young Readers / August 1999
 B&N Price: \$3.59 ~ You Save 10%...
<http://shop.barnesandnoble.com/booksearch/isbnInquiry.asp?userid=...> (barnesandnoble)

I) 10) Clifford's First Valentine's Day
 In-Stock: Ships 2-3 days.
 Norman Bridwell / Paperback / Scholastic, Inc. / November 1996
 B&N Price: \$2.69 ~ You Save 10%...
<http://shop.barnesandnoble.com/booksearch/isbnInquiry.asp?userid=...> (barnesandnoble)

Search Engine 7: [barnesandnoble7](#)
 Query7: Mouse

I) 1) Craft Lessons: Teaching Writing K through 8

In Stock: 24 hours.
 Ralph J. Fletcher, Joann Portalupi / Paperback / Stenhouse Publishers / September 1998
 B&N Price: \$17.50...
<http://shop.barnesandnoble.com/booksearch/sbnInquiry.asp?userid=...> (barnesandnoble)

I) 2) If You Take a Mouse to the Movies

In Stock: 24 hours.
 Laura Joffe Numeroff, Felicia Bond (Illustrator) / Hardcover / HarperCollins Children's Books / September 2000
 B&N Price: \$12.76 ~ You Save 20%...
<http://shop.barnesandnoble.com/booksearch/sbnInquiry.asp?userid=...> (barnesandnoble)

I) 3) If You Give a Mouse a Cookie

In Stock: 24 hours (Same Day).
 Laura Joffe Numeroff, Felicia Bond (Illustrator) / Hardcover / HarperCollins Children's Books / January 1985
 B&N Price: \$11.96 ~ You Save 20%...
<http://shop.barnesandnoble.com/booksearch/sbnInquiry.asp?userid=...> (barnesandnoble)

I) 4) If You Give a Mouse a Cookie Mini Book and Ornament

In Stock: 24 hours.
 Laura Joffe Numeroff, Felicia Bond (Illustrator) / Hardcover / HarperCollins Children's Books / September 2000
 B&N Price: \$7.96 ~ You Save 20%...
<http://shop.barnesandnoble.com/booksearch/sbnInquiry.asp?userid=...> (barnesandnoble)

I) 5) Cat & Mouse

In Stock: 24 hours (Same Day).
 James Patterson / Mass Market Paperback / Warner Books, Incorporated / October 1998
 B&N Price: \$7.19 ~ You Save 10%...
<http://shop.barnesandnoble.com/booksearch/sbnInquiry.asp?userid=...> (barnesandnoble)

I) 6) The Mouse and the Motorcycle

In Stock: 24 hours (Same Day).
 Beverly Cleary, Louis Darling (Illustrator) / Paperback / Morrow, William & Co / August 1990
 B&N Price: \$4.45 ~ You Save 10%...
<http://shop.barnesandnoble.com/booksearch/sbnInquiry.asp?userid=...> (barnesandnoble)

I) 7) Disney's Toy Story: Movie Storybook

In Stock: 24 hours (Same Day).
 Mouse Works Staff / Hardcover / Disney Enterprises, Incorporated / May 2000
 B&N Price: \$3.98 ~ You Save 42%...
<http://shop.barnesandnoble.com/booksearch/sbnInquiry.asp?userid=...> (barnesandnoble)

I) 8) Santa Mouse Where Are You

In Stock: 24 hours (Same Day).
 Michael Brown, Elfrieda DeWitt (Illustrator) / Hardcover / Barnes & Noble Books / August 1997
 B&N Price: \$2.49 ~ You Save 50%...
<http://shop.barnesandnoble.com/booksearch/sbnInquiry.asp?userid=...> (barnesandnoble)

I) 9) Santa Mouse

In Stock: 24 hours (Same Day).
 Michael Brown, Elfrieda DeWitt (Illustrator) / Hardcover / Barnes & Noble Books / August 1996
 B&N Price: \$2.49 ~ You Save 50%...
<http://shop.barnesandnoble.com/booksearch/sbnInquiry.asp?userid=...> (barnesandnoble)

I) 10) Santa Mouse Coloring and Pencil Puzzle Book

In Stock: 24 hours (Same Day).
 Michael Brown / Paperback / Barnes & Noble Books / July 1999
 B&N Price: \$1.49 ~ You Save 50%...
<http://shop.barnesandnoble.com/booksearch/sbnInquiry.asp?userid=...> (barnesandnoble)

Search Engine 8: borders8

Query8: Dog

I) 1) Advanced Gundog Training: Practical Fieldwork & Competition

In stock - ships in 24 hours
 Deeley, Martin ~ Hardcover ~ 1994
 Borders Price: \$27.96 ~ You Save: \$5.99 (20%)...
<http://search.borders.com/cgi-bin/db2www/search/search.d2w/Detail...> (borders)

I) 2) Agility Training: The Fun Sport for All Dogs

In stock - ships in 24 hours
 Simmons-Moake, Jana ~ Trade Paperback ~ 1992
 Borders Price: \$23.36 ~ You Save: \$2.59 (10%)...
<http://search.borders.com/cgi-bin/db2www/search/search.d2w/Detail...> (borders)

I) 3) American Staffordshire Terrier: Gamester & Guardian

In stock - ships in 24 hours
 Foster, Sarah ~ Trade Paperback ~ 1998
 Borders Price: \$22.46 ~ You Save: \$2.49 (10%)...
<http://search.borders.com/cgi-bin/db2www/search/search.d2w/Detail...> (borders)

I) 4) A-Z of Dog Diseases & Health Problems

In stock - ships in 24 hours
 Lane, Dick ~ Trade Paperback ~ 1997
 Borders Price: \$22.46 ~ You Save: \$2.49 (10%)...
<http://search.borders.com/cgi-bin/db2www/search/search.d2w/Detail...> (borders)

I) 5) Baby's Memory Book: A Baby Record Book

In stock - ships in 24 hours
 Nister, Ernest ~ Hardcover ~ 1986
 Borders Price: \$15.99 ~ You Save: \$4.00 (20%)...
<http://search.borders.com/cgi-bin/db2www/search/search.d2w/Detail...> (borders)

I) 6) Anastasia, Absolutely

In stock - ships in 24 hours
 Lowry, Lois ~ Hardcover ~ 1995
 Borders Price: \$12.80 ~ You Save: \$3.20 (20%)...
<http://search.borders.com/cgi-bin/db2www/search/search.d2w/Detail...> (borders)

I) 7) Bark Busters: Solving Your Dog's Behavioral Problems

In stock - ships in 24 hours
 Wilson, Sylvia ~ Trade Paperback ~ 1997
 Borders Price: \$11.66 ~ You Save: \$1.29 (10%)...
<http://search.borders.com/cgi-bin/db2www/search/search.d2w/Detail...> (borders)

I) 8) Adopting the Racing Greyhound

In stock - ships in 24 hours
Branigan, Cynthia A. ~ Trade Paperback ~ 1998
Borders Price: \$11.66 ~ You Save: \$1.28 (10%)...
<http://search.borders.com/cgi-bin/db2www/search/search.d2w/Detail...> (borders)

I) 9) Animal Clinic for Dogs

In stock - ships in 24 hours
Humphries, Jim ~ Hardcover ~ 1998
Borders Price: \$6.39 ~ You Save: \$1.60 (20%)...
<http://search.borders.com/cgi-bin/db2www/search/search.d2w/Detail...> (borders)

I) 10) Baby Animals: Puppies

In stock - ships in 24 hours
Petty, Kate ~ Trade Paperback ~ 1992
Borders Price: \$3.56 ~ You Save: \$0.39 (10%)...
<http://search.borders.com/cgi-bin/db2www/search/search.d2w/Detail...> (borders)

Search Engine 9: google9

Query9: Cat

I) 1) TICA Website

WELCOME TO THE WEB SITE OF THE INTERNATIONAL CAT ASSOCIATION To Navigate the Site Frames No Frames Please See this page as a Shockwave movie. ...
<http://www.tica.org/> (google)

I) 2) The Cat Fanciers' Association (CFA)

Welcome to the Cat Fanciers' Association, the world's largest registry of pedigreed cats! ...
<http://www.cfainc.org/> (google)

I) 3) Feral Cat Coalition

Feral Cat Coalition. San Diego, California. Please follow these links for more information on the subject: Feral Cat Coalition Documents. ...
<http://www.feralcat.com/> (google)

I) 4) Cat Tales Zoological Park

LATEST UPDATE: October 20, 2000. Cat Tales Zoological Park. Do you have what it takes to become a zookeeper? Cat Tales Zoological Training Center. ...
<http://www.cattales.org/> (google)

I) 5) Cat Fancy

or killed playing with toy mice distributed in packages of Fresh Step cat litter, Clorox Co., Oakland, Calif., warned pet owners the toys could strangle or cut ...
<http://www.animalnetwork.com/cats/default.asp> (google)

I) 6) Cat Fanciers Web Site

Welcome to the Cat Fanciers Web Site! We offer General Information about Cats and Cat Care., Cat Breed Descriptions from Abyssinian to Turkish Van., ...
<http://www.fanciers.com/> (google)

I) 7) Cat-Scan.Com - The Cover Page

Welcome to CliffyB's Cat-Scan! Cat-Scan is home to people who love art as much as their cats. So much so, they combine the two! Every weekday we'll bring you ...
<http://www.cat-scan.com/> (google)

I) 8) Beware of Cat! HUGE Cat Graphics Collection & Virtual Cat ...

Cat Postcards! Send an electronic Cat Postcard Now! Hundreds of cute cat cards to choose from! Holidays, Kittens, Cartoons, Love & More! Add Music, Backgrounds ...
<http://www.geocities.com/Hearthland/Meadows/6485/> (google)

I) 9) Arctic Cat > What Drives You to the Great Outdoors?

Arctic Cat. Snowmobile ATV Watercraft Generators Catalogs. What's new on the site? Click ...
<http://www.arctic-cat.com/> (google)

I) 10) Alley Cat Allies

Alley Cat Allies Has a Better Idea. Modeled after successful programs in the United Kingdom and parts of Africa and Europe, Alley Cat Allies (ACA) advocates a ...
<http://www.alleycat.org/> (google)

Preview Order

Look4ithere
Div. of Internet Corporation

- News
- Weather
- Cool Sites
- Shopping
- Contests
- Horoscopes
- Classified

[Visit Look4ithere2](#)

Phone: 1-631-757-1600 • E-Mail: look4ithere@look4ithere.com • Internet Corporation.

Current Group: I

amazon1	borders2	barnesandnoble3	amazon4	amazon5	barnesandnoble6	barnesandnoble7	borders8	google9
Cat	Cat	Cat	Mouse	Dog	Dog	Mouse	Dog	Cat

Go to page: [1](#) [2](#) [3](#) [4](#) [5](#) [6](#) [7](#) [8](#) [9](#)

Search Display (interleaved or separately by search engine):
[Interleave](#) [Combine \[a-z\]](#) [Combine \[z-a\]](#)
[Separate](#) [Separate \[a-z\]](#) [Separate \[z-a\]](#)

Description or List (Site descriptions or lists): [\[List\]](#)

FIG. 61

Look4ItHere

Discovery
Disney, Warner, ABC, Universal, CBS, NBC

Hot Wired
E!Online, Riddler

TV Guide
Reel.com, MusicBlyd, RealAudio, AudioNet

BuyerSellers
Ebay, DrugStore, ShopNow, Vitamin

CIA Kids
eToys, KBkids, Pets, ToysRus, PetSmart

Family
BlueMount, Women, Village, Epicurious

Weather
Intellcast, MapQuest

CitySearch
555-1212, Travelocity, Fodor's, LeisurePlan

ESPN
SportLine, NFL, NBA, SmallWorld, NHL

CNN
NYTimes, WSJournal, USAtoday, ABCnews

StockMaster
CNNfr, Bloomberg, DowJones, Quote

CNet
ZDNet, CMPnet, IDG, Outpost, Jumbo

Monster Board
JobBank, BestJobs, Career, Incpad, Intl

Search'em All! Search your favorite search engines, all at the same time!

Search 1: WebCrawler

Search 2: Allavista

Search 3: Lycos

Search 4: Google

Search 5: Excite

Search 6: Yahoo

Search 7: LookSmart

Search 8: HotBot

Search 9: Dejanews

Search Engine Results: URL's per Search Engine:

URL Details: Timeout (seconds) per Search Engine:

Page: Searches per Group: Group: Only 1 entry required

Flowers for your Valentine

NOW easy ordering at

netMarket Auction VCR Spectacular

Bids start at **1**

February 6, 1998
NEWS ABC NEWS Headlines

U.S. Presence Growing in Iraq

Order Preview

Description	Price	Quantity	Cost
2001 Hello Kitty Wall Calendar In Stock: 24 hours. Cal 2001* (Illustrator) / Wall Calendar / Abrams, Harry N Inc / June 2000 B&N Price: \$4.97 ~ You Save 50% (barnesandnoble)...	\$4.97	<input type="text" value="3"/>	\$14.91
Animal Clinic for Cats In stock - ships in 24 hours Humphries, Jim ~ Hardcover ~ 1998 Borders Price: \$6.39 ~ You Save: \$1.60 (20%) (borders)...	\$6.39	<input type="text" value="1"/>	\$6.39
Mouse Count Usually ships in 24 hours by Ellen Stoll Walsh (Paperback - March 1995) Amazon Price: \$4.95 (amazon)...	\$4.95	<input type="text" value="2"/>	\$9.90
If You Give a Mouse a Cookie Mini Book and Ornament In Stock: 24 hours. Laura Joffe Numeroff, Felicia Bond (Illustrator) / Hardcover / HarperCollins Children's Books / September 2000 B&N Price: \$7.96 ~ You Save 20% (barnesandnoble)...	\$7.96	<input type="text" value="7"/>	\$55.72
2001 Original 365 Dogs Page-A-Day Calendar In Stock: 24 hours. Cal 2001 / Box Calendar / Workman Publishing Company, Inc. / August 2000 B&N Price: \$5.47 ~ You Save 50% (barnesandnoble)...	\$5.47	<input type="text" value="10"/>	\$54.70
How to Housebreak Your Dog in 7 Days Usually ships in 24 hours by Shirlee Kalstone (Paperback - April 1991) Amazon Price: \$6.29 (amazon)...	\$6.29	<input type="text" value="6"/>	\$37.74
Animal Clinic for Dogs In stock - ships in 24 hours Humphries, Jim ~ Hardcover ~ 1998 Borders Price: \$6.39 ~ You Save: \$1.60 (20%) (borders)...	\$6.39	<input type="text" value="5"/>	\$31.95
Bark Busters: Solving Your Dog's Behavioral Problems In stock - ships in 24 hours Wilson, Sylvia ~ Trade Paperback ~ 1997 Borders Price: \$11.66 ~ You Save: \$1.29 (10%) (borders)...	\$11.66	<input type="text" value="4"/>	\$46.64
Dog: The Complete Guide In Stock: 24 hours (Same Day). Sarah Whitehead / Hardcover / Barnes & Noble Books / August 1999 B&N Price: \$14.98 (barnesandnoble)...	\$14.98	<input type="text" value="8"/>	\$119.84
The Dog Owners Home Veterinary Handbook Usually ships in 2-3 days by James M. Clifflin, et al (Hardcover - November 1999) Amazon Price: \$22.36 (amazon)...	\$22.36	<input type="text" value="9"/>	\$201.24
Subtotal			\$579.03
Shipping & Handling			\$63.35
Total			\$642.38

Look4ItHere [News](#) [Weather](#) [Cool Sites](#) [Shopping](#)
[Contests](#) [Horoscopes](#) [Classified](#)

Phone: 1-831-757-1600 • E-Mail: look4itthere@look4itthere.com • Internet Corporation.

FIG. 62

Look4itHere

Discovery
Disney, Warner, ABC, Universal, CBS, NBC

Hot Wired
EOnline, Riddler

TV Guide
Real.com, MusicBvd, RealAudio, AudioNet

BuyerSellers
Ebay, DrugStore, ShopNow, Vitamin

CIA Kids
eToys, KBkids, Pets, ToysRus, PetSmart

Family
BlueMount, Women, Village, Epicurious

Weather
Intellcast, MapQuest

CitySearch
555-1212, Travelocity, Fodor's, LeisurePlan

ESPN
SportsLine, NFL, NBA, SmallWorld, NHL

CNN
NYTimes, WSJournal, USAtoday, ABCnews

StockMaster
CNNfn, Bloomberg, DowJones, Quote

CNet
ZDNet, CMPnet, IDG, Outpost, Jumboc

Monster Board
JobBank, BestJobs, Career, Incpad, Intl

Ship To:

First Name Last Name

Organization Recipient's E-Mail

Street

City State

Country Zip

Pay By:

Credit Card No.

Card/Check Holder's Name Expiration Date

Purchaser's E-Mail Purchaser's Zip Code

Phone Fax

Pay by Check or Money Order

Flowers for your Valentine
ita.com
NOW easy ordering at
Netscape Netcenter
Click Here...

netMarket Auction
VCR Spectacular
Bids start at **1**
Click Now!

February 6, 1998
ABC NEWS Headlines
U.S. Presence Growing in Iraq

Order Preview

Description	Price	Quantity	Cost
2001 Hello Kitty Wall Calendar In Stock: 24 hours. Cal 2001 (Illustrator) / Wall Calendar / Abrams, Harry N Inc / June 2000 B&N Price: \$4.97 ~ You Save 50% (barnesandnoble)...	\$4.97	3	\$14.91
Animal Clinic for Cats In stock - ships in 24 hours Humphries, Jim ~ Hardcover ~ 1998 Borders Price: \$6.39 ~ You Save: \$1.60 (20%) (borders)...	\$6.39	1	\$6.39
Mouse Count Usually ships in 24 hours by Ellen Stoll Walsh (Paperback - March 1995) Amazon Price: \$4.95 (amazon)...	\$4.95	2	\$9.90
If You Give a Mouse a Cookie Mini Book and Ornament In Stock: 24 hours. Laura Joffe Numeroff, Felicia Bond (Illustrator) / Hardcover / HarperCollins Children's Books / September 2000 B&N Price: \$7.96 ~ You Save 20% (barnesandnoble)...	\$7.96	7	\$55.72
2001 Original 365 Dogs Page-A-Day Calendar In Stock: 24 hours. Cal 2001 / Box Calendar / Workman Publishing Company, Inc. / August 2000 B&N Price: \$5.47 ~ You Save 50% (barnesandnoble)...	\$5.47	10	\$54.70
How to Housebreak Your Dog in 7 Days Usually ships in 24 hours by Shirlee Kalstone (Paperback - April 1991) Amazon Price: \$6.29 (amazon)...	\$6.29	6	\$37.74
Animal Clinic for Dogs In stock - ships in 24 hours Humphries, Jim ~ Hardcover ~ 1998 Borders Price: \$6.39 ~ You Save: \$1.60 (20%) (borders)...	\$6.39	5	\$31.95
Bark Busters: Solving Your Dog's Behavioral Problems In stock - ships in 24 hours Wilson, Sylvia ~ Trade Paperback ~ 1997 Borders Price: \$11.66 ~ You Save: \$1.29 (10%) (borders)...	\$11.66	4	\$46.64
Dog: The Complete Guide In Stock: 24 hours (Same Day). Sarah Whitehead / Hardcover / Barnes & Noble Books / August 1999 B&N Price: \$14.98 (barnesandnoble)...	\$14.98	8	\$119.84
The Dog Owners Home Veterinary Handbook Usually ships in 2-3 days by James M. Giffin, et al (Hardcover - November 1999) Amazon Price: \$22.36 (amazon)...	\$22.36	9	\$201.24
Subtotal			\$579.03
Shipping & Handling			\$63.35
Total			\$642.38

Look4itHere
Div. of Internet Corporation

[News](#) [Weather](#) [Cool Sites](#) [Shopping](#)
[Contests](#) [Horoscopes](#) [Classified](#)

Phone: 1-831-757-1600 • E-Mail: look4ithere@look4ithere.com • Internet Corporation.

FIG. 63

Look4ItHere

Discovery
Disney, Warner, ABC, Universal, CBS, NBC

Hot Wired
E!Online, Riddler

TV Guide
Reel.com, MusicBiv, RealAudio, AudioNet

BuyerSellers
Ebay, DrugStore, ShopNow, Vitamin

CIA Kids
eToys, K&Kids, Pets, ToysRus, PetSmart

Family
BlueMount, Women, Village, Epicurious

Weather
IntellCast, MapQuest

CitySearch
555-1212, Travelocity, Fodor's, LeisurePlan

ESPN
SportsLine, NFL, NBA, SmallWorld, NHL

CNN
NYTimes, WSJournal, USAtoday, ABCnews

StockMaster
CNNIn, Bloomberg, DowJones, Quote

CNet
ZDNet, CMPnet, IDG, Outpost, Jumbo

Monster Board
JobBank, BestJobs, Career, Incipad, Inti

Confirmation of Order

Ship To:

First Name Harvey	Last Name Lunenfeld
Organization Internet Corporation	Recipient's E-Mail buyer@buyersellers.com
Street 8 Patrician Drive	
City East Northport	State New York
Country USA	Zip 11731

Pay By:

Credit Card Visa	Credit Card No. 1234-5678-9012-3456
Card/Check Holder's Name Harvey Lunenfeld	Expiration Date 02 2002
Purchaser's Name payee@buyersellers.com	Purchaser's Zip Code 11731
E-Mail	Fax 1-631-757-7575
Phone 1-631-757-1600	

Flowers for your Valentine
tda.com

NOW easy ordering at
N Netscope Netcenter
Click Here...

netMarket Auction
VCR Spectacular

Bids start at **1**

Click Now!

February 6, 1998
NEWS AB: NEWS Headlines
U.S. Presence Growing In Iraq

Order Preview

Description	Price	Quantity	Cost
2001 Hello Kitty Wall Calendar			
In Stock - ships in 24 hours.			
Cal 2001 (Illustrator) / Wall Calendar / Abrams, Harry N Inc / June 2000	\$4.97	3	\$14.91
B&N Price: \$4.97 ~ You Save 50% (barnesandnoble)...			
Animal Clinic for Cats			
In stock - ships in 24 hours			
Humphries, Jim ~ Hardcover ~ 1998	\$6.39	1	\$6.39
Borders Price: \$6.39 ~ You Save: \$1.60 (20%) (borders)...			
Mouse Count			
Usually ships in 24 hours			
by Ellen Stoll Walsh (Paperback - March 1995)	\$4.95	2	\$9.90
Amazon Price: \$4.95 (amazon)...			
If You Give a Mouse a Cookie Mini Book and Ornament			
In Stock: 24 hours.			
Laura Joffe Numeroff, Felicia Bond (Illustrator) / Hardcover / HarperCollins Children's Books / September 2000	\$7.96	7	\$55.72
B&N Price: \$7.96 ~ You Save 20% (barnesandnoble)...			
2001 Original 365 Dogs Page-A-Day Calendar			
In Stock: 24 hours.			
Cal 2001 / Box Calendar / Workman Publishing Company, Inc. / August 2000	\$5.47	10	\$54.70
B&N Price: \$5.47 ~ You Save 50% (barnesandnoble)...			
How to Housebreak Your Dog in 7 Days			
Usually ships in 24 hours			
by Shirlee Kalstone (Paperback - April 1991)	\$6.29	6	\$37.74
Amazon Price: \$6.29 (amazon)...			
Animal Clinic for Dogs			
In stock - ships in 24 hours			
Humphries, Jim ~ Hardcover ~ 1998	\$6.39	5	\$31.95
Borders Price: \$6.39 ~ You Save: \$1.60 (20%) (borders)...			
Bark Busters: Solving Your Dog's Behavioral Problems			
In stock - ships in 24 hours			
Wilson, Sylvia ~ Trade Paperback ~ 1997	\$11.66	4	\$46.64
Borders Price: \$11.66 ~ You Save: \$1.29 (10%) (borders)...			
Dog: The Complete Guide			
In Stock: 24 hours (Same Day).			
Sarah Whitehead / Hardcover / Barnes & Noble Books / August 1999	\$14.98	8	\$119.84
B&N Price: \$14.98 (barnesandnoble)...			
The Dog Owners Home Veterinary Handbook			
Usually ships in 2-3 days			
by James M. Giffin, et al (Hardcover - November 1999)	\$22.36	9	\$201.24
Amazon Price: \$22.36 (amazon)...			
Subtotal			\$579.03
Shipping & Handling			\$63.35
Total			\$642.38

Look4ItHere
Div. of Internet Corporation

[News](#) [Weather](#) [Cool Sites](#) [Shopping](#)
[Contests](#) [Horoscopes](#) [Classified](#)

Visit [Look4ItHere2](#)

Phone: 1-631-757-1600 • E-Mail: look4itthere@look4itthere.com • Internet Corporation, .



CHOOSE YOUR NEXT CAR:

Gnome Prefers

Isuzu Hombre
 Cadillac Catera
 Pontiac Sunfire

Car shopping made easy.

- Discovery**
Disney, Warner, ABC, Universal, CBS, NBC
- Hot Wired**
E!Online, Riddler
- TV Guide**
Reel.com, MusicBlvd, RealAudio, AudioNet
- BuyerSellers**
Ebay, DrugStore, ShopNow, Vitamin
- CIA Kids**
eToys, KBkids, Pets, ToysRus, PetSmart
- Family**
BlueMount, Women, Village, Epicurious
- Weather**
Intellicast, MapQuest
- CitySearch**
555-1212, Fodor's, Travelocity
- ESPN**
SportsLine, NFL, NBA, SmallWorld, NHL
- CNN**
NYtimes, WSJournal, USAtoday, ABCnews
- StockMaster**
CNNfn, Bloomberg, DowJones, Quote
- CNet**
ZDNet, CMPnet, IDG, Outpost, Jumbo
- Monster Board**
JobBank, BestJobs, Career, Incpad, Intl

Search

Search 1	WebCrawler
Search 2	Altavista
Search 3	Lycos
Search 4	Google
Search 5	Excite
Search 6	Yahoo
Search 7	LookSmart
Search 8	HotBot
Search 9	Dejanews
Search 10	Amazon.com

Interleave [10]

Summary [3]

[1] [3] [1]

- * Multiple simultaneous same and/or different searches of the same and/or different sites
- Autos**
Buy, Cars, Racing
 - Business**
Investments, Funds, Companies, Industry
 - Careers**
Jobs, Universities, Education
 - Entertainment**
Movies, Music, TV, Games, Chat
 - Fashion**
Designers, Style, Models
 - Free Stuff**
Contests, Cool Sites, Shopping
 - Health**
Drugs, Diseases, News
 - Homes**
Food, Wine, Gardening
 - Issues**
Government, Politics, Taxes, Editorials
 - People**
Relationships, Dating, Psychology
 - Society**
Philosophy, Economics, Religion, Sociology
 - Sports**
Baseball, Basketball, Football, Hockey
 - Technology**
Computers, Environment, Engineering, Internet
 - Travel**
Maps, Vacations, Fares

CHOOSE YOUR NEXT CAR:

Car shopping made easy.

Isuzu Hombre
 Cadillac Catera
 Pontiac Sunfire

Flowers for your Valentine

NOW easy ordering at

Click Here...

netMarket Auction VCR Spectacular

Bids start at **\$1**

Click Now!

- Top Stories**
- Mid-East war of words...
 - California power order extended...
 - Shooting ends tense White House standoff...
 - Jury Awards Stroke Victim \$12 Million...
 - White House gunman in custody...
 - Sharon Seeks to Enlist Support of His Rivals...
 - 15 Scientologists on Trial in Spain...
 - Book Calling Holocaust a Shakedown Starts a German Storm...
 - UN warns BSE risk could be global...

Internet Corporation. Phone: 1-631-757-1600 · E-Mail: internet2@internet2.com

FIG. 64

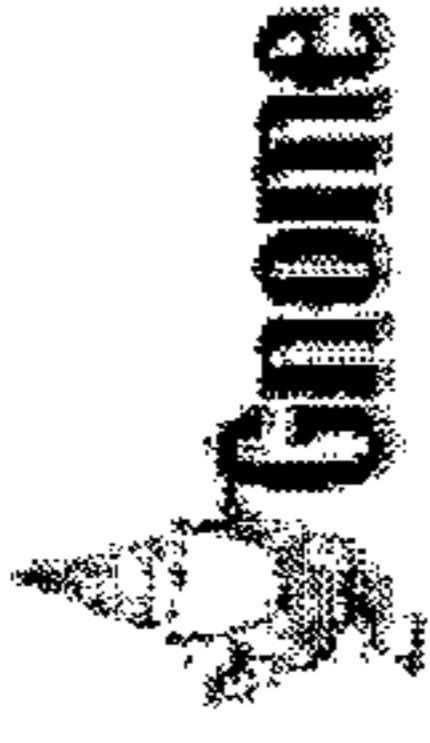

Free Stuff
Contests, Cool Sites, Shopping

Discovery
Disney, Warner, ABC, Universal, CBS, NBC

Hot Wired
E!Online, Riddler

TV Guide
Reel.com, MusicBlvd, RealAudio, AudioNet

Ebay
eToys, KBkids, Pets, ToysRus, PetSmart

Family
BlueMount, Women, Village, Epicurious

CitySearch
555-1212, Fodbr's, Travelocity

StockMaster
CNNin, Bloomberg, DowJones, Quote

CHOOSE YOUR NEXT CAR:

Isuzu Hombre
 Cadillac Catera
 Pontiac Sunfire

Car shopping made easy. 

WebCrawler
 Altavista
 Lycos
 Google
 Excite

Search'em All

Results: Interleave
 URL's per Search Engine: 10
 URL Details: Summary

Timeout/Search Engine (seconds): 3
 Page: 1
 Searches per Group: 3
 Group: 1

Multiple Queries of the Same/Different Search Engines at the Same Time

- **Autos**
Buy, Cars, Racing
- **Business**
Investments, Funds, Industry
- **Careers**
Jobs, Universities, Education
- **Entertainment**
Movies, Music, TV, Games, Chat
- **Fashion**
Design, Models
- **Health**
Care, Drugs, News
- **Homes**
Food, Wine, Garden
- **Issues**
Gov't Politics
- **People**
Psychology, Dating, Relationships
- **Society**
Sociology, Economy, Philosophy
- **Sports**
Baseball, Basketball, Football, Hockey
- **Technology**
Computers, Internet, Environment, Englg
- **Travel**
Maps, Vacations, Fares
- **Top Stories**
White House Reverses, Will Keep AIDS, Race Offices...
Lockerbie Libyan lodges appeal...
Russia and Japan poles apart over disputed isles...
United and Yankees to form superclub...
Sharon begins work on new government...

Yahoo
 LookSmart
 HotBot
 DeJavews
 Amazon

netMarket Auction
VCR Spectacular
Bids start at
Click Now!

Weather
[Intellicast](#), [MapQuest](#)

CNN
[NYtimes](#), [WSjournal](#), [USAtoday](#), [ABCnews](#)

ESPN
[SportsLine](#), [NFL](#), [NBA](#), [SmallWorld](#), [NHL](#)

Flowers for your Valentine
[flor.com](#)
 NOW easy ordering at **Netcape Netcenter**
[Click Here...](#)

[Get your dot.com](#)
 WWW | 408-442-1616 | .COM

Internet Phone: 1-631-757-1600 · E-Mail: gnome@gnome.com · Internet Corporation.

FIG. 65

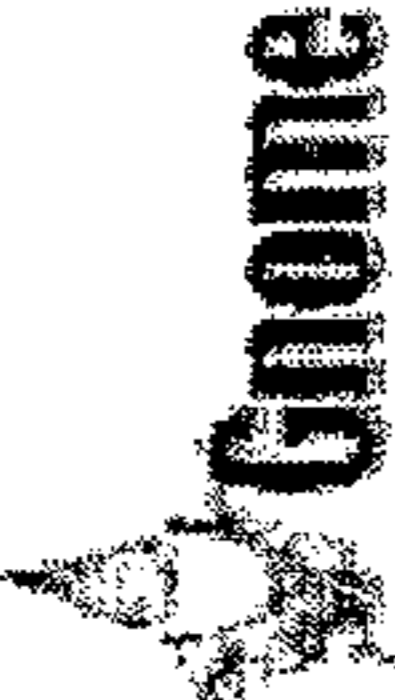

Free Stuff
Contests, Cool Sites, Shopping

Discovery
Disney, Warner, ABC, Universal, CBS, NBC

Hot Wired
E!Online, Riddler

TV Guide
Reel.com, MusicBlvd, RealAudio, AudioNet

Ebay
eToys, KBkids, Pets, ToysRus, PetSmart

Family
BlueMount, Women, Village, Epicurious

CitySearch
555-1212, Fodbr's, Travelocity

StockMaster
CNNfn, Bloomberg, DowJones, Quote

CHOOSE YOUR NEXT CAR:

Isuzu Hombre
 Cadillac Catera
 Pontiac Sunfire

cars
 boats
 cabs
 cars
 airplanes
 cars

WebCrawler
 Altavista
 Lycos
 Google
 Excite

Search'em All

Results:
 URL's per Search Engine:
 URL Details:

Timeout/Search Engine (seconds):
 Page:
 Searches per Group:
 Group:

Multiple Queries of the Same/Different Search Engines at the Same Time

Car shopping made easy.



Flowers for your Valentine
NOW easy ordering at [NetScape](#) [Netcenter](#)
Click Here...

netMarket Auction VCR Spectacular
Bids start at
Click Now!

Weather
Intellicast, MapQuest

CNN
NYTimes, WSJournal, USAtoday, ABCnews

ESPN
SportsLine, NFL, NBA, SmallWorld, NHL

Autos
Buy, Cars, Racing

Business
Investments, Funds, Industry

Careers
Jobs, Universities, Education

Entertainment
Movies, Music, TV, Games, Chat

Fashion
Design, Models

Health
Care, Drugs, News

Homes
Food, Wine, Garden

Issues
Gov't, Politics

People
Psychology, Dating, Relationships

Society
Sociology, Economy, Philosophy

Sports
Baseball, Basketball, Football, Hockey

Technology
Computers, Internet, Environment, Engg

Travel
Maps, Vacations, Fares

Top Stories
White House Reverses, Will Keep AIDS, Race Offices...
Lockerbie Libyan lodges appeal...
Russia and Japan poles apart over disputed isles...
United and Yankees to form superclub...
Sharon begins work on new government...

trains cars trains trains trains

BarnesNoble LookSmart HotBot Borders Amazon

Internet Phone: 1-631-757-1600 · E-Mail: gnome@gnome.com
Internet Corporation.

FIG. 66

FIG. 67



Free Stuff
Contests, Cool Sites, Shopping

Discovery
Disney, Warner, ABC, Universal, CBS, NBC

Hot Wired
E!Online, Riddler

TV Guide
Real.com, MusicBlvd, RealAudio, AudioNet



Ebay
Toys, KBkids, Pets, ToysRus, PetSmart

Family
BlueMount, Women, Village, Epicurious

CitySearch
555-1212, Fodor's, Travelocity

StockMaster
CNN, Bloomberg, Dow Jones, Quote

CHOOSE YOUR NEXT CAR:

Car shopping made easy. cars.com



Flowers for your Valentine ted.com

HOW easy ordering at [Netcenter](http://netcenter)

netMarket Auction **VCR Spectacular**

Bids start at **1**

Click Now!

Weather Intellicast, MapQuest

CNN NYTimes, WSJ, USA Today, ABC News

ESPN Sportsline, NFL, NBA, SmallWorld, NHL

WebCrawler | Allavista | Lycos | Google | Excite

Multiple Queries of the Same/Different Search Engines at the Same Time

Results: URL's per Search Engine: URL Details:

Timeout/Search Engine (seconds): Page: Searches per Group: Group:

Yahoo | LookSmart | HotBot | Dejanews | Amazon

Search Engine Report

Order Quantity Below

Query: cars

1) 1) Airline tickets, hotels, cars, vacations: Go Virtually Anywhere with Travelocity.com
Welcome to Travelocity.com! Already a member? Click here to log in My Trips | My Account Site Shortcuts - My Trips Customer Service - Travel Menu VIA Rail Canada ...
<http://www.travelocity.com/> (lycos)

1) 2) AuHo? The Automobiles Homepage!
AuHo, autoinfo, thiscar, Alfa, Romeo, Autobianchini, Acura, Aston Martin, AUDI, BMW, Cadillac, Chevrolet, Chrysler, Citroen, Daewoo, Dodge, Fiat, Ford, General...
<http://www.auho.com/> (hotbot)

1) 3) Auto.com - Daily news and reviews
Auto.com is the Web's premier site for information on the auto industry, motor sports and consumer news about motor vehicles. It is a daily publication by the Detroit Free Press...
<http://www.auto.com/> (hotbot)

1) 4) Autobytel.com - Changing the way America buys cars... Again. Autobytel.com
Site Shortcuts Buy a vehicle Sell my vehicle Owning my vehicle Customer Survey Pressroom - New vehicles Used vehicle Maintenance Financing Insurance Warranty My Garage For Her Resources -...
<http://www.autobytel.com/> (lycos)

1) 5) Autorow
...
<http://www.autorow.com/> (excite)

1) 6) AutoVantage - Home
...
<http://www.autovantage.com/> (excite)

1) 7) Autoweb.com
...
<http://www.autoweb.com/> (excite)

1) 8) BMW Automobile Enthusiasts Page.
Not affiliated with any company (like BMW NA or BMW AG). This server provides info gathered from many sources, mostly the e-mail list. No checking for accuracy is done, use at your own risk. ...
<http://cbgsj1.bu.edu/bmw/bmw.html> (webcrawler)

1) 9) British Cars Web - Scions of Lucas
The Scions of Lucas is the oldest & largest collection of British Car related e-mail lists, Marque & Model web lists, club listing, parts sources, tech information, events, and anything else re...
<http://www.team.net/sol/> (webcrawler)

1) 10) car crazy
San Diego Magazine, the nation's first city magazine, also has one of the first city websites. San Diego OnLine is complete with information about San Diego and content from the...
<http://www.sandiego-online.com/carcrazy/> (hotbot)

1) 11) Cars-Rentals-Discounts.com "The Ultimate Car Rentals Reservation Service"
1/19/2001 Cars-Rentals-Discounts.com is a comprehensive web site designed for the consumer to compare prices for the major car rental companies. Allowing you to get the best deals searching all companies...
<http://www.cars-rentals-discounts.com/> (lycos)

1) 12) cars.com
...
<http://www.cars.com/> (lycos)

1) 13) CarSmart: Home Page
Click Centers >, Click Below CarSmart and the CarSmart logos are registered trademarks of A.I.N. Designed by A.I.N. *, Insurance Center *, Finance Center ...
<http://www.carsmart.com/> (excite)

1) 14) Cars On Line Photo Ads
Cars On Line Photo Ads, classic cars for sale, for sale by owner cars...
<http://www.cars-on-line.com/> (hotbot)

1) 15) Classic Auto Registry Service
Buy, sell, trade and locate antique, classic and collectible automobiles around the world.
...
<http://www.kars.com/> (webcrawler)

1) 16) ClassicCar.com - 'Where Car Lovers Click' classic cars, chats, forums, articles.
The oldest and largest online community for classic car hobbyists, featuring realtime chats, forums, clubs & museums, news articles, searchable databases and tech tips with Ted...
<http://www.classicar.com/home.htm> (hotbot)

I) 17) Click For The Online Auto Scorecard

...
http://r.hotbot.com/rily_res_GT_inline/http://www.goto.com/dlr?x... (lycos)

I) 18) Cool Cars

Brake for these cars. Make a puzzle or picture of a Ferrari, Porsche, Dodge or many other cars. You'll feel almost ready to drive after going here!...
http://bonus.lycos.com/bonus/card/scs_workshop_cars.html (lycos)

I) 19) Did you get your AutoSite Report?

...
<http://www.autosite.com/> (excite)

I) 20) Excite Autos

Shop Excite Excite, @Home, and the Excite and @Home logos are service marks or registered service marks of At Home In the U.S. and other countries. Click Here! ...
<http://autos.excite.com/> (excite)

I) 21) Fast, Low Price Quotes on a New Car

...
http://r.hotbot.com/rily_res_GT_inline/http://www.goto.com/dlr?x... (lycos)

I) 22) Fish4: News and sport, cars, homes, jobs, business search, shopping, entertainment and travel

Around Fish4 - Fish4Homepage About Fish4 Cars Directory Local Sites Entertainment Homes Jobs Shopping Travel Contact Us Cars Homes Jobs Directory Local Sites Entertainment Shopping Travel Contact Us H...
<http://www.fish4.co.uk/> (lycos)

I) 23) Kelley Blue Book - New Car Pricing, Used Car Bluebook Values

...
<http://www.kbb.com/> (excite)

I) 24) Lycos RoadMaps

car buying info Lycos® is a registered trademark of Carnegie Mellon University. Our Privacy Vow Terms and Conditions Standard Advertising Terms and Conditions ...
<http://www.lycos.com/roadmap.html> (webcrawler)

I) 25) Microsoft CarPoint - cars, autos, automobiles, trucks, miniv...

New cars, autos, and automobiles and more are available for at the New Car Buying Service from Microsoft CarPoint. Use this free online car buying service to get a great price on your next new car with...
<http://www.carpoint.msn.com/> (webcrawler)

I) 26) Money & Investing by Quicken.com

Shopping Home · Autos · Travel · Auctions · Where to Shop · Reviews · Compare Prices Where to Shop Product Reviews ...
http://quicken.webcrawler.com/shopping/best_bets/autos/ (webcrawler)

I) 27) MotoMail Lobby

Welcome to the MotoMail The automotive enthusiast's playground Enter the Mail Autoconnect High Octane Award AEA Award Site ...
<http://www.motomail.com/> (webcrawler)

I) 28) Motor Trend: World's #1 Automotive Authority

The World's Automotive Authority offers 1999 buyer's guide, performance database, road tests, auto news, BBS, chat, MT TV schedules, money-saving buying features, and a fun-filled...
<http://www.motortrend.com/> (hotbot)

I) 29) MSN CarPoint - Home

MSN CarPoint is the best way to research for and buy new or used cars, autos, automobiles, trucks and other vehicles on the Internet. It features invoice prices, car reviews, auto...
<http://carpoint.msn.com/> (hotbot)

I) 30) New and used cars and trucks online

Locate a used car or truck near you. All makes and models available. We find what you want at the lowest price! ...
<http://www.all-auto.net/> (webcrawler)

I) 31) New cars and trucks online

Buy a new car or truck online. Low sticker prices for all makes and models. ...
<http://www.all-auto.com/> (webcrawler)

I) 32) Rental Cars & Car Rentals, Rental Cars @ Airports

...
<http://www.bnm.com/rcar.htm> (excite)

I) 33) Searchwho.com - Auto Racing page featuring tons of NASCAR links and info but also with links for drag racing, indy formula one cars, sprint cars, and

even the women of racing plus information on business, music, sports, travel, news, health December 27, 2000 13:13 The best of the web for auto racing/nascar Welcome to the top web sites for auto raci...
<http://nascar.searchwho.com/> (lycos)

I) 34) The Auto Channel's MAIN STUDIO

Welcome to The Auto Channel studio. From here you have access to the entire site, including the latest news articles and live coverage of motorsports events...
<http://www.theautochannel.com/> (hotbot)

I) 35) The R/C Web Directory

The most comprehensive guide to radio controlled modeling resources on the World Wide Web. A free service sponsored by Tower Hobbies. ...
<http://www.towerhobbies.com/rcweb.html> (webcrawler)

I) 36) Trader Online Classified Ads

TraderOnline is the leader in online classifieds for used and new cars, trucks, boats, RVs, cycles, big trucks, aircraft, and general merchandise...
<http://www.traderonline.com/> (hotbot)

I) 37) Used Cars, Sell Your Car, Auto Financing Insurance - AutoTrader.com Home

Search the largest inventory of cars and trucks on the Internet. More than 1.5 million listings, updated daily. Used Cars New Cars Select Make Acura Alfa Romeo AMC AM General Aston Martin Asuna Auburn...
<http://www.autotrader.com/> (lycos)

I) 38) www.carlist.com-New Cars,Car Financing,Auto Insurance,New Car Price Quote,Carclubs,Classifieds,Used Cars for Sale

www.carlist.com-Get a new car price quote, car insurance, auto financing and extended warranties. Look for a used car.Locate a carclub from around the world or list your carclub for free. ...
<http://navigation.realnames.com/resolver.dll?action=navigation&pr...> (excite)

Query: boats

I) 1) boats.com

The complete marine portal for powerboating, fishing and sailing.....
<http://www.boats.com/> (altavista)

I) 2) Boats For Sale

Boats For Sale.....
<http://fishingpal.com/forsale/bfs/bfs.html> (altavista)

I) 3) Internet Boats

Be in touch with boat dealers and browse classified ads with the help of this boating resource. Offers insurance details and boat auctions....
<http://www.internetboats.com/> (altavista)

I) 4) JBoats, Inc.

JBoats, Inc. Web Site: Featuring Latest News, Brochure Information, Class & Owner Forums, And Sailing Links...
<http://www.jboats.com/> (altavista)

I) 5) Lund Boats - A Tradition of Quality

Manufacturer of sports and fishing vessels provides specs of all models in the line. Furnishes company contacts and history....
<http://www.lundboats.com/> (altavista)

I) 6) Malibu Boats

Check out the new line of ski boats. Manufacturer offers photos and profiles of its power boats, as well as related articles and competitions....
<http://www.malibuboats.com/> (altavista)

I) 7) Saltwater Boats for Sale Message Board

The Saltwater Fishing Home Page is the world's #1 site for information on Big Game Saltwater Fishing. Site includes fishing reports, articles,.....
http://www.wmi.org/saltfish/boats_for_sale/index.html (altavista)

I) 8) Sea Ray Boats

Look through the catalog of sports boats, cruisers and yachts, and shop for accessories in the Sea Ray store. Includes a dealer locator....
<http://www.searay.com/> (altavista)

I) 9) The Boat Shop - Project Boats Home Page

The Boat Shop's Classified Ads Page - Boat and Marine related private advertisements....
<http://www.boatmall.com/ProjectBoats/default.htm> (altavista)

I) 10) Thefishfinder.com The Fishing Search Engine: Boats

Worldwide Boat listings Manufacturers, Dealers, Accessories, Marinas and more...
<http://www.thefishfinder.com/links/boats/> (altavista)

Query: airplanes

I) 1) 50 fold-em-up paper airplanes, The Greatest Paper Airplanes

Ordering, Support. The Greatest Paper Airplanes 50 traditional fold-em-up paper airplanes Software for Windows and Macintosh. ...
<http://www.khs.com/aboutgpa.htm> (google)

I) 2) Alex's paper airplanes

Free paper airplanes, paper helicopters and gliders, LEARN TO FLY
[paperairplanes.co.uk](http://www.paperairplanes.co.uk/) - Alex's Paper Airplanes, Alex 17 th December 2000. Paper Airplanes. ...
<http://www.paperairplanes.co.uk/> (google)

I) 3) Boeing: Military Aircraft

Tests. Boeing Home | Military Airplanes Copyright (c) 2000 The Boeing Company - All rights reserved ...
<http://www.boeing.com/defense-space/military/> (google)

I) 4) HOME PAGE

This page uses frames, but your browser doesn't support them. ...
<http://www.geocities.com/CapeCanaveral/1817/> (google)

I) 5) Howstuffworks.com's "How Airplanes Work"

I happen to fly a lot on business. For me, personally, airplanes are one of the most amazing things that I see on a daily basis. When I get on a 747, I am ...
<http://www.howstuffworks.com/airplane.htm> (google)

I) 6) Jline Paper Airplanes

Judson Lee, Designer and editor Copyright (c) 1999-2000 Jline Paper Airplanes. All rights reserved. Revised: December 11, 2000
<http://www.freehomepages.com/jline/> (google)

I) 7) Kool Paper Airplanes

Spain Brainshare.com "HotSite of the Day" (Philippines), Welcome to the Kool Paper Airplanes! .Please bookmark this page and try folding some of our cool paper ...
<http://koolpaperairplanes.hypermart.net/> (google)

I) 8) PAPER AIRPLANES

The Edutainment Catalog. PAPER AIRPLANES - QUICK AND SIMPLE! To make your airplanes really special, you can paint a picture on the paper before you fold it ...
<http://www.onenorthpole.com/ToyShop/Paperairplanes.html> (google)

I) 9) Radio Control Airplanes

Radio Control Airplanes. - by Michael Myers. Contents: Scroll down to see: Scale models I've built ...
<http://www.netaxs.com/~mhmyers/rc.tn.html> (google)

I) 10) World War II Airplanes Home Page

Airplanes of the Second World War. A Small History and Information Page. This page is a tribute ...
<http://www.tznet.com/mader/> (google)

Query: trains

I) 1) Thomas and the Magic Railroad: Diesel 10 Means Trouble

In Stock: 24 hours (Same Day).
 Britt Allcroft, Richard Courtney (Illustrator) / Paperback / Random House Books for Young Readers / May 2000
 B&N Price: \$2.92 ~ You Save 10%...
<http://shop.barnesandnoble.com/booksearch/ISBNInquiry.asp?userid=...> (barnesandnoble)

I) 2) On Becoming Baby Wise: How 100,000 New Parents Trained their Babies to Sleep through the Night the Natural Way

In Stock: 24 hours (Same Day).
 Gary Ezzo, Robert Bucknam / Paperback / Multnomah Publishers, Inc. / February 1996
 B&N Price: \$3.98 ~ You Save 60%...
<http://shop.barnesandnoble.com/booksearch/ISBNInquiry.asp?userid=...> (barnesandnoble)

- I) 3) 2001 Classic Trains Wall Calendar**
 In Stock: 24 hours (Same Day).
 Cal 2001 / Wall Calendar / Barnes & Noble Books / June 2000
 B&N Price: \$5.47 ~ You Save 50%...
<http://shop.barnesandnoble.com/booksearch/isbnInquiry.asp?userid=...> (barnesandnoble)
- I) 4) The Little Engine That Could**
 Usually ships in 24 hours
 by Watty Piper, et al(Hardcover - June 1978)
 Amazon Price: \$6.39...
<http://www.amazon.com/exec/obidos/ASIN/0448405202/qid=982169113/s...> (amazon)
- I) 5) Adopting Cats & Kittens: A Care & Training Guide**
 Ships within 2-3 days
 Jankowski, Connie ~ Trade Paperback ~ 1993
 Borders Price: \$7.20 ~ You Save: \$0.80 (10%)...
<http://search.borders.com/cgi-bin/db2www/search/search.d2w/Detai...> (borders)
- I) 6) Inside Freight Train**
 Usually ships in 2-3 days
 by Donald Crews(illustrator)(Hardcover - January 2001)
 Amazon Price: \$7.96...
<http://www.amazon.com/exec/obidos/ASIN/0688170870/qid=982169113/s...> (amazon)
- I) 7) Greenberg Guides Lionel Trains : Pocket Price Guide (Greenberg's Pocket Price Guide to Lionel Trains, 2001)**
 Usually ships in 2-3 days
 by Kent J. Johnson(Editor)(Paperback - October 2000)
 Amazon Price: \$9.56...
<http://www.amazon.com/exec/obidos/ASIN/0697784685/qid=982169113/s...> (amazon)
- I) 8) Chugga-Chugga Choo-Choo**
 Usually ships in 24 hours
 by Kevin Lewis, Daniel Kirk(illustrator)(Hardcover - May 1999)
 Amazon Price: \$10.39...
<http://www.amazon.com/exec/obidos/ASIN/0786804297/qid=982169113/s...> (amazon)
- I) 9) On Becoming Babywise: Learn how over 500,000 Babies Were Trained to Sleep through the Night the Natural Way**
 In Stock: 24 hours.
 Gary Ezzo,Foreword by Robert Bucknam / Paperback / Multnomah Publishers, Inc. / May 1998
 B&N Price: \$10.79 ~ You Save 10%...
<http://shop.barnesandnoble.com/booksearch/isbnInquiry.asp?userid=...> (barnesandnoble)
- I) 10) 3-Minute Abs: Achieving the Look You've Always Wanted in Only 3 Minutes a Day**
 In stock - ships in 24 hours
 Brungardt, Kurt ~ Trade Paperback ~ 1998
 Borders Price: \$10.80 ~ You Save: \$1.20 (10%)...
<http://search.borders.com/cgi-bin/db2www/search/search.d2w/Detai...> (borders)
- I) 11) Selling to Vito: The Very Important Top Officer**
 In Stock: 24 hours (Same Day).
 Anthony Parinello,Foreword by Denis Waitley / Paperback / Adams Media Corporation / August 1999
 B&N Price: \$11.65 ~ You Save 10%...
<http://shop.barnesandnoble.com/booksearch/isbnInquiry.asp?userid=...> (barnesandnoble)
- I) 12) ACLS: Quick Review Study Guide**
 In stock - ships in 24 hours
 Aehlert, Barbara ~ Paperback ~ 1993
 Borders Price: \$13.95 ...
<http://search.borders.com/cgi-bin/db2www/search/search.d2w/Detai...> (borders)
- I) 13) Full Steam Ahead : The Race to Build a Transcontinental Railroad**
 Usually ships in 24 hours
 by Rhoda Blumberg, Rhonda Blumberg(Hardcover - May 1996)
 Amazon Price: \$15.15...
<http://www.amazon.com/exec/obidos/ASIN/0792227158/qid=982169113/s...> (amazon)
- I) 14) The Art of Raising a Puppy**
 In Stock: 24 hours.
 The Monks of New Skete / Hardcover / Little, Brown & Company / March 1991
 B&N Price: \$19.16 ~ You Save 20%...
<http://shop.barnesandnoble.com/booksearch/isbnInquiry.asp?userid=...> (barnesandnoble)
- I) 15) Abdominal Training**
 Ships within 2-3 days
 Norris, Christopher ~ Trade Paperback ~ 1997
 Borders Price: \$19.95 ...
<http://search.borders.com/cgi-bin/db2www/search/search.d2w/Detai...> (borders)
- I) 16) Complete Service Manual for Lionel Trains**
 Usually ships in 1-2 weeks
 by Maury D. Klein(Hardcover)
 Amazon Price: \$19.95...
<http://www.amazon.com/exec/obidos/ASIN/0934580049/qid=982169113/s...> (amazon)
- I) 17) The New Encyclopedia of Modern Bodybuilding**
 In Stock: 24 hours (Same Day).
 Arnold Schwarzenegger,Bill Dobbins / Paperback / Simon & Schuster Trade Paperbacks / October 1999
 B&N Price: \$20.00 ~ You Save 20%...
<http://shop.barnesandnoble.com/booksearch/isbnInquiry.asp?userid=...> (barnesandnoble)
- I) 18) The Orphan Trains : The Story of Charles Loring Brace and the Children He Saved and Failed**
 Usually ships in 24 hours
 by Stephen O'Connor(Hardcover)
 Amazon Price: \$20.80...
<http://www.amazon.com/exec/obidos/ASIN/0395841739/qid=982169113/s...> (amazon)
- I) 19) Topgrading: How Leading Companies Win by Hiring, Coaching and Keeping the Best People**
 In-Stock: Ships 2-3 days.
 Bradford D. Smart / Hardcover / Prentice Hall Press / January 1999
 B&N Price: \$20.80 ~ You Save 20%...
<http://shop.barnesandnoble.com/booksearch/isbnInquiry.asp?userid=...> (barnesandnoble)
- I) 20) Agility Training: The Fun Sport for All Dogs**
 In stock - ships in 24 hours
 Simmons-Moake, Jane ~ Trade Paperback ~ 1992
 Borders Price: \$23.36 ~ You Save: \$2.59 (10%)...
<http://search.borders.com/cgi-bin/db2www/search/search.d2w/Detai...> (borders)

- I) 21) **A-Train: Memoirs of a Tuskegee Airman**
In stock - ships in 24 hours
Dryden, Charles W. ~ Hardcover ~ 1997
Borders Price: \$23.96 ~ You Save: \$5.99 (20%)...
<http://search.borders.com/cgi-bin/db2www/search/search.d2w/Detal...> (borders)
- I) 22) **Lionel: America's Favorite Toy Trains**
Usually ships in 24 hours
by Gerry Souter, Janet Souter(Hardcover - October 2000)
Amazon Price: \$23.96...
<http://www.amazon.com/exec/obidos/ASIN/0760305056/qid=582169113/s...> (amazon)
- I) 23) **Aids to Postgraduate Medicine**
In stock - ships in 24 hours
Burton, J. L. ~ Paperback ~ 1994
Borders Price: \$24.00 ...
<http://search.borders.com/cgi-bin/db2www/search/search.d2w/Detal...> (borders)
- I) 24) **Aircrew Unlimited: The Commonwealth Air Training Plan during WWII**
In stock - ships in 24 hours
Golley, John ~ Hardcover ~ 1994
Borders Price: \$26.36 ~ You Save: \$6.59 (20%)...
<http://search.borders.com/cgi-bin/db2www/search/search.d2w/Detal...> (borders)
- I) 25) **Advanced Gundog Training: Practical Fieldwork & Competition**
In stock - ships in 24 hours
Deeley, Martin ~ Hardcover ~ 1994
Borders Price: \$27.96 ~ You Save: \$6.99 (20%)...
<http://search.borders.com/cgi-bin/db2www/search/search.d2w/Detal...> (borders)
- I) 26) **Complete Service Manual for American Flyer Trains**
Usually ships in 24 hours
by Maury Klein(Hardcover)
Amazon Price: \$29.95...
<http://www.amazon.com/exec/obidos/ASIN/0934580065/qid=582169113/s...> (amazon)
- I) 27) **Dreamweaver 3 Hands-On Training**
In Stock: 24 hours.
Lynda Weinman,Garo Green / Paperback / Peachpit Press / July 2000
B&N Price: \$31.99 ~ You Save 20%...
<http://shop.barnesandnoble.com/booksearch/fsbnInquiry.asp?usend=...> (barnesandnoble)
- I) 28) **Advanced Sightinging & Ear Training: Strategies & Applications**
In stock - ships in 24 hours
Benward, Bruce ~ Spiral Bound ~ 1969
Borders Price: \$32.50 ...
<http://search.borders.com/cgi-bin/db2www/search/search.d2w/Detal...> (borders)
- I) 29) **MCSE Training Kit Microsoft Windows 2000 Core Requirements with Cdrom and Book**
In Stock: 24 hours (Same Day).
Microsoft Corporation / Paperback / Microsoft Press / June 2000
B&N Price: \$159.99 ~ You Save 20%...
<http://shop.barnesandnoble.com/booksearch/fsbnInquiry.asp?userid=...> (barnesandnoble)
- I) 30) **America's Railroads on Parade**
Check out this collection of over 4,000 square feet of automated trains, hands-on exhibits and train-related art. Find directions...
<http://www.trains.ontheline.com/> (looksmart)
- I) 31) **Amtrak and Freight Trains**
Peruse a collection of photographs and .wav files dedicated to Amtrak trains. Also find information about Amtrak models and train related links...
<http://trainweb.com/indamtrak199/> (looksmart)
- I) 32) **Dollhouses, Trains & More**
Choose a department and shop for Thomas the Tank Engine, doll houses, radio control toys, trains or miniatures...
<http://www.dollhouses-trains-more.com/> (looksmart)
- I) 33) **Internet Model Trains**
Find more than 13,000 different model trains and railroading products, including Lionel, toy trains, train sets, books, videos and software...
<http://www.internettrains.com/> (looksmart)
- I) 34) **Thomas the Tank Engine : The Complete Collection**
by Wilbert Vere Awdry, Brian Sibley(Afterword)(Hardcover - September 1997) Usually ships in 24 hours ...
<http://www.amazon.com/exec/obidos/ASIN/0517187868/qid=582169113/s...> (amazon)
- I) 35) **trains.com**
Covers trains both big and small, including model trains, railroads, rail travel and trains for kids...
<http://www.trains.com/> (looksmart)

[Preview Order](#)

Internet Corporation. Phone: 1-631-757-1600 · E-Mail: gnoma@gnome.com

Current Group: I									
webcrawler1	altavista2	lycos3	google4	excite5	barnesandnoble6	looksmart7	hotbot8	borders9	amazon10
cars	boats	cars	airplanes	cars	trains	trains	cars	trains	trains
Go to page: 1 2 3 4 5 6 7 8									
Search Display (Interleaved or separately by search engine):									
Interleave Combined \$[a-z] Combine \$[z-a] Separate Separate \$[a-z] Separate \$[z-a]									
Description or List (Site descriptions or lists): List									

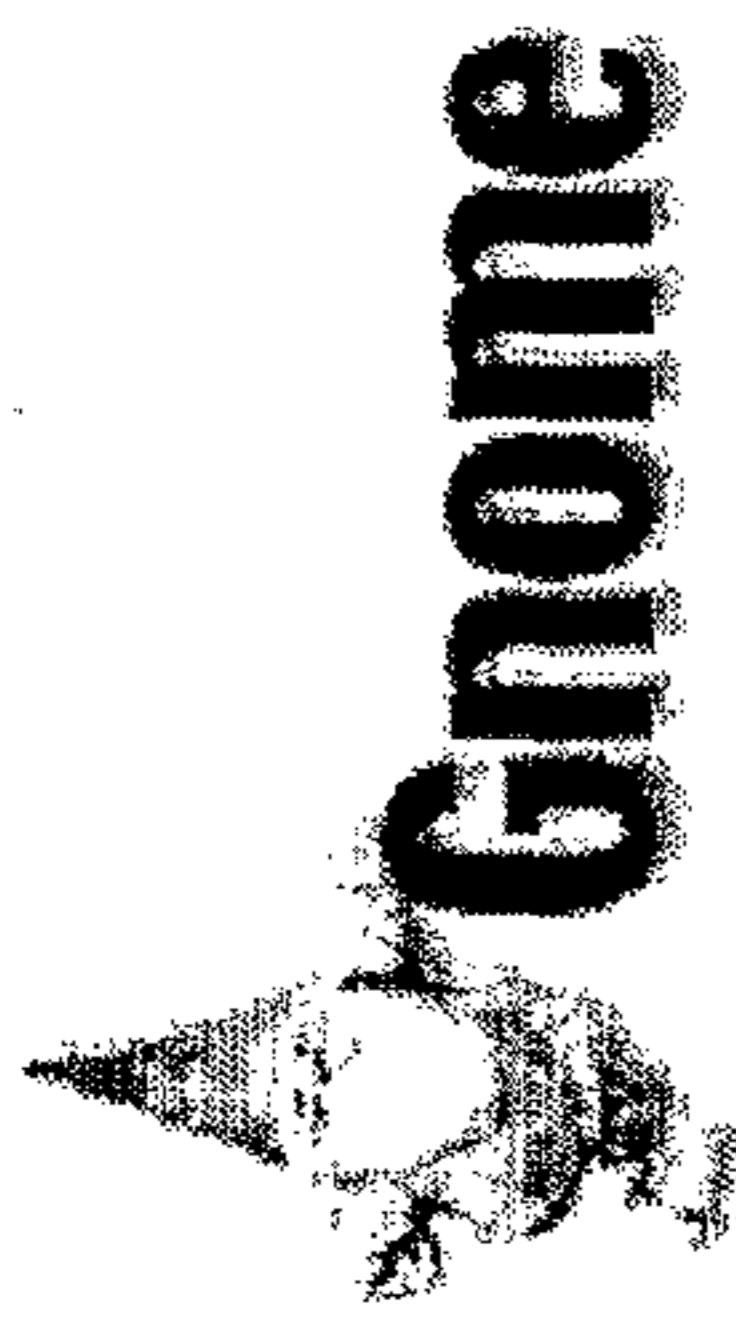

Gnome Prefers Inter-net.com

Free Stuff
Contests, Cool Sites, Shopping

Discovery
Disney, Warner, ABC, Universal, CBS, NBC

Hot Wired
E!Online, Rtdidder

TV Guide
Reel.com, Music Blvd, RealAudio, AudioNet

BuyerSellers
Ebay, DrugStore, ShopNow, Vitamin

Inter-net2
eToys, KBkids, Pets, ToysRus, PetSmart

Family
BlueMount, Women, Village, Epicurious

CitySearch
555-1212, Fodor's, Travelocity

StockMaster
CNNfn, Bloomberg, DowJones, Quote

Flowers for your Valentine
itca.com
NOW easy ordering at
Netscape
Netcenter
Click Here...

netMarket Auction VCR Spectacular
Bids start at
Click Now!

Weather
Intellicast, MapQuest

CNN
NYtimes, WSJournal, USAtoday, ABCnews, Moreover.com

ESPN
SportsLine, NFL, NBA, SmallWorld, NHL

Search your favorite search engines* (Perform Several Searches at the Same Time)
* Multiple simultaneous same and/or different searches of the same and/or different sites
* Only 1 entry required or make different entries above and/or at bottom (specify search parameters below)

Search Engine Results: URL's per Search Engine: URL Details:

Timeout (seconds) per Search Engine: Searches per Group: Page: Group:

Search'em All

WebCrawler:

Autos
Buy, Cars, Racing

Business
Investments, Funds, Companies, Industry

Careers
Jobs, Universities, Education

Entertainment
Movies, Music, TV, Games, Chat

Fashion
Designers, Style, Models

Health
Drugs, Diseases, News

Homes
Food, Wine, Gardening

Issues
Government, Politics, Taxes, Editorials

People
Relationships, Dating, Psychology

Society
Philosophy, Economics, Religion, Sociology

Sports
Baseball, Basketball, Football, Hockey

Technology
Computers, Environment, Engineering, Internet

Travel
Maps, Vacations, Fares

Top Stories
US concerns give pause for thought in Europe...
Death Toll in El Salvador Rises to 92...
Palestinians condemn war crime...
Colombias Pastrana to Meet with Bush on Drug War...
Earthquake rattles El Salvador, killing two...

LookSmart

Internet Corporation
Phone: 1-631-757-1600 • E-Mail: inter-net@inter-net.com

FIG. 68



Search4 It: Search your favorite search engines, all at the same time*
* Only 1 entry required

Webcrawler, Altavista, Lycos, Infoseek, Excite, Yahoo, LookSmart, HotBot, Dejanews

Search

Search4 it: multiple simultaneous searches

- Autos**
Buy, Cars, Racing
- Business**
Investments, Funds, Companies, Industry
- Careers**
Jobs, Universities, Education
- Entertainment**
Movies, Music, TV, Games, Chat
- Fashion**
Designers, Style, Models
- Health**
Drugs, Diseases, News
- Homes**
Food, Wine, Gardening
- Issues**
Government, Politics, Taxes, Editorials
- People**
Relationships, Dating, Psychology
- Society**
Philosophy, Economics, Religion, Sociology
- Sports**
Baseball, Basketball, Football, Hockey
- Technology**
Computers, Environment, Engineering, Internet
- Travel**
Maps, Vacations, Fares

Discovery
Disney, Warner, ABC, Universal, CBS, NBC

Hot Wired
EOnline, Riddler

TV Guide
Reel.com, MusicBlvd, RealAudio, AudioNet

BuyerSellers
Ebay, DrugStore, BlueMount, Women, eToys, KBkids, Pets

Weather
Intellicast, MapQuest

CitySearch
555-1212, Travelocity, Fodor's, LeisurePlan

ESPN
SportsLine, NFL, NBA, SmallWorld, NHL

CNN
NYTimes, WSJournal, USAtoday, ABCnews

StockMaster
CNNin, Bloomberg, DowJones, Quote

Flowers for your Valentine
Valentine  rd.com
NOW easy ordering at **Netscape Netcenter**
Click Here...

netMarket Auction VCR Spectacular
Bids start at \$1
Click Now!

February 6, 1998
ABC NEWS Headlines
U.S. Presence Growing in Iraq

Look4ItHere
Div. of Internet Corporation

Visit Look4ItHere

News **Weather** **Cool Sites** **Shopping**
Contests **Horoscopes** **Classified**

Phone: 1-631-757-1600 • E-Mail: look4ithere@look4ithere.com
Internet Corporation

FIG. 69



Free Stuff
Contests, Cool Sites, Shopping

Discovery
Disney, Warner, ABC, Universal, CBS, NBC

Hot Wired
E!Online, Riddler

TV Guide
Reel.com, MusicBlvd

Ebay
eToys, KBkids, Pets

Family
BlueMount, Women

Weather
Intellcast, MapQuest

CitySearch
555-1212, Fodor's, Travelocity

StockMaster
CNNfm, Bloomberg, DowJones, Quote

CHOOSE YOUR NEXT CAR:

Isuzu Hombre
 Cadillac Catera
 Pontiac Sunfire

Car shopping made easy. 

Search:

Flowers for your Valentine
fcd.com
NOW easy ordering at
Metscape
Netcenter
Click Here...

netMarket Auction
VCR Spectacular
Bids start at
Click Now!

CNN
NYTimes, WSJournal, USAtoday, ABCnews

ESPN
SportsLine, NFL, NBA, SmallWorld, NHL

Top Stories
Civilian sat at controls of sub during collision...
Powerful quake hits Indonesia...
US concerns give pause for thought in Europe...
Death Toll in El Salvador Rises to 92...
Palestinians condemn war crime...

Society
Sociology, Economy, Philosophy

Sports
Baseball, Basketball, Football, Hockey

Technology
Computers, Internet, Environment, Eng'g

Travel
Maps, Vacations, Fares

Fashion
Design, Models

Health
Care, Drugs, News

Homes
Food, Wine, Garden

Issues
Gov't, Politics

People
Psychology, Dating, Relationships

Autos
Buy, Cars, Racing

Business
Investments, Funds, Industry

Careers
Jobs, Universities, Education

Entertainment
Movies, Music, TV, Games, Chat

Internet Phone: 1-631-757-1600 · E-Mail: gnome@gnome.com · Internet Corporation.

FIG. 70

