



US00D711857S

(12) **United States Design Patent**
Burgett et al.

(10) **Patent No.:** **US D711,857 S**

(45) **Date of Patent:** **** Aug. 26, 2014**

- (54) **EARPHONE**
- (71) Applicants: **Seth D Burgett**, Glen Carbon, IL (US);
Effrosini A. Karayiannis, Saint Louis,
MO (US); **Aaron Gorga**, Saint Louis,
MO (US)
- (72) Inventors: **Seth D Burgett**, Glen Carbon, IL (US);
Effrosini A. Karayiannis, Saint Louis,
MO (US); **Aaron Gorga**, Saint Louis,
MO (US)
- (73) Assignee: **Verto Medical Solutions, LLC**, St.
Louis, MO (US)

D531,169	S	*	10/2006	Tokioka et al.	D14/223
D554,109	S	*	10/2007	Ledbetter et al.	D14/223
D555,152	S	*	11/2007	Wang	D14/223
D566,687	S	*	4/2008	Duarte et al.	D14/205
D566,741	S	*	4/2008	Matsuda	D16/202
D568,291	S	*	5/2008	Andre et al.	D14/205
D589,491	S	*	3/2009	Andre et al.	D14/205
D593,537	S	*	6/2009	Arimoto	D14/205
D626,117	S	*	10/2010	Lowry	D14/223
D641,010	S	*	7/2011	Kwon	D14/223
D656,129	S		3/2012	Kelly et al.		
D656,481	S	*	3/2012	McManigal	D14/205
D688,650	S	*	8/2013	Chen	D14/223
8,515,115	B2		8/2013	Kelly et al.		
D695,719	S	*	12/2013	Burgett et al.	D14/223
D699,213	S	*	2/2014	Burgett et al.	D14/205
2013/0216087	A1		8/2013	Macdonald		

(**) Term: **14 Years**

(21) Appl. No.: **29/459,884**

(22) Filed: **Jul. 3, 2013**

(51) **LOC (10) Cl.** **14-01**

(52) **U.S. Cl.**
USPC **D14/223**

(58) **Field of Classification Search**
USPC D14/205, 206, 223; 181/129, 130, 135;
379/420.01, 420.02, 420.03, 430, 431;
381/380, 381; 455/90.3, 575.1

See application file for complete search history.

(56) **References Cited**

U.S. PATENT DOCUMENTS

4,646,872	A	*	3/1987	Kamon et al.	181/129
4,965,838	A	*	10/1990	Kamon et al.	381/380
D318,473	S	*	7/1991	Miyashita et al.	D14/223
D337,118	S	*	7/1993	Seikita	D14/223
D337,589	S	*	7/1993	Wada	D14/223
D340,932	S	*	11/1993	Yan	D14/249
5,363,444	A	*	11/1994	Norris	379/430
5,410,608	A	*	4/1995	Lucey et al.	381/360
D430,139	S	*	8/2000	Peters et al.	D14/205
6,411,722	B1	*	6/2002	Wolf	381/371
D463,790	S	*	10/2002	Beraut et al.	D14/223
6,668,064	B1	*	12/2003	Lin	381/380
D499,397	S	*	12/2004	Hlas et al.	D14/223
D523,846	S	*	6/2006	Lee	D14/205

OTHER PUBLICATIONS

Burgett, Seth D. et al; Design U.S. Appl. No. 29/435,917, "Behind The Ear Earphone", filed Oct. 30, 2012.

Burgett, Seth D. et al; Design U.S. Appl. No. 29/435,920, "Behind The Ear Earphone With Enhancer", filed Jan. 12, 2013.

* cited by examiner

Primary Examiner — Paula Greene

(74) *Attorney, Agent, or Firm* — Harness, Dickey & Pierce, P.L.C.

(57) **CLAIM**

The ornamental design for an earphone, as shown and described.

DESCRIPTION

FIG. 1 is a perspective view of an earphone showing my new design;

FIG. 2 is a front elevation view thereof;

FIG. 3 is a rear elevation view thereof;

FIG. 4 is a right side elevation view thereof;

FIG. 5 is a left side elevation view thereof;

FIG. 6 is a top plan view thereof; and,

FIG. 7 is a bottom plan view thereof.

The dashed lines in the drawings are for illustrative purposes only and form no part of the claimed design.

1 Claim, 4 Drawing Sheets

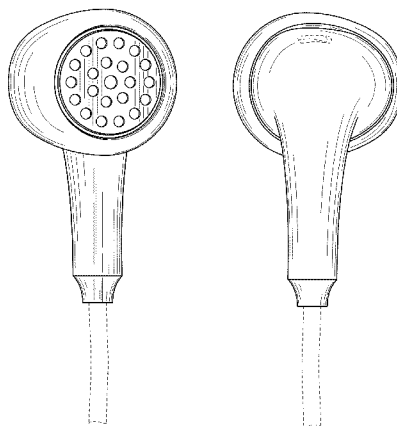

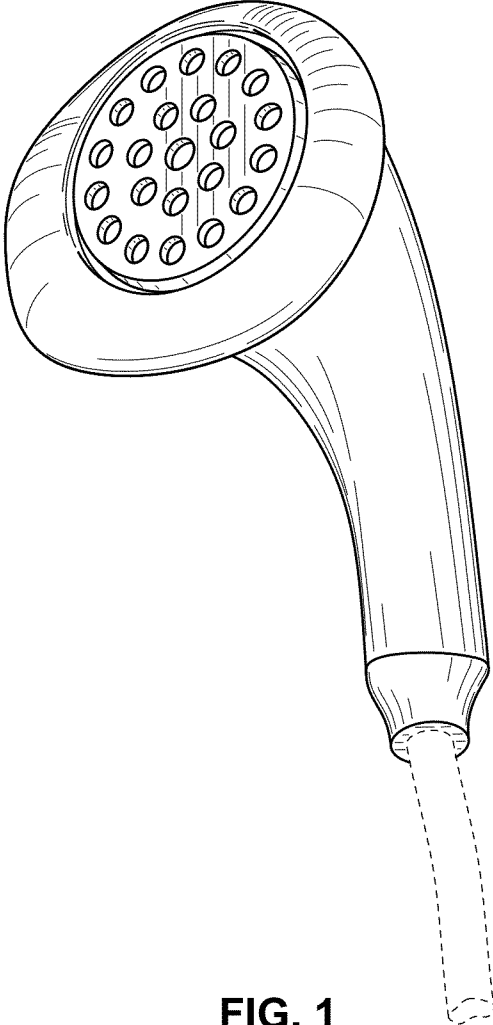

FIG. 1

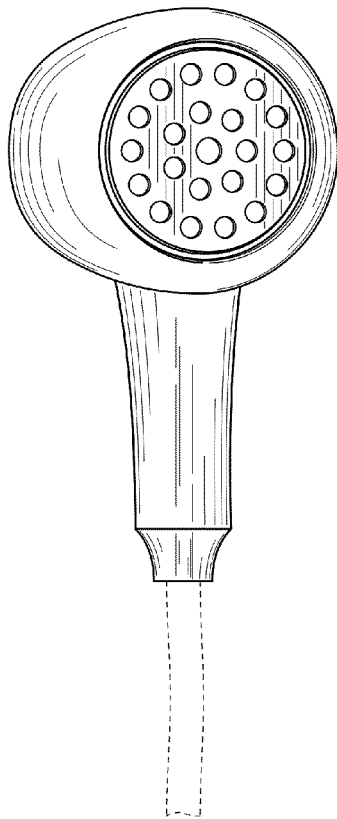

FIG. 2

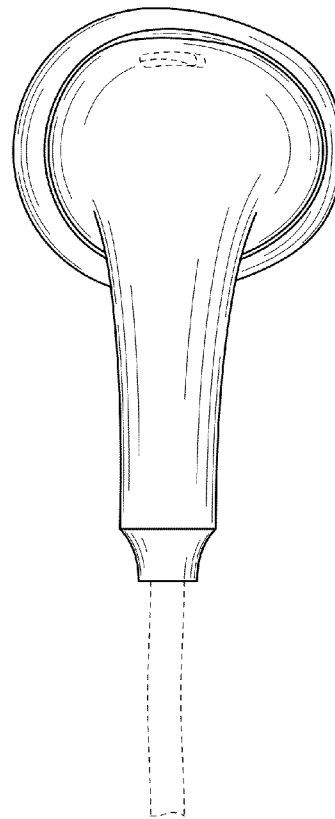

FIG. 3

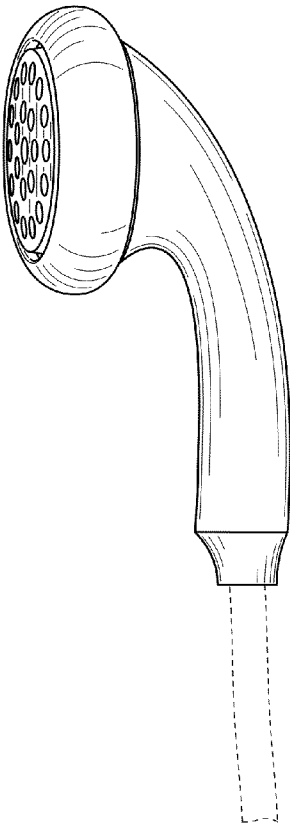

FIG. 4

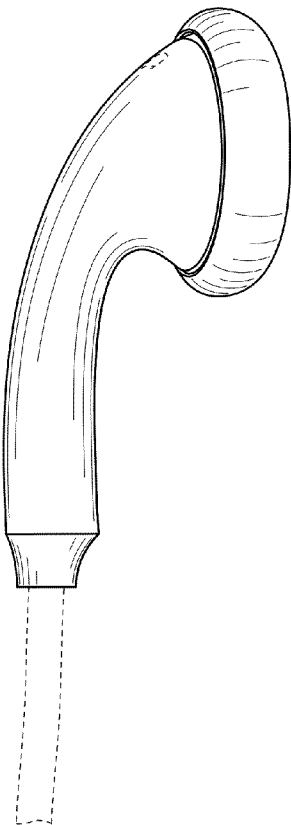

FIG. 5

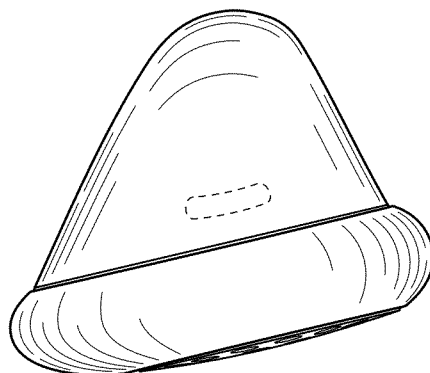

FIG. 6

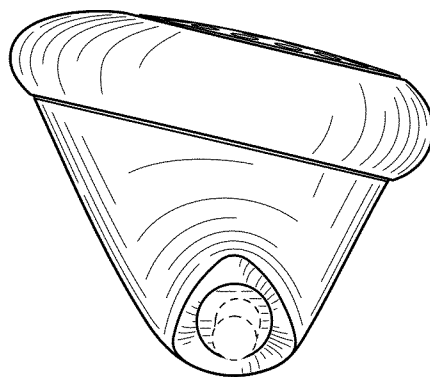

FIG. 7