



US00D356166S

United States Patent [19]

[11] Patent Number: **Des. 356,166**

Spiller

[45] Date of Patent: **** Mar. 7, 1995**

[54] **COMBINED LOCKING BRACKET AND PIN FOR A LADDER**

Attorney, Agent, or Firm—Kelly, Bauersfeld & Lowry

[76] Inventor: **David V. Spiller**, 3541 Loadstone Dr., Sherman Oaks, Calif. 91403

[57] **CLAIM**

The ornamental design for a combined locking bracket and pin for a ladder, as shown and described.

[**] Term: **14 Years**

DESCRIPTION

[21] Appl. No.: **16,730**

[22] Filed: **Dec. 22, 1993**

[52] U.S. Cl. **D25/68; D8/349**

[58] Field of Search **D8/349; 182/127, 107, 182/8, 97, 229, 206; 248/210; D25/62, 68**

FIG. 1 is a perspective view showing the top, right and front sides of a combined locking bracket and pin for a ladder embodying my new design, the dotted line depiction of a truck and rack being for illustrative purposes only and forming no part of the claimed design; FIG. 2 is an enlarged rear elevational view thereof; FIG. 3 is a left side elevational view thereof; FIG. 4 is a front elevational view thereof; FIG. 5 is a right side elevational view thereof; FIG. 6 is a top plan view thereof; FIG. 7 is a bottom plan view thereof; and, FIG. 8 is a reduced perspective view of the locking bracket and pin for a ladder, the dotted line depiction showing the placement of the pin in the bracket.

[56] **References Cited**

U.S. PATENT DOCUMENTS

- 4,363,378 12/1982 Williams et al. 182/107
- 4,643,275 2/1987 LeBlanc 182/93

Primary Examiner—Wallace R. Burke

Assistant Examiner—H. Baynham

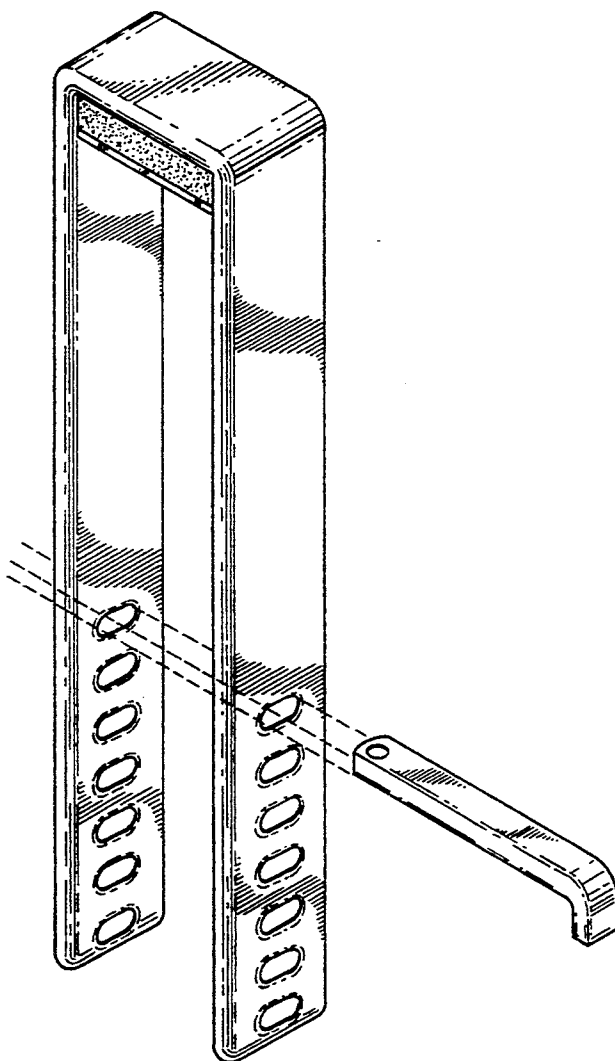

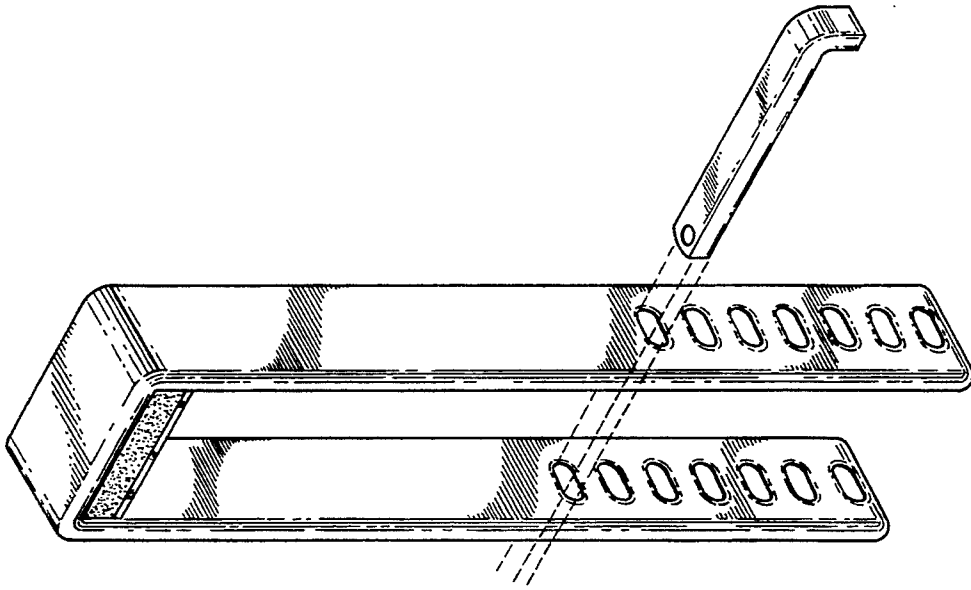

FIG. 8

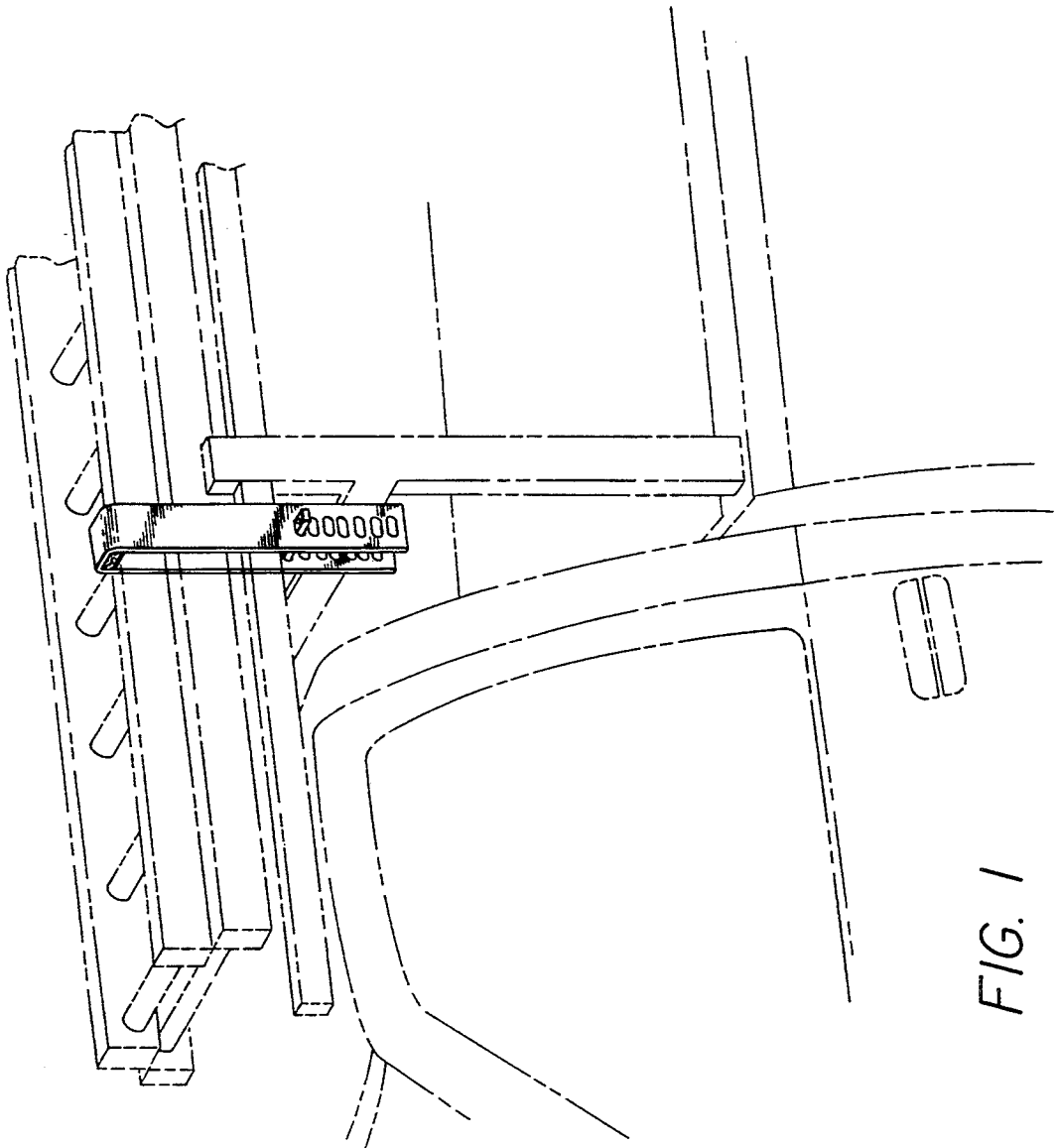

FIG. 1

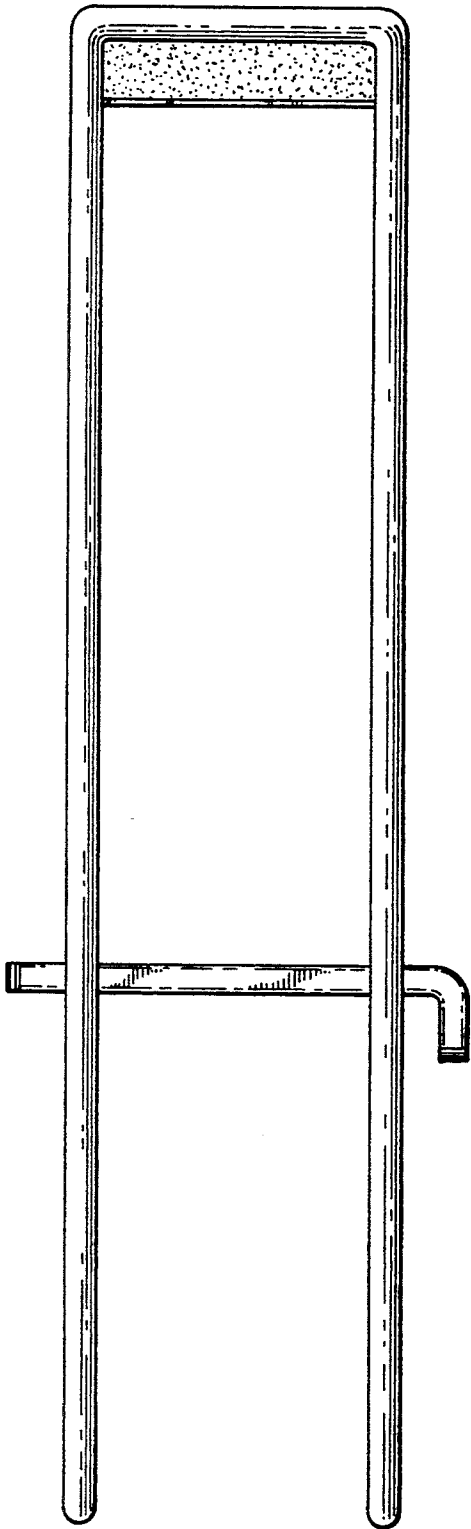

FIG. 2

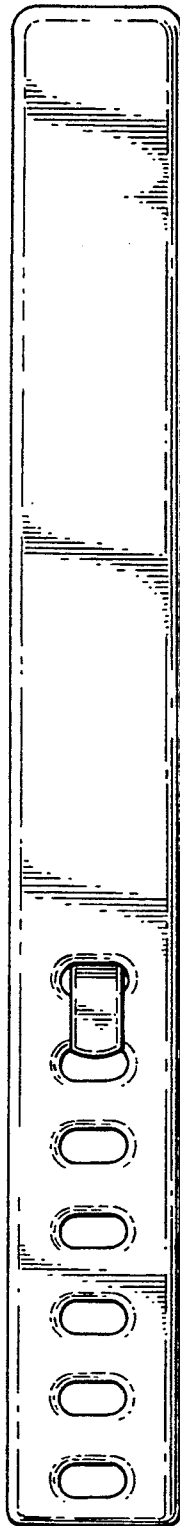

FIG. 3

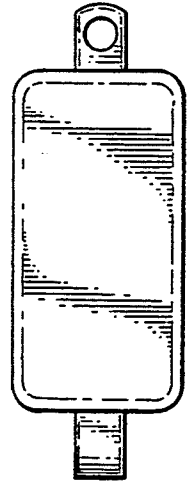

FIG. 6

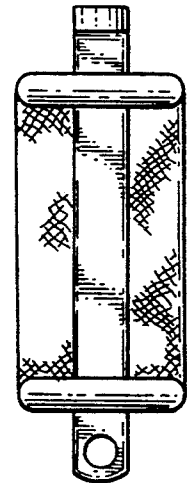

FIG. 7

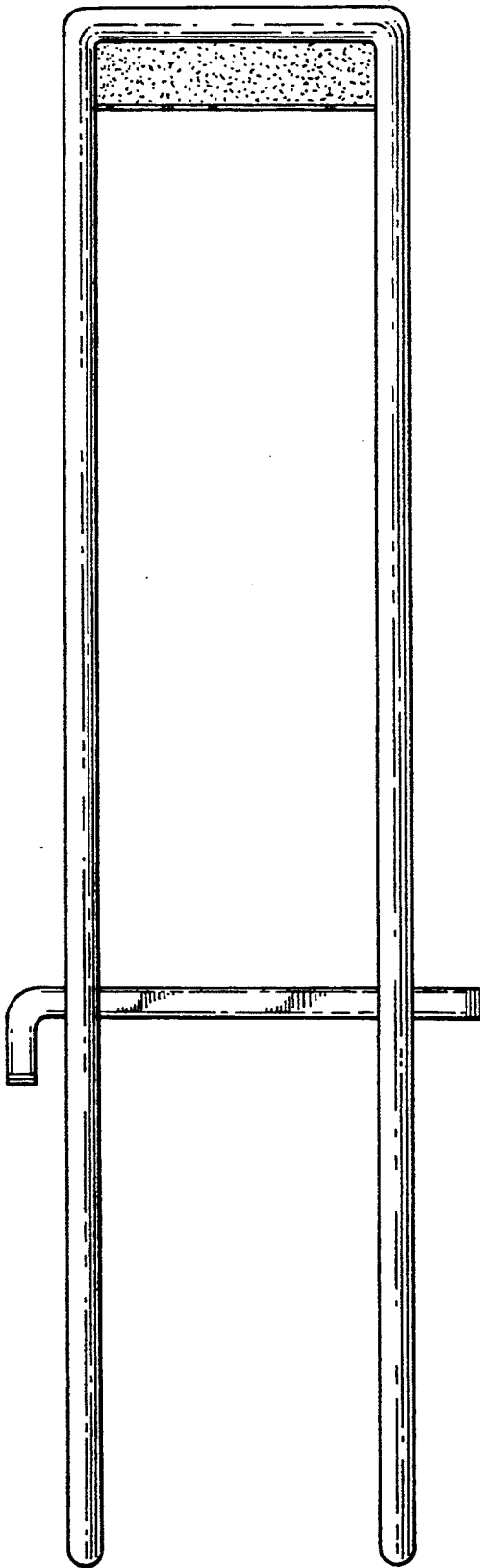

FIG. 4

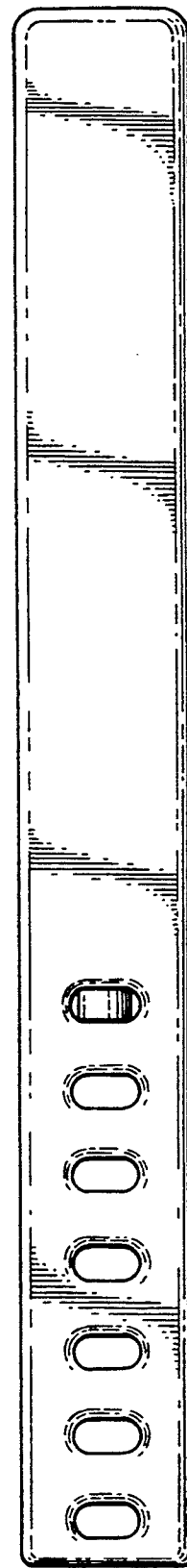

FIG. 5