

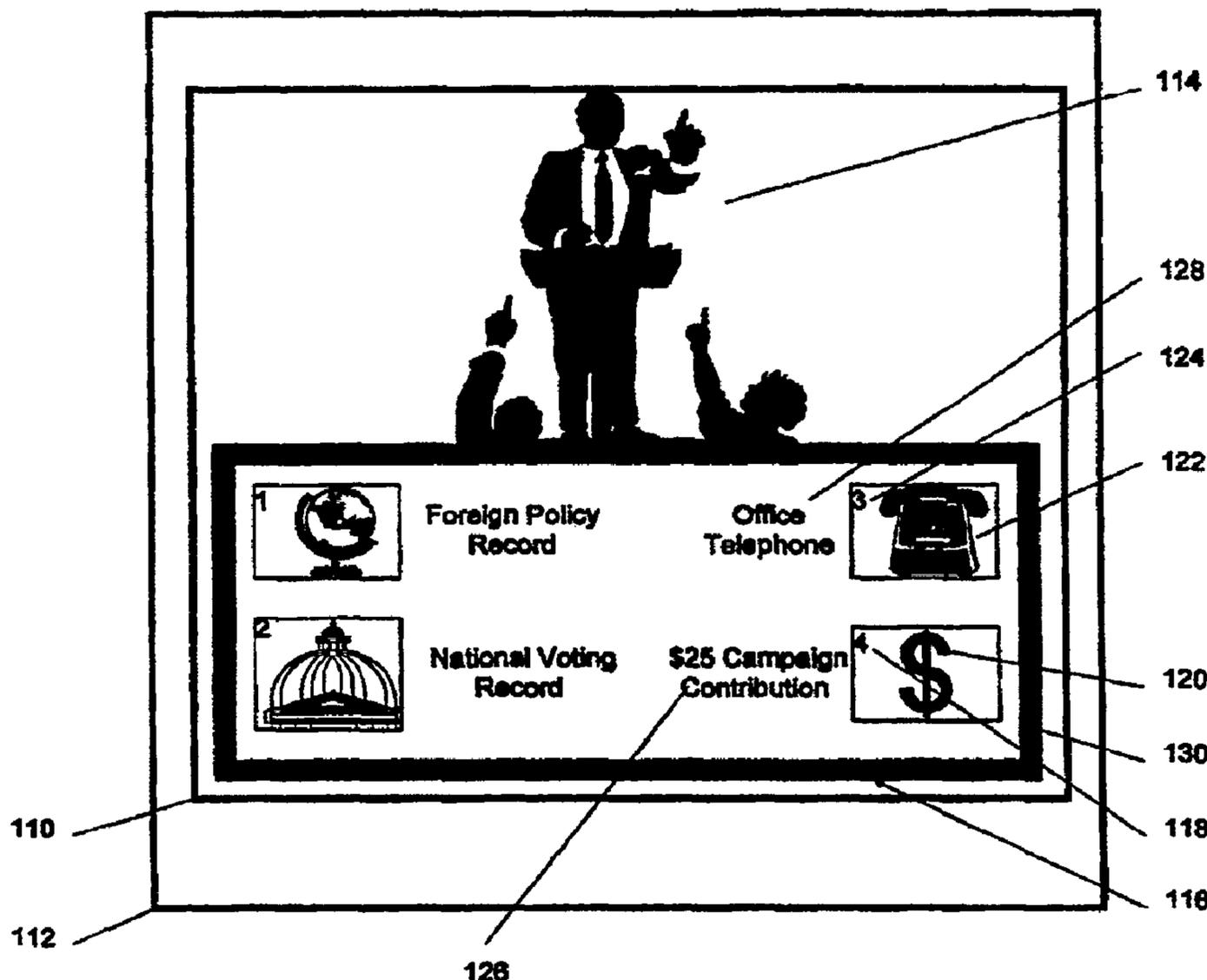

(86) Date de dépôt PCT/PCT Filing Date: 1996/04/09  
 (87) Date publication PCT/PCT Publication Date: 1996/10/31  
 (45) Date de délivrance/Issue Date: 2002/07/16  
 (85) Entrée phase nationale/National Entry: 1997/10/20  
 (86) N° demande PCT/PCT Application No.: US 1996/004819  
 (87) N° publication PCT/PCT Publication No.: 1996/034466  
 (30) Priorité/Priority: 1995/04/26 (08/429107) US

(51) Cl.Int.<sup>6</sup>/Int.Cl.<sup>6</sup> H04N 7/173  
 (72) Inventeurs/Inventors:  
 DOUGHERTY, Brian P., US;  
 DEL SESTO, Eric E., US  
 (73) Propriétaire/Owner:  
 WINK COMMUNICATIONS, INC., US  
 (74) Agent: SIM & MCBURNEY

(54) Titre : SYSTEME COMPACT D'INFORMATION GRAPHIQUE INTERACTIVE PAR TELEDIFFUSION  
 (54) Title: COMPACT GRAPHICAL INTERACTIVE BROADCAST INFORMATION SYSTEM



(57) Abrégé/Abstract:

A method and apparatus allows an information provider to broadcast a graphical interactive information system application to a user even using a low-bandwidth transport such as the VBI. A compact protocol encapsulates graphical information using definitions of graphical objects and resources. A scripting and command language is also highly compact. A reception component receives the compact protocol and displays and operates a complete graphical interactive information system application.



**PCT**

WORLD INTELLECTUAL PROPERTY ORGANIZATION  
International Bureau

INTERNATIONAL APPLICATION PUBLISHED UNDER THE PATENT COOPERATION TREATY (PCT)

<p>(51) International Patent Classification <sup>6</sup> : <b>H04H 1/00</b></p>	<p><b>A1</b></p>	<p>(11) International Publication Number: <b>WO 96/34466</b> (43) International Publication Date: 31 October 1996 (31.10.96)</p>
<p>(21) International Application Number: PCT/US96/04819 (22) International Filing Date: 9 April 1996 (09.04.96) (30) Priority Data: 08/429,107 26 April 1995 (26.04.95) US (71) Applicant: WINK COMMUNICATIONS, INC. [US/US]; 1001 Marina Village Parkway, Alameda, CA 94501 (US). (72) Inventors: DOUGHERTY, Brian, P.; 122 Lawrence Road, Alameda, CA 94502 (US). DEL SESTO, Eric, E.; 1082 Armitage Street, Alameda, CA 94502 (US). (74) Agents: GOTLIEB, Charles, E. et al.; Fenwick &amp; West L.L.P., Suite 600, Two Palo Alto Square, Palo Alto, CA 94306 (US).</p>	<p>(81) Designated States: AL, AM, AT, AU, AZ, BB, BG, BR, BY, CA, CH, CN, CZ, DE, DK, EE, ES, FI, GB, GE, HU, IS, JP, KE, KG, KP, KR, KZ, LK, LR, LS, LT, LU, LV, MD, MG, MK, MN, MW, MX, NO, NZ, PL, PT, RO, RU, SD, SE, SG, SI, SK, TJ, TM, TR, TT, UA, UG, UZ, VN, ARIPO patent (KE, LS, MW, SD, SZ, UG), Eurasian patent (AM, AZ, BY, KG, KZ, MD, RU, TJ, TM), European patent (AT, BE, CH, DE, DK, ES, FI, FR, GB, GR, IE, IT, LU, MC, NL, PT, SE), OAPI patent (BF, BJ, CF, CG, CI, CM, GA, GN, ML, MR, NE, SN, TD, TG).</p> <p><b>Published</b> <i>With international search report. Before the expiration of the time limit for amending the claims and to be republished in the event of the receipt of amendments.</i></p>	

(54) Title: COMPACT GRAPHICAL INTERACTIVE BROADCAST INFORMATION SYSTEM

(57) Abstract

A method and apparatus allows an information provider to broadcast a graphical interactive information system application to a user even using a low-bandwidth transport such as the VBI. A compact protocol encapsulates graphical information using definitions of graphical objects and resources. A scripting and command language is also highly compact. A reception component receives the compact protocol and displays and operates a complete graphical interactive information system application.

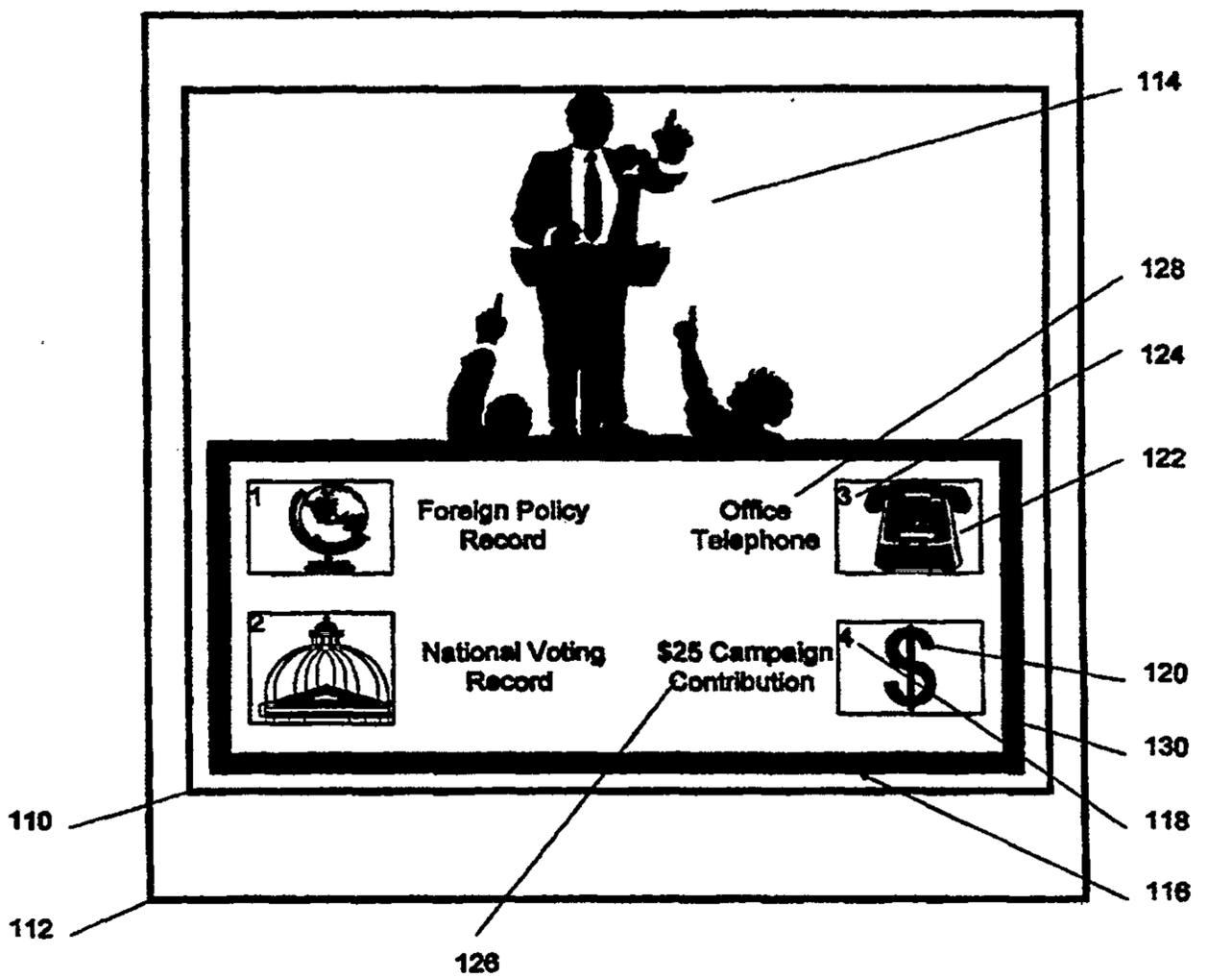

**COMPACT GRAPHICAL INTERACTIVE BROADCAST INFORMATION SYSTEM**Field of Invention

The present invention relates to broadcast and receiving systems, and more  
5 specifically, to interactive broadcast and receiving systems.

Background of Invention

Interactive information systems allow an information provider to broadcast  
information to a user, and in some cases allow a user to send a response to a response  
collector. The user may receive the information on a wide variety of devices, such as a pager,  
10 cellular telephone, personal digital assistant or a television. An interactive information system  
on which the user receives the information using a television is called an interactive  
television system.

An interactive television system can enhance the television viewing experience. An  
interactive television system allows an information provider to broadcast information to users  
15 for viewing on their television systems, and defines how the user is allowed to control the  
time, order, type of information displayed, or other aspects. An interactive television system  
may allow the user to send to a response collector responses to the information received, or  
new information.

Some interactive television systems provide a textual user interface, displaying  
20 formatted textual information to the user. However unlike graphical interactive information  
systems, text-based systems do not allow the information provider to control and present a  
wide variety of graphical information and formatting that are commonly used with graphical  
user interfaces. A graphical interactive information system uses a graphical user interface to  
display a variety of graphical information and allows the user to control the operation of the  
25 system based upon the graphical display. Text-based systems are more difficult to use and  
limit the appeal of the interactive television system in much the same way that text-based  
computer operating systems limited the appeal of computer systems prior to the introduction  
of graphical user interfaces.

One such attempt (Lappington, U.S. Pat. No. 5,343,239) inserts textual data in a  
30 binary format into unused lines in the Vertical Blanking Interval, or VBI, of the conventional  
television transmission for decoding by a set-top device and transmission to, and display on, a  
handheld remote control device. The VBI is a portion of the television picture which is  
broadcast, but not typically seen by the television viewer, and readily allows for insertion of  
data, such as closed captioning text. However, the limited data capacity of the VBI has thus  
35 far prevented the use of

graphical user interfaces, because the VBI does not have the data capacity required to send the large amount of data to date required for a graphical user interface. For example, Lappington does not disclose a graphical user interface.

5 One interactive television system (Fascenda et al., U.S. Pat. No. 4,592,546) does not use the VBI at all, instead sending information to the user via an FM subcarrier channel. Such a system has the drawback of requiring a large initial user investment in equipment required to receive the information. Additionally, Fascenda does not suggest the transmission of graphical user interface information.

10 To circumvent the limited capacity of the available data transport mechanisms, a functionally-limited graphical-like interactive television system has been developed (Young, U.S. Pat. No. 5,353,121). Young suggests a system which allows an information provider to send a sequence of text over the VBI to a set of predefined overlays. The result appears to be a more graphical display than Lappington, because boxes surround each section of the text. Although Young does not disclose how the size of the box is determined, which party controls  
15 the size of the box, or how the box is displayed on the screen, nevertheless, the mere control of the width of a box surrounding text, without more, is not a graphical user interface of the type set forth in the illustrated embodiments of the present invention. In addition, Young does not allow the information provider to design new overlays, and thus is limited to the overlays which have been predefined. This restriction limits the type and format of the data which can be displayed to  
20 data fitting into one of the predefined overlays existing in the user-device used to render the display.

None of these devices allows an information provider to broadcast a true graphical user interface to an interactive information system. Nor do these devices solve the additional problems inherent in the reception and display of a graphical user interface.

25 One inherent problem is the reluctance of many users to significantly invest in separate reception or display equipment required to display and operate a graphical interactive information system. For example, many potential users of a graphical interactive television system will not pay the cost of receiving the graphical interactive information over an FM channel because of the cost of the additional tuner equipment required by such an approach.  
30 Conventional set top cable television decoder boxes can provide a desirable reception platform for interactive television systems because they are relatively cheap, contain much of the necessary interface and reception equipment, and are accepted in most homes. However, the use of such devices would be acceptable if only inexpensive, compact modifications were required to display and operate a graphical interactive information system.

35 Another problem is the lack of standards among reception and display equipment vendors. For example, conventional set-top cable decoder boxes might be used as a platform as described above. However, a variety of set-top equipment exists yielding a variety of capabilities. Each vendor promotes a system that will use the vendor's equipment capabilities to the fullest extent possible. Vendors typically would not accept a system which was designed

only for the most basic equipment, nor would they likely accept a system which only operated with the most feature-rich equipment.

Another problem is the requirement for interactive television systems that such a system work rapidly enough to operate in conjunction with existing broadcast television shows. For example, graphical interactive television system applications which operate in conjunction with existing television game show programs must be transmitted to display the graphical user interface quickly. Furthermore, there must be a mechanism to make modifications to the user interface quickly, to allow large amounts of information to be updated rapidly.

#### Summary of Invention

10 A method and apparatus allows an information provider to send a graphical interactive information system application to a reception component for presenting the graphical interactive information system to, and allowing its operation by, the user. The information provider provides a description of the layout and the information to be displayed, and one or more definitions, commands or scripts which compactly describe one or more graphical images to be  
15 displayed, and may describe the relationships between one or more of the graphical images, are encoded in a broadcast signal. The definitions, commands and scripts are compact, requiring relatively low bandwidth. A reception component decodes the definitions, commands or scripts and generates the images for display on a display device such as a television. Thus, decoding provides a relatively large amount of graphical information from the compact definitions,  
20 commands and scripts, allowing a even presently available low bandwidth broadcast media, such as the VBI, to be used to carry complete graphical interactive information system applications for display to, and operation by, a user. Even low bandwidth broadcast media can be used to carry complete graphical interactive information system applications for display and operation rapidly enough to allow a graphical interactive information system application integrated with the  
25 content of a conventional broadcast program or advertisement to be broadcast simultaneously with the program or advertisement. Because special high-bandwidth media are not required, existing inexpensive user equipment may be inexpensively modified and used to display and operate graphical interactive information system applications. Because of the compact size of the information broadcast, the information may be stored in the reception component after  
30 reception on compact, inexpensive storage devices, helping to maintain the low cost of the user equipment.

The reception component can adapt the image based upon the capabilities of the reception component, the display device, or both, allowing reception and display on a wide variety of user equipment. Because the command decoder that adapts the image is aware of its  
35 own capabilities, adaptation information need not be broadcast, maintaining the small size of the information broadcast. Because the image is generated and adapted by the reception component, the description of the image is platform-independent, freeing the information provider of the necessity of formatting information differently for each type of reception component.

The image or sequence of images may be displayed in response to commands from the user in a manner defined by the information provider. Certain user commands may be transmitted from the user to a response collector.

In accordance with one aspect of the present invention there is provided a graphical  
5 interactive information system for broadcasting and receiving graphical interactive information system applications having a graphical user interface comprising:

a provider component for broadcasting graphical interactive information system application information, the provider component comprising:

10 a protocol generator and formatter having an input for accepting information from an information provider, for generating, formatting and presenting at an output a protocol for a graphical interactive information system application corresponding to the information input from the information provider;

a protocol inserter having a first input coupled to the protocol generator and formatter output, for inserting the protocol into a broadcast signal and presenting at an output  
15 the broadcast signal containing the inserted protocol; and

a transmitter having an input coupled to the protocol inserter output, for broadcasting the broadcast signal containing the inserted protocol; and

20 a reception component for receiving the graphical interactive information system application information broadcast, displaying the graphical interactive information system application user interface and operating the graphical interactive information system application.

In accordance with another aspect of the present invention there is provided a graphical interactive information system for broadcasting and receiving graphical interactive information system applications having a graphical user interface comprising:

25 a provider component for broadcasting graphical interactive information system application information; and

a reception component for receiving the graphical interactive information system application information broadcast, displaying the graphical interactive information system application user interface and operating the graphical interactive information system  
30 application, the reception component comprising:

a first tuner for receiving a broadcast signal and tuning at least one desired frequency at an output;

a data extractor coupled to the first tuner output for extracting a graphical interactive information system application from the desired frequency;

a microprocessor coupled to the data extractor output for controlling the operation of the reception component and interpreting interactive information system application commands and scripts;

5 a graphics display generator having a first input coupled to the microprocessor for generating at an output a graphical user interface display signal; and

a storage device coupled to the microprocessor for storing interactive information system application information.

In accordance with yet another aspect of the present invention there is provided a system including a plurality of reception components having defined display capabilities, at least two of the plurality of reception components having different display capabilities, a method of providing a graphical interactive information application for display to, and control by, a user, comprising the steps of:

broadcasting at least one graphical object definition record comprising hint information describing optional image characteristics of a graphical object;

15 receiving the broadcast graphical object definition record and hint information at each of the plurality of reception components; and

creating different graphical interactive information displays on ones of the plurality of reception components having different display capabilities based upon the broadcast graphical object definition record and using the hint information to selectively display the graphical object with the optional image characteristics supported by the capabilities of the reception components.

In accordance with yet another aspect of the present invention there is provided a system including first and second reception components having different display capabilities, a method of decoding a broadcast signal comprising the steps of:

25 receiving the broadcast signal at the first and second reception components;

extracting at the first and second reception components an executable graphical interactive information system application including at least one image and hint information describing optional characteristics of the image;

30 executing the graphical interactive information system application on the first reception component to generate the at least one image for display on a first display device coupled to the first reception component;

executing the graphical interactive information system application on the second reception component to generate the at least one image for display on a second display device coupled to the second reception component;

selectively adapting the generation of the at least one image to the display device of the first reception component based upon the hint information and the display capabilities of the first reception component; and

5 selectively adapting the generation of the at least one image to the display device of the second reception component based upon the hint information and the display capabilities of the second reception component, wherein the at least one image displayed on the first display device is different than the at least one image displayed on the second display device.

In accordance with yet another aspect of the present invention there is provided a method for providing a graphical interactive information application describing at least one  
10 image to a plurality of reception components having defined display capabilities, at least two of the plurality of reception components having different display capabilities, the method comprising the step of:

broadcasting at the least one graphical object definition record describing at least one image and comprising hint information describing optional characteristics of the at least one  
15 image to the plurality of reception components;

wherein ones of the plurality of reception components having different display capabilities create different graphical interactive information displays based upon the broadcast graphical object definition record and using the hint information to selectively display optional characteristics of the at least one image supported by the reception  
20 components.

In accordance with yet another aspect of the present invention there is provided in a system including a plurality of reception components, each reception component having display capabilities, a method of providing a graphical interactive application comprising:

receiving the broadcast signal at a first reception component, the broadcast signal  
25 including a graphical interactive application containing at least one graphical object definition record comprising hint information describing optional image characteristics of a graphical object;

extracting the graphical interactive application from the broadcast signal at the first reception component; and

30 executing the graphical interactive application on the first reception component to generate at least one image for display on a display device coupled to the first reception component, by using the hint information of the graphical object definition record to selectively display the graphical object in the at least one image with the optional image characteristics supported by the capabilities of the reception component.

In accordance with yet another aspect of the present invention there is provided a method of executing a broadcast graphical interactive application by a reception component, the method comprising:

storing a plurality of standardized graphical objects in the reception component;

5 receiving in the reception component via a broadcast signal, an application header record for the graphical application describing characteristics of the graphical application including an application identifier and data descriptive of a number of records in the graphical application;

10 receiving in the reception component via the broadcast signal graphical object definition records and script records of the graphical application in any order after receiving an application header record, the graphical object definition records describing graphic objects to be displayed using the standardized graphical objects stored in the reception component, the script records describing steps to be performed by the graphical application;

determining that all records of the graphical application have been received; and

15 responsive to all records of the graphical application having been received, executing the graphical application, including selectively displaying graphical objects using the stored graphical objects and the graphical object definition records, and executing the steps in the script records.

### 20 A Brief Description of the Drawings

Embodiments of the present invention will now be described more fully with reference to the accompanying drawings in which:

Figure 1 is an illustration of a conventional television screen displaying a conventional television program with a graphical interactive information system application displayed according to one embodiment of the present invention.

Figure 2A is a block schematic diagram of a provider component apparatus according to one embodiment of the present invention.

Figure 2B is a block schematic diagram of a reception component apparatus according to one embodiment of the present invention.

30 Figure 2C is a block schematic diagram of a provider component apparatus according to an alternate embodiment of the present invention.

Figure 2D is a block diagram of developers and information providers according to one embodiment of the present invention.

Figure 3 is a block schematic diagram of user equipment according to one embodiment of the present invention.

Figure 4 is a flowchart illustrating a method of one embodiment of the present invention.

5 Figure 5 is a block diagram representing a format of an application header record according to one embodiment of the present invention.

Figure 6 is a block diagram representing a format of a form definition record according to one embodiment of the present invention.

10 Figure 7A is an illustration of a conventional television display with a form according to one embodiment of the present invention.

Figure 7B is a block diagram representing a format of a form object definition record according to one embodiment of the present invention.

Figure 8 is a block diagram representing a format of a button object definition record according to one embodiment of the present invention.

15 Figure 9 is a block diagram representing a format of a text object definition record according to one embodiment of the present invention.

Figure 10 is a block diagram representing a format of a bitmap object definition record according to one embodiment of the present invention.

20 Figure 11 is a block diagram representing a format of a list object definition record according to one embodiment of the present invention.

Figure 12 is a block diagram representing a format of a timer object definition record according to one embodiment of the present invention.

Figure 13 is a block diagram representing a format of a picture object definition record according to one embodiment of the present invention.

Figure 14A is a block diagram representing a format of a resource definition record according to one embodiment of the present invention.

Figure 14B is a block diagram representing a format of a text resource according to one embodiment of the present invention.

5 Figure 14C is a block diagram representing a format of a bitmap resource according to one embodiment of the present invention.

Figure 14D is a block diagram representing a format of a picture resource according to one embodiment of the present invention.

10 Figure 14E is a block diagram representing a format of a picture resource element according to one embodiment of the present invention.

Figure 14F is a block diagram representing a format of a resource list according to one embodiment of the present invention.

Figure 14G is a block diagram representing a format of a resource list element according to one embodiment of the present invention.

15 Figure 15 is a block diagram representing a format of an update record according to one embodiment of the present invention.

Figure 16 is a block diagram representing a format of an interactive icon definition record according to one embodiment of the present invention.

20 Figure 17A is a block diagram representing a format of a script execute record according to one embodiment of the present invention.

Figure 17B is a block diagram representing a format of a script resource according to one embodiment of the present invention.

Figure 18A is a flowchart illustrating a method of broadcasting a broadcaster information table according to the present invention.

25 Figure 18B is a flowchart illustrating a method of Receiving a broadcaster information table according to the present invention.

Figure 18C is a flowchart illustrating a method of using a broadcaster information table according to the present invention.

30 Figure 19 is a flowchart illustrating a method of drawing a form on a display according to the present invention.

Figure 20 is a flowchart illustrating a method of drawing an object on a display according to the present invention.

Figure 21 is a flowchart illustrating a method of drawing a resource on a display according to the present invention.

35 Figure 22 is a block diagram representing a format of a response record according to one embodiment of the present invention.

Figure 23 is a block schematic diagram illustrating a response network according to one embodiment of the present invention.

Figure 24 is a flowchart illustrating a method of allowing a user to use an unsecure communication line to send confidential information to an order processor according to the present invention.

### Detailed Description of a Preferred Embodiment

#### 5        I. Example.

Referring now to Figure 1, a sample graphical interactive television system application display is shown. A display screen 110 of a conventional television 112 displays a conventional television show which contains a politician 114 giving a speech. A graphical interactive information system application form 116 having a border 130 is displayed by the graphical  
 10 interactive television system on the screen 110 of the television 112. The form 116 may contain text descriptions 126, 128 and pictures or icons 120, 122 corresponding to buttons 118, 124 to allow the user to make a selection by pressing a numeric key using a conventional television remote control device. When the user indicates a selection by pressing a remote control key corresponding to a button 118, 124, a new form may be displayed containing additional  
 15 information relating to the indicated selection. In one embodiment, one or more selections may cause the graphical interactive television system to send response information to a response collector which may or may not be the information provider. For example, button 118 can allow the user to make a \$25 campaign contribution to the candidate 114. If during the broadcast program a second candidate follows the first candidate 114, an identical form 116 may be  
 20 displayed related to information or a response collector different from that relating to the first candidate 114.

Graphical interactive information is communicated to the user by broadcasting graphical interactive information system applications. A graphical interactive information system application is a set of definitions, commands, scripts and data which may be used to produce a  
 25 graphical user interface, determine how a user may control the graphical interactive information system application and external devices and control and define response information. Graphical interactive applications may be broadcast to correspond to other information broadcast, such as in the example of Figure 1 above. When the graphical interactive application is broadcast to correspond to a broadcast program, it is called a program application. When the graphical  
 30 interactive application is broadcast to correspond to an advertisement, it is called an advertisement application. A graphical interactive application may be broadcast which does not relate to a broadcast program or advertisement, and such an application is called a graphical virtual interactive channel. For example, with a graphical interactive television system, a program listing guide or weather information may be broadcast independently of the other  
 35 broadcast programs. Because of the flexibility of the system, any form of information may be broadcast.

#### II. Hardware.

Referring now to Figures 2A and 2B, two components, a provider component 206 and a reception component 234, are used to implement a graphical interactive information system in

accordance with the present invention. The provider component 206 allows the generation and broadcast of the graphical interactive information system application, and the reception component 234 allows for the reception, decoding, control and display of the graphical interactive information system application. The present invention allows the provider component 206 to define the display and control of a graphical interactive information system application to be displayed on the reception component 234 without requiring the high bandwidth normally associated with interactive information systems which display a graphical user interface. The provider component 206 compresses the graphical interactive information system applications by isolating only the information needed to allow the reception component 234 to produce the graphical user interface and by encapsulating the remainder of the application. Because of this graphical application compression and encapsulation, high bandwidth is not required to broadcast the application. The graphical interactive information system application is broadcast to the reception component 234, which is able to reproduce a complete graphical interactive information application from the small amount of information it receives from the provider component 206 plus its own resident intelligence.

A. Provider Component.

The provider component 206 inserts and broadcasts graphical interactive information system applications onto a broadcast signal. In one embodiment, a conventional broadcast signal is provided by signal provider 208. In one embodiment, signal provider 208 is a program generator. In another embodiment, signal provider 208 is a video signal source from a live feed. In another embodiment, signal provider 208 is a video signal from a video storage device, such as a video tape recorder.

The provider component 206 also contains a graphical interactive compact protocol generator and formatter 210. A graphical interactive compact protocol generator and formatter 210 is used by an information provider to generate the interactive information system information to be broadcast. In one embodiment, the graphical interactive compact protocol generator and formatter 210 is a conventional 486 personal computer system with a stored program for operation as described below. The graphical interactive compact protocol generator and formatter 210 generates the compact protocol, described below, in response to commands provided to it by an information provider. In one embodiment, the information provider types in the compact protocol bytes which will represent the graphical user interface as described below. In another embodiment, a visual interface is used to allow a form designer to design forms and immediately see how they will appear. The graphical interactive compact protocol generator and formatter 210 translates and formats the form appearing on the computer screen of the graphical interactive compact protocol generator and formatter 210 into the compact protocol described below. In another embodiment, the graphical interactive compact protocol generator and formatter 210 receives assignment of attribute commands such as `form1.border.color = red`, and generates the proper compact protocol commands as described below.

A compact protocol inserter **212** inserts the compact protocol from the compact protocol generator **210** into the broadcast medium. The broadcast medium is the frequency spectrum used to carry the compact protocol. In one embodiment, the graphical interactive information system is a graphical interactive television system, the broadcast medium is a standard North American television signal according to NTSC standards, and the vertical blanking interval, or VBI, is used as a transport to broadcast the compact protocol. A transport is the specific portion of the broadcast medium which will carry the compact protocol.

In one embodiment, conventional methods are employed to insert data into the VBI of a conventional broadcast from a broadcast device. The North American Broadcast Teletext Standard EIA-506, OSI layers 1-4, defines the methods and protocols for sending data in one or more lines of the VBI. In one embodiment, the conventional TDS-3 Data Delivery System, available commercially from Norpak of Katana, Ontario, Canada acts as a compact protocol inserter **212** by receiving an RS-232 serial bit stream, buffering the bit stream, and inserting the bits over one or more lines of the VBI.

In one embodiment, error checking or error correcting codes such as Hamming codes are inserted with the data. In one embodiment, the compact protocol inserter **212** translates the data into a Hamming code, and in another embodiment, the compact protocol generator **210** produces Hamming coded data or adds a parity bit.

The compact protocol inserter **212** is coupled to a transmitter **214** which broadcasts the compact protocol described below. In one embodiment, the transmitter **214** is a conventional television broadcast transmitter which receives and broadcasts the signal from conventional VBI inserter **212** which includes the conventional broadcast program and advertisement output signal from program generator **208**, and the compact protocol from compact protocol generator and formatter **210**. In this fashion, graphical interactive television information may be broadcast on the same frequency with a related television program.

In another embodiment, the transmitter **214** is a conventional cable system head-end amplifier. In another embodiment, the signal provider **208** does not output a television program, and the compact protocol is broadcast without a television program.

In another embodiment, the transmitter **214** is a conventional cellular telephone transmitter. In another embodiment, transmitter **214** is a conventional pager transmitter. These embodiments allow interactive information systems to be used independently of a conventional broadcast such as a television broadcast if desired, allowing the user to access the information from a cellular telephone or cellular equipped personal digital assistant, or even a pager.

A graphical interactive television system need not use the VBI to broadcast a compact protocol for use with a television program, as a wide variety of other transports are available. Some of these transports broadcast the compact protocol separately from the television program, yet retain the ability to coordinate the graphical interactive information with a television program. In this case, transmitter **214** does not broadcast the television program, instead allowing another transmitter to broadcast the program. This allows transmitter **214** to broadcast

the compact protocol on any type of frequency. In one embodiment, the transmitter 214 is a conventional out-of-band transmitter which transmits the compact protocol on an unused portion of the television frequency spectrum. In another embodiment, the transmitter 214 is a conventional FM transmitter. Any form of broadcast, wire or cable transmitter may be used to broadcast the compact protocol.

In one embodiment, the developer of an interactive information system application may be a different person or entity from the broadcaster who broadcasts the application. Referring now to Figures 2A and 2C, one embodiment of a provider component 266 is shown. Compact protocol generator and formatter 276 is similar to compact protocol generator and formatter 210. However, the compact protocol generator and formatter 276 is not a part of the provider component 266. Instead, another party known as the developer develops the graphical interactive information system applications on the compact protocol generator and formatter 276 and provides them via diskette or modem or other communication device to the information provider.

The information provider loads the graphical interactive information system application from the developer into a graphical interactive information system application server 270. The graphical interactive information system application server 270 sends the graphical interactive information system application to the compact protocol inserter 272, which is similar to compact protocol inserter 212, and controls the operation of the compact protocol inserter 212 to allow, for example, the information provider to control the transport, such as VBI line used to broadcast the graphical interactive information system application. In another embodiment, graphical interactive information system application server 270 also controls the frequency of the application broadcast. Transmitter 274 is similar to transmitter 214.

This arrangement allows for multiple parties to contribute to the graphical interactive information system. Referring now to Figure 2A, 2B, and 2D, one embodiment of the providers of graphical interactive information is shown. Graphical interactive information system application developers 281, 282, 283, 284, 285 develop applications using compact protocol generators and formatters 276 for one or more broadcasters 286, 288, 290 who broadcast programs, graphical interactive information system applications using provider components 266, or both, to users and cable operators 292, 294, who rebroadcast signals to users from broadcasters 286, 288, 290 and may provide additional applications or broadcaster information using provider components 206 or 266.

#### B. Reception Component - Graphical Information System Application Display and Control.

In one embodiment, the reception component 234 is contained in the user reception equipment similar to conventional user reception equipment. Referring now to Figure 3, one embodiment of the user reception equipment 308 is shown. Conventional television receiver 310 such as a Sony KV32V55 is coupled to a set-top decoder 312 which is coupled via cable 322 to antenna 316. In one embodiment, antenna 316 is replaced by a cable 324 containing a CATV

transmission signal. The set-top decoder **312** is similar, but not identical, to a conventional set-top decoder, such as the Jerrold DPV7217/V5B available commercially from General Instrument Corporation of Hatboro, PA. The internal components of set-top decoder **312** according to the present invention are described below.

5 Referring again to Figure **2B** the reception component includes a tuner **216** to receive from input **219** and decode a broadcast signal containing the compact protocol. In one embodiment, tuner **216** is a conventional television broadcast tuner. In another embodiment, tuner **216** is a conventional CATV tuner. In another embodiment, tuner **216** is a conventional FM tuner. In another embodiment, tuner **216** is a conventional cellular telephone tuner. In  
10 another embodiment, tuner **216** is a conventional pager tuner.

The reception component also includes a data extractor **218** coupled to the tuner **216** to extract the compact protocol from the decoded broadcast signal. In one embodiment, the data extractor **218** is a conventional VBI inband data extraction circuit, such as part number  
15 SAA5296 available from Philips Semiconductors of San Jose, CA. In another embodiment, the data extractor **218** is a conventional modem. Other conventional data extraction equipment and techniques may also be used. In one embodiment, data extractor **218** provides a serial bitstream containing the extracted compact protocol onto bus **232**. Bus **232** is coupled to microprocessor **222** which stores via bus **232** the extracted compact protocol information into storage device **226** as instructed by a program stored in storage device **224**, and described below. In one  
20 embodiment, microprocessor **222** is a conventional 68040 microprocessor available commercially from Motorola, Inc., of Schaumburg, Ill., although any suitable microprocessor may be used. In one embodiment storage device **226** is a conventional addressable RAM memory array.

In one embodiment, the microprocessor **222** uses the error code information from the  
25 extracted data to check or correct errors, terminating the application if errors are detected. The microprocessor **222** may decode the data from the error coded data by removing the error code prior to storage in storage device **226**.

In one embodiment, storage device **224** is a conventional addressable ROM. In another  
30 embodiment, storage device **224** is a conventional flash memory which is readable and writable, yet retains its contents when power is no longer available. Such an embodiment allows any software or data which is resident in the reception component to be modified or changed by broadcasting it using the capabilities of the present invention. For example, a new feature of the reception component could be implemented via broadcast, eliminating the need for the user to replace a part of or all of the reception component to implement the new feature.

35 As described below, the microprocessor **222** uses the program stored in storage device **224** and the compact protocol information stored in storage device **226** to generate the graphical user interface display information, which is sent from the microprocessor **222** via bus **232** to a graphics display generator **228**. In one embodiment, the graphics display generator **228** is a conventional VGA graphics adapter, such as model number ET4000 available from Tseng Labs

of Newtown, PA, coupled to a conventional video genlock processor, such as model GSP500 available from Integrated Circuit Systems of Valley Forge, PA. The graphics display generator 228 is coupled to bus 232 to receive the graphical user interface generated by the graphical interactive information system.

5 In one embodiment, graphics display generator 228 also receives the broadcast signal corresponding to a broadcast program via line 227 from tuner 216 to allow simultaneous display of the broadcast program and the graphical interactive information system application. In another embodiment, graphics display generator 228 receives a broadcast program signal via line 229 from optional additional tuner 252, and line 227 is not used. This two-tuner 216, 252  
10 approach allows a graphical interactive information application to be displayed simultaneously with a broadcast program without requiring the application to be broadcast on the same frequency as the program.

The display generator 228 is coupled to a display 230. In one embodiment, the display 230 is an LCD display. In another embodiment, the display 230 is a conventional television  
15 receiver and the remaining elements 235 of the reception component as later described herein are contained in a set-top decoder.

In one embodiment, the microprocessor 222 is also coupled to a user input decoder 244 coupled to a user input receiver 250 to allow the user to communicate with the microprocessor 222 in order to operate the graphical interactive information system. In one embodiment, the  
20 user input decoder 244 is a conventional infrared remote control decoder. The user input receiver is a conventional infrared receiver 250 through which the user may use a conventional handheld remote control device, such as remote control 330 of Figure 3. Remote control keys pressed by the user translate to coded infrared signals that are received by infrared receiver 250, and are decoded by the user input decoder 244 and sent to the microprocessor 222 to allow the  
25 user to communicate with the interactive television system. In one embodiment, the microprocessor 222 responds to certain remote control keys decoded when they relate to choices displayed by the user component 234, but not to other remote control keys, to allow the operation of functions unrelated to the graphical interactive information system application simultaneously with the operation of the graphical interactive information system application using the same  
30 user input device.

In another embodiment, the user input receiver 250 is a conventional personal digital assistant keypad device and the user input decoder 244 is a conventional keypad decoder. In another embodiment, the user input receiver 250 is a conventional cellular telephone keypad device and the user input decoder 244 is the keypad decoder. In another embodiment, the user  
35 input receiver 250 is a conventional pager switching device and the user input decoder 244 is a conventional switching device decoder.

#### C. Reception Component - External Device Control.

In one embodiment, microprocessor 222 is coupled to a conventional infrared command encoder 256 which accepts an infrared command input and encodes a signal for a conventional

infrared emitter **258** to allow the interactive information system to control external devices, such as a VCR.

D. Reception Component - Return Channel.

In one embodiment, certain user responses are sent to a response collector for processing. Referring momentarily to Figure 1, button **118** allows a user to make a selection which will send a \$25 campaign contribution to the candidate **114**. Referring again to Figure 2B data line driver **246** accepts data from microprocessor **222** and sends it to communications port **248** to allow the microprocessor to send user responses and other information described below to a response collector who may process the responses. In one embodiment, the data line driver **246** is a conventional modem and communications port **248** is a conventional telephone jack, which allows the reception component **234** to send user responses to a response collector having a receiving modem connected to a conventional telephone line. In another embodiment, the data line driver **246** is a conventional DTMF tone dialer. In another embodiment, the data line driver **246** is a conventional controller for a system of addressable CATV set-top converters such as the ACC-4000 addressable controller available from General Instrument Corporation of Hatboro, PA, used to provide conventional pay-per-view services. In this embodiment, communications port **248** is coupled to receive the cable TV coax line **219** which is coupled to the tuner **216**.

E. Reception Component Tuner Control.

In one embodiment, microprocessor **222** is coupled to tuner **216** and optional tuner **252** to allow the microprocessor **222** to communicate with and control the tuned frequency of the tuners **216, 252**. This capability can provide such services as channel selection via the interactive information system. One such use of the service would be to allow a user to change channels from a program guide. The user's selection would automatically change the tuned frequency of the tuners **216, 252** to the desired channel.

In one embodiment, tuners **216, 252** contain a broadcaster information table, described below, in a storage device **217, 253** of the tuner **216, 252** identifying the broadcaster corresponding to each tunable channel. This allows the reception component to determine, for example, which channel number corresponds to the Cable News Network, which may be necessary because different cable systems carry Cable News Network on different channels. Storage devices **217, 253** are coupled to the microprocessor **222** to allow the microprocessor **222** to determine which tuner channel number corresponds to a particular station.

In one embodiment, the storage devices **217, 253** are ROMs, installed at the time of manufacture with the channel guide burned in. In another embodiment, storage devices **217, 253** are flash memory to allow the channel guide to be received and extracted from a broadcast signal like the compact protocol as described above, to allow microprocessor **222** to store the broadcaster information table in storage devices **217, 253**. In another embodiment, the broadcaster information table is broadcast as a part of the compact protocol described below, the broadcaster information table is stored in storage device **226**, and storage devices **217, 253** are not used.

### III. Compact Protocol.

The compact protocol is used to broadcast a compact set of information and commands from the information provider to the user in an efficient manner, allowing the use of low bandwidth transports such as the VBI.

5 Referring now to Figure 4, one embodiment of a method of sending and operating a graphical interactive information system using the compact protocol is shown. In one embodiment, an application header record is encoded and broadcast to initiate the process and describe the information which follows **410 412**. The application header record and the information will define a graphical interactive information system application. One or more  
10 desired graphical descriptions such as object or resource definition records and optional scripts or commands, each described below, are encoded and broadcast in any order **416, 418**. In one embodiment, the application header record is received and decoded **414** prior to the encoding of definitions, scripts and commands **416**, although other embodiments encode, broadcast, receive store and decode the application header record, definitions, scripts and commands in one unit. In  
15 one embodiment, no particular order of the steps described above is required as long as the application header definition is broadcast before the broadcast of any definition, script or command in the application. The information broadcast is received and decoded and used by the reception component to display the graphical information and to allow the user to interact with the information broadcast and perform the functions described herein **420, 422**. Some or all of  
20 the information broadcast may be stored at any time **420**.

In one embodiment, a graphical interactive information system application is broadcast again and again, allowing a user to tune to a program at any time yet receive the entire graphical interactive information system application.

Any desired updates as described below may be encoded and sent **424** and received and  
25 decoded **426**. If there are additional definitions or updates of resources or objects, they may be sent until the application is complete **428, 430**. In one embodiment, a termination command described below is broadcast to stop the operation of the application **430**.

As described below, a new application may be sent while an original application is in operation or transmission, for example, to allow a new advertisement application to interrupt an  
30 original program application, which resumes operation upon termination of the advertisement application. In one embodiment, the new application is also broadcast and operated using the method described above and shown in Figure 4. A suspend application command is sent by the new or original application in order to suspend the operation of the existing application, and a resume application command may be sent by either application to terminate the new application  
35 and resume the operation of the original application. In another embodiment, the new application must send a termination command in order to terminate itself, as a resume application command would only suspend the new application and resume the original application.

Because descriptions of standard graphical objects are transmitted in place of many of the bitmaps or other high-bandwidth display components which would otherwise be required, several advantages are realized. First, a low-bandwidth transport such as the VBI is adequate to allow the display of complex graphics. Second, the system is device-independent. The information provider simply describes the effect desired and each reception component reproduces it as best it can. An effect or image for which display is not allowed or not possible on the reception component can be ignored by that reception component, but displayed on other reception components.

A. Application Header Record.

In one embodiment, an application begins with an application header record to identify the information as the start of an interactive application. In one embodiment, if application information is received without an application header, the application may be stored, but may not run.

Referring now to Figure 5, one embodiment of an application header record 508 is shown. Byte 510 identifies the data as an application header record 508, by having a value equal to 1. Byte 512 describes the application type. Byte 512 having a value equal to 0 signifies a program application such as that described above for use with the politician's speech. Byte 512 equal to 1 signifies an advertisement application.

Byte 512 may have a value equal to 2, signifying a virtual interactive channel. Byte 512 may have other values, indicating other forms of applications.

Referring now to Figures 2A, 2B and 5, bytes 514, 515 contain the version and revision number, respectively, of the protocol used to communicate between the provider component 206 and the reception component 234 as described below. The receipt of version and revision numbers by a reception component 234 allows the reception component 234 to respond to protocols which are generated by different versions or revisions of the protocol generator 210. In one embodiment, the reception component 234 disregards a protocol which specifies a version number of which the reception component 234 is unaware or incompatible.

Referring again to Figure 5, long word 516 is an application identifier, a unique identifier which identifies the application. This information may be sent to a response collector to identify the information provider and application which generated the response. In one embodiment, a long word is four bytes in length, although other lengths may also be used.

Bytes 518, 522, and word 520 assist the microprocessor in its memory management function described below by identifying many of the memory requirements in advance. In one embodiment, a word is two bytes in length, although other lengths may also be used. Byte 518 contains the number of forms in the application, byte 522 identifies the total number of script resources, and word 520 identifies the total number of text, bitmap and picture resources defined by the application. These terms and their operation are described below.

In one embodiment, bytes of all records are broadcast in the order shown in the Figures 5, 6, 7B, 8, 9, 10, 11, 12, 13, 14A, 14B, 14C, 14D, 14E, 15, 16, 17A, 17B and 22.

## B. Graphical Object Definitions.

The compact protocol allows the broadcast of graphical interactive information by the use of a set of graphical object definitions. Graphical object definitions describe characteristics of graphical objects, such as size of the object, color of the object, location on the display, and other characteristics of the graphical object. Graphical objects include the form object, buttons on the form, bitmaps, pictures, lists, as well as non-graphical objects such as timers. In one embodiment, a text object contains descriptive information such as font and color about a text string, as well as the location of the text string, but does not contain the text string itself. Text strings are resources, and are separate from a text object which describes them.

### 1. Form Definition Record.

Each application may contain one or more forms. A form is a collection of objects which are defined as a single unit by the information provider using a form definition record. Objects in a form which are capable of being displayed are displayed together.

Referring now to Figure 6, one embodiment of a form definition record 608 is shown. Byte 610 has a value of 2 to identify the record as the start of a form definition. Word 611 is the size, in bytes, of the form definition record. Byte 612 is an identifier assigned by the information provider to identify the form defined by the form definition record 608. In one embodiment, a second form having the same form number as one already defined in an application is ignored. Block 614 contains one or more object definitions for the form as described below.

Referring now to Figures 2B and 6, in one embodiment, after microprocessor 222 receives a form definition record 608, the microprocessor 222 under control of a program stored in storage device 224 allocates an area of the storage device 226 for the form, the objects on the form, resources required by the form and application control information to allow the user to interact with the form. Microprocessor 222 generates and stores several tables in storage device 226 as described below.

### 3. Object Definitions.

Several standard objects may be defined using compact object definitions, which allow the user to specify the look of graphical objects by transmitting an object identifier as the first byte of the object, and only a few parameters.

#### a. Form Objects.

One type of object is a form object. A form object defines a rectangular region of the screen and the appearance of the region. The information provider defines form objects using a form object definition record.

Referring now to Figure 7A, one embodiment of a form object 700 having a border 706 and an interior 702 is shown displayed on a screen 703 of a conventional television set 704.

The form object may be transparent, in which case the other objects in the form appear to float over the display. If the display is a television screen, and the application is not a graphical interactive virtual channel, a transparent form object can cause the other objects in the form to

appear to float over the broadcast picture. Otherwise, the form object covers all or a part of the broadcast picture and the objects may cover all, a part, or none of the form.

Referring now to Figures 7A and 7B, one embodiment of a form object definition record 708 is shown. Byte 710 identifies the object as a form by having a value of 000001 in the least significant six bits. Bytes 712, 714, 716, 718 contain the position of the left side, top, right side and bottom of the form 700, respectively, relative to the center 701 of the screen 703 using a coarse coordinate system. A coarse coordinate system is a representation of a unit of width and height. In one embodiment, the unit of width and height is selected to allow representation of the entire width or height of the display in a single byte of 256 unique numbers. In one embodiment, the display is a North American television signal television screen according to NTSC standards having a width of 160 color clock widths, each color clock width being the width covered by the electron beam in 280 nanoseconds, and a height of 400 interlaced scan lines. In one embodiment, coarse coordinate units equal one color clock in width and two scan lines in height. In one embodiment, the center 701 of the screen 703 is represented as coarse coordinates 128, 128.

Byte 719 contains a description code for the style of the border 706 of form 700. In one embodiment, valid description codes are 0 for no border, 1 for a thin line border, 2 for a thick line border, 3 for a gothic style border, and 4 for a border having a "wavy" appearance, though other embodiments could use other codes or styles. Byte 720 contains a color code for the color of the border 706. Byte 721 contains a color code for the color of the interior 702 of the form 700.

Byte 722 and word 724 are used to locate the script, described below, for the form. Byte 722 is an index into a script handle table for the location of the first byte of a script resource containing the script to execute. A script handle table is a table of pointers to the script resources for the application. A script resource is a block of memory which may contain numerous scripts. In one embodiment, a script resource may not exceed 64K bytes in size. Word 724 contains the offset from the first memory location of the script resource to the initialization script.

If the most significant bit of byte 710 is set, block 730 contains optional hint information regarding the appearance of the form, such as textured appearance or transition effects such as fade in and fade out. Hints for one embodiment are listed in Appendix A. If the capabilities of the user's interactive system cannot accommodate the appearance or effects indicated by the hints, the interactive system may ignore the information or display it as closely as possible. If the most significant bit of byte 710 is cleared, block 730 contains no bytes and is not used.

#### b. Button Objects.

Another object is the button object. Referring now to Figure 1, buttons 118, 124 are selected by the user in order to interact with the graphical interactive information system. A button is defined by the information provider using a button object definition record.

Referring now to Figure 8, one embodiment of a button object definition record 808 is shown. Byte 810 has a value of 2 to identify the definition as a button object. Bytes 811, 812, 813, 814 identify the positions of the left edge, top edge, right edge, and bottom edge of the button as a distance from the upper left hand corner of the form in coarse coordinate units.

5 Word 816 contains a resource number corresponding to a text, bitmap or picture resource to use for the button. Numbers on the button are inserted automatically on this image based upon the location of the button on the form. Optional byte 817 contains text color information, and optional word 818 contains bits corresponding to the font, size and style of the text if the resource is a text resource, indicated by setting the second most significant bit in Byte 817.

10 Resources are described below. In one embodiment, the text size measurement is in 1/500th of a display screen height.

Byte 820 contains an index into the script handle table to the pointer for the script resource containing the script to execute when the user selects the button. Word 822 contains an offset from the start of the script resource to the script to be executed when the user selects the

15 button.

The most significant bit of byte 810 is set if hint information exists in block 828. A hint is a description of how an object can appear on certain systems capable of displaying such an appearance. Where the reception component is not capable of such a display, the hint may be ignored, or the reception component may provide an appearance matching the desired

20 appearance as closely as possible. Numbers are assigned to buttons and displayed by the reception component, but these assignments may be overridden using hints. Other hints for one embodiment are listed in Appendix A. Optional block 828 contains one or more bytes of the hint data if the most significant bit of byte 810 is set, and block 828 contains no bytes otherwise.

### c. Text Objects.

25 Text object descriptions are provided by the information provider to describe the location and appearance of text, but do not contain any of the actual text itself. The text itself is a resource, described below.

Referring now to Figure 9, one embodiment of a text object definition record 908 is shown. Byte 910 contains an object type identifier having a value of 3 to indicate the object is a

30 text object. Bytes 912, 914, 916, 918 describe the left edge, top edge, right edge and bottom edge, respectively, in coarse coordinate units from the upper left corner of the form object, of a box into which the text resource may be placed by the reception component. Byte 920 contains a code for the color of the text. Byte 922 contains text alignment information. Word 924 contains the resource handle of the text string which the reception component is to display in the box.

35 Word 926 defines the font, size and style to use to display the resource. The font makes up the first four bits, the size makes up the next six bits and the style makes up the remaining six bits of word 926.

Block 932 contains optional hint flags, size and data similar to the hints described above and shown in Figure 8.

d. Bitmap Objects.

A bitmap object is used to display a bitmap resource, described below, on the form. An information provider defines a bitmap object using a bitmap object definition record.

Referring now to Figure 10, one embodiment of a bitmap object definition record 1008 is shown. The least significant six bits of byte 1010 contain an object type identifier having a value of 4 to indicate the object is a bitmap object. Bytes 1012, 1014, 1016, 1018 define the left edge, top edge, right edge and bottom edge, respectively, in coarse coordinate units from the upper left corner of the form object, of a box into which the bitmap may be placed.

Word 1022 contains a handle to the resource containing the bitmap. Block 1032 provides hints as described above and shown in Figure 8.

e. List Objects.

A list object provides the user with a list of options and allows for a selection of one or more options. An information provider defines a list object using a list object definition record.

Referring now to Figure 11, one embodiment of a list object definition record 1108 is shown. The least significant six bits of byte 1110 contain an object type identifier having a value of 5 to indicate the object is a list object. Bytes 1111, 1112, 1113, 1114 define the left edge, top edge, right edge and bottom edge, respectively, in coarse coordinate units from the upper left corner of the form object, of a box into which the list may be displayed.

If the second most significant bit of byte 1110 is set, then word 1116 holds font, size and style information similar to word 926 of Figure 9 and Byte 1117 holds the color code of the list, otherwise word 1116 and byte 1117 are unused. Byte 1118 holds the number of entries in the list, and byte 1120 allows a default selection to be specified using the order of the entries in block 1122 beginning with entry 0. In one embodiment, the default selection is initially highlighted to indicate which entry will be selected by the user if the user selects a button marked "yes" as instructed by the scripting commands described below. Block 1122 contains one or more words containing the resource handle, described below, of the each entry in the list.

Optional block 1128 provide optional hint data as described above and shown in Figure 8. In one embodiment, the reception component displays the resources along with a number it assigns to each resource to accommodate selection by the user, unless overridden by hints. In another embodiment, user responses, such as specific remote control keys, are assigned to move a cursor up or down the items in the list.

f. Timer Objects.

Timer objects allow the graphical interactive information system application to use timed events, such as a timed response to a question in a game. An information provider defines the timer object using a timer object definition record.

Referring now to Figure 12, one embodiment of a timer object definition record 1208 is shown. The least significant six bits of byte 1210 contain an object type identifier having a value of 6 to indicate the object is a timer object. The second most significant bit of byte 1210 is a flag indicating if the timer operates one time, or restarts again after each period has elapsed. Word

1212 contains a value equal to the period of the timer in 1/60ths of a second. Byte 1214 contains the script handle of the script resource containing the script to execute at the end of the period indicated as described above. Word 1216 contains an offset from the start of the script resource specified as described above to the script to execute when the period has elapsed from the time the object is received or the last period ended.

g. Picture Objects.

A picture object allows an information provider to define a picture using a picture resource, which is a list of several bitmaps, text resources and drawing primitive functions, which can allow the picture resource definition to be more compact than an equivalent single bitmap resource. An information provider defines a picture object using a picture object definition record.

Referring now to Figure 13, one embodiment of a picture object definition record 1308 is shown. Byte 1310 contains an object type identifier having a value of 7 to indicate the object is a picture object. Bytes 1312, 1314, 1316, 1318 define the left edge, top edge, right edge and bottom edge, respectively, in coarse coordinate units from the upper left corner of the form object, of a box into which the picture resource may be placed.

Word 1322 contains the handle of a picture resource, described below, to display in the box. Block 1328 provide hints as described above and shown in Figure 8.

C. Resource Definitions.

Unlike object definitions which define the appearance of an object, resources represent data which can be displayed. The compact protocol also allows the information provider to define certain resources, such a bitmaps, to provide the pictures or icons 120, 122 shown in Figure 1. Text is also provided through the use of resources. Some resources are predefined, and others may be defined by the information provider. An information provider defines resources using resources definition records.

Referring now to Figure 14A, one embodiment of a resource definition record 1408 is shown. Byte 1410 identifies the record as a resource definition record by having a value equal to 2. Word 1411 contains a value equal to the number of bytes in the resource definition record. Word 1412 is the resource handle of the resource.

In one embodiment, four types of resources may be defined in block 1414, a text resource, a bitmap resource, a picture resource and a bitmap resource list. The stored program in the storage device of the reception component will interpret the resource and format it according to the capabilities of the reception component so that it may be rendered as closely as possible to the definition. If necessary, the stored program may discard a resource definition data that it cannot use, for example, because the resource has a higher resolution than the reception component is capable of rendering as described below.

1. Text Resources.

A text resource contains text data. Referring now to Figure 14B, one embodiment of a text resource 1428 is shown. Byte 1430 having a value equal to 1 identifies the resource as type text, and block 1432 contains a null terminated text string, such as ASCIIZ.

5 2. Bitmap Resources.

A bitmap resource is used to hold bitmaps. Bitmaps are described in Kliewer, *EGA/VGA Programmer's Reference Guide* (2nd. ed., McGraw Hill 1990). Referring now to Figure 14C, one embodiment of a bitmap resource 1438 is shown. Byte 1440 having a value equal to 2 identifies the resource as type bitmap. In one embodiment, the resolution of the bitmap is higher  
10 than the coarse coordinate system, allowing the utilization of the full display resolution of the reception component. Bytes 1441, 1442, 1443, 1444 define four colors for use as described below. Word 1446 defines the width in pixels of the bitmap and word 1448 defines the height of the bitmap in pixels. Block 1450 contains one or more bytes of the bitmap data, each byte in  
15 block 1450 containing four pairs of bits, each pair representing one of the four colors defined above, of a pixel. Each pixel is drawn to the right of the pixel before until the pixel width 1446 is reached, at which point the next pixel is drawn at the left boundary of the next row and the process repeats until all the pixels are drawn.

Any form of bitmap or similar format may be used. For example, bitmaps using a byte per pixel, where each byte represents the color of a pixel, may be used.

20 In one embodiment, the bitmap data is compressed using such compression techniques as conventional run-length encoding.

3. Picture Resources.

Picture resources are used to hold zero or more graphical elements such as text strings, bitmaps, and primitive drawing functions, as well as relative position information. Referring  
25 now to Figure 14D, one embodiment of a picture resource 1458 is shown. Byte 1460 having a value equal to 32 identifies the resource as type picture. Word 1462 contains the number of bytes in the picture resource definition record. Block 1464 contains zero or more picture resource elements described below.

Referring now to Figure 14E, one embodiment of a picture resource element is shown.  
30 The least significant six bits in byte 1470 indicate the type of the element. Element types include text or bitmap resources, as well as drawing functions such as ellipse, circle, horizontal line or vertical line. The type codes are listed for one embodiment are: text = 24, bitmap = 32, point drawing function = 1, horizontal line drawing function = 2, vertical line drawing function = 3, rectangle drawing function = 4, filled rectangle drawing function = 5, diagonal line drawing  
35 function = 6, ellipse drawing function = 7, circle drawing function = 8, and spline drawing function = 9. The most significant bit of byte 1470 indicates the last element in the picture resource, allowing multiple elements to be a part of a picture resource. Bytes 1472, 1474 contain the x and y coarse coordinate relative to the center of the screen of the upper left corner of the element, and bytes 1476, 1478 contain the x and y coarse coordinates relative to the center of the

screen of the lower right corner of the element, except for the horizontal line drawing function, which does not contain byte 1478, the vertical line drawing function, which does not contain byte 1476, and the point drawing function and bitmaps which do not contain bytes 1476 or 1478 because in each case, the omitted byte or bytes are unnecessary. Byte 1480 contains the color code for the element, unless the element type is bitmap. Word 1482 contains a resource handle if the type is text or bitmap, otherwise, word 1482 is unused. Block 1484 contains additional information if the type is text, similar to word 926 of Figure 9.

#### 4. Resource Lists

Resource lists contain one or more bitmap resources. Referring now to Figure 14F, one embodiment of a resource list 1488 is shown. Byte 1490 contains a unique value to identify the resource as type resource list. Block 1492 contains one or more resource list elements.

Referring now to Figure 14G, one embodiment of a resource list element 1498 is shown. Word 1497 contains an offset to the byte following the resource list element, or zero if resource list element 1498 is the last element in the list. Block 1499 contains a bitmap resource described above and shown in Figure 14C.

#### D. Indexing Definitions.

Referring now to Figure 2B, in one embodiment, microprocessor 222 performs several memory management functions. Microprocessor 222 maintains in storage device 226 a pointer to each form in an application using a form handle table. The form handle table contains a pointer to the first byte of each form object in the application. The objects in each form are stored as a linked list, with the form object pointing to the first object in the linked list. An object is located by using the form handle table to locate the form, and then traversing the linked list until the desired object is located. In one embodiment, objects may be referenced by type and position in the list. For example, button 3 is the third button found while traversing the list. In another embodiment, all objects are sequentially numbered in the list, and objects are referred to by this object number.

The location of each resource is stored using a resource handle table in which each entry in the table contains a pointer to the resource. The resource is located by using a resource handle index to locate the pointer in the resource handle table, and using the pointer to locate the resource.

Because several applications may be resident in the storage device 226 at one time, more than one set of the tables and lists described above may be maintained by microprocessor 222, allowing a program application to stay resident while an advertisement application is operating, so that the program application need not be reloaded after the end of the advertisement when the program resumes. The program application or advertisement application may be suspended or terminated by an advertisement application. In one embodiment, more than one advertisement application may be resident in storage device 226 to allow a user to send a response to one advertisement application after the advertisement terminates, yet still receive the application for the following advertisement. In one embodiment, only the form or forms of the application

related to the response will remain in storage device **226** after microprocessor **222** receives a second advertisement application.

In one embodiment, a program application is allocated a larger percentage of memory than an advertisement application due to the longer running time of the program application. In one embodiment, a program application may occupy 75% of the available memory as described below, leaving 25% for one or more advertisement applications. A virtual interactive channel application may occupy 100% of the available application memory.

In one embodiment, memory is allocated by limiting the number of available handles in the application's handle table based upon the type of application as described above. Although this embodiment does not strictly enforce the actual memory usage of the application, it provides a reasonable level of protection without a significant increase in complexity of memory management. In this embodiment, the number of handles to be allocated may be based upon experience of the average size of the memory required as a result of each entry in the handle table. In one embodiment, the average size per entry is 50 bytes.

In another embodiment, memory itself is allocated by tracking the amount of memory a graphical interactive information system application uses as the memory is reserved, and terminating the application if the application's memory allocation is exceeded.

#### E. Updates.

The compact protocol also allows the information provider to update information used by previous definitions so that the appearance of a form can be modified quickly without resending a large amount of data required to resend the entire application or form. An information provider sends an update record to replace a form, one or more objects on a form, or one or more resource definitions in an application.

Referring now to Figure **15**, one embodiment of an update record **1508** is shown. Byte **1510** having unique values to identify the record as an update record to update a form, one or more objects on a form, or one or more resources, respectively. Word **1512** identifies the size in bytes of the record. Block **1514** is the handle of a form to replace, the form containing the objects to replace or the resource to replace. Block **1516** contains a form object definition record, one or more button, text, bitmap, picture, timer or list object definition records, or text or bitmap resource definition records described above to replace the object or resource indicated in byte **1514**.

In one embodiment, entire forms are updated by storing the objects of the form and adjusting the handle to the old form to point to the new form. One or more objects in a form may be updated by storing the new object and then inserting the new object in the linked list making up the form in place of the old object. A resource is updated by storing the new resource and adjusting the resource handle table to point to the new resource.

#### F. Instructions.

The compact protocol also allows the information provider to send instructions to the reception component to control the operation of the interactive information system.

A form may be displayed using a two byte command. The first byte has a value equal to 5 to indicate the command is a form display command, and the second byte contains the form number. The form display command allows the information provider to display a form without any input from the user.

5 A program application may be suspended or resumed by an advertisement application or virtual channel using the single byte commands suspend and resume, having a value of 6 and 7, respectively. An application may be permanently terminated by sending a single byte command having a value equal to 8.

#### G. Interactive Icon Definition.

10 In one embodiment, an interactive icon is shown on the display to indicate an interactive application has been received by the reception component. The user can then press one or more keys on the remote control to display the first form of the application. The information provider may control the icon displayed by sending an interactive icon definition record.

Referring now to Figure 16, one embodiment of an interactive icon definition record  
15 **1608** is shown. Byte **1610** contains a value of 9 to identify the record is an interactive icon definition record. Bytes **1612, 1614, 1616, 1618** define the distance in coarse coordinate units from the center of the screen of the left edge, top edge, right edge and bottom edge, respectively, of a box in which the interactive icon will be displayed. The upper left edge of the icon is placed at the upper left edge of the box defined. Word **1620** is the resource handle of the resource to be  
20 displayed as the icon.

#### H. Scripts.

Scripts are a sequence of one or more scripting commands provided by an information provider. A script may be executed when received, or may be executed in response to an action.

In one embodiment, the compact protocol allows an information provider to send a script  
25 which is executed upon receipt and then discarded. An information provider defines the script to execute using a script execute record. Referring now to Figure 17A, one embodiment of a script execute record **1708** is shown. Byte **1710** having a unique value to identify the record as a script execute record. Word **1712** contains the number of bytes in the script execute record. Block **1714** contains the script resource, containing one or more codes as described in Appendix B.

30 The compact protocol also allows the information provider to provide scripts defining the operation of the system in response to user selections or other events. Four objects may have scripts associated with them: forms, lists, buttons, and timers. The form object script is executed when the form is displayed. A list object script is executed when the user indicates a selection. A button object script is executed when the user selects the button. A timer object script is  
35 executed at the end of the timer period.

A script can display or hide a form or an object on the form, modify an object's characteristics, such as color or size, or modify which resource an object will use. A script can also declare variables unique to the script and change the values of those variables. A script can

use standard logic functions, such as "or", "and", "if..then", etc. In one embodiment, the script can perform all the math and logic functions of a conventional basic interpreter.

Referring now to Figure 17B, one embodiment of a script resource 1718 is shown. Byte 1720 having a unique value to identify the resource as a script resource. Word 1722 contains the number of bytes in the script resource. Byte 1723 contains the handle used as an identifier of the script resource. Block 1724 contains the script resource, containing one or more codes as described in Appendix B.

Responses are scripted as well, including the formatting of a response byte or byte containing product information, quantity, or the like. In one embodiment, a script may contain one or more of four unique scripting commands which generate responses.

An "order" scripting command allows a user to use the interactive information system to order a product or service from a vendor. An order scripting command contains a one-byte code representing the command, one word of cost information and a one byte variable indicator to allow the information provider to indicate a variable to return as described below. The cost information may be used by the reception component 234 of Figure 2B to check the price of the order to verify that it does not exceed a user's predefined limit to assist the user for budgeting purposes. The variable indicator is a code to indicate a variable to return as described below. The variable may be built by the information provider using the scripting language, and in one embodiment, the variable is four bytes in length.

A "request" scripting command allows a user to request information for no charge. A request scripting command is similar to the order scripting command, but, no cost information byte is passed to the reception component for verification.

Two scripting commands are used which generate anonymous responses described below. A "respond" command has a format similar to the request scripting command, to allow the generation of a four byte response to be defined by the information provider using the scripting language. A "vote" scripting command is a single byte command which generates a response having only one byte which contain predefined codes for "yes", "no", "abstain" and "don't know," to allow for simple, compact response generation.

Referring now to Figure 2A, scripts are defined by the information provider using the compact protocol generator 210. In one embodiment, the compact protocol generator 210 has a user interface allowing characteristics of objects to be defined or modified or other actions to be taken using an object oriented format, such as "form1.show" to display the first form. Other commands such as assignment of variables and logic functions are defined using a set of commands similar to the BASIC programming language.

The protocol generator converts the BASIC-like commands to one or more numeric codes, and includes the codes in the application broadcast. One embodiment uses the codes described in Appendix B.

In one embodiment, scripts are stored in a script resource, which is an area of memory up to 64K bytes long which stores one or more scripts. A script handle table keeps track of all script

resources by storing the memory location of the first byte of each script resource. The precise location of the start of each script is provided to the system as an index into the script handle table, and an offset from the location pointed to by the script handle table entry corresponding to the index.

5 Scripts are executed using a command interpreter which performs the functions indicated until it reaches an end of script identifier. In one embodiment, the script instructions are interpreted directly from the codes which make up the script resource, and in another embodiment, script instructions are first converted into C++ code prior to interpreting them.

#### IV. Broadcaster Information.

10 Referring now to Figures 2A, 2B, 2C and 18C, in one embodiment, an information provider such as a cable television operator uses the provider component 266 to create, insert and broadcast broadcaster information as a graphical interactive information system application for reception and decoding by a reception component 234.

15 In one embodiment, the information provider provides broadcaster information to allow a reception component 234 to build a broadcaster information table. A broadcaster information table organizes some or all broadcaster information to allow the reception component 234 to locate the tuned frequency or other identifier of a broadcaster or an application.

20 Broadcaster information may reach the information provider in a variety of ways. Broadcasters or other information providers may send broadcaster information relating to their broadcasts to the information provider. For example, the transport a broadcaster uses to broadcast graphical interactive information system applications, such as VBI line 14, and the broadcaster's network identifier, such as CNN, may be provided by the broadcaster to the information provider who will provide broadcaster information. The broadcaster can also identify whether it provides programs, interactivity or both, and any interactive information system protocols it uses. Thus, a broadcaster may be an information provider for interactive information system applications it broadcasts, and provide content to another information provider, the cable operator, who broadcasts the broadcaster information via its own provider component 206.

30 The information provider who will broadcast the broadcaster information can assemble information received by others, provide its own broadcaster information or both. For example, the cable operator can provide the channel guide containing a frequency identifier such as the frequency or channel number and call letters for each of the broadcasters on the cable system in addition to information it receives from broadcasters or other parties.

35 In one embodiment, an information provider broadcasts a broadcaster information table by broadcasting broadcaster information such as broadcast channels available to the user, the broadcast frequency corresponding to the channel, call letters corresponding to a broadcaster on the channel, network identifiers for the broadcasters, or interactive information protocol or location information for a broadcast or an application 1810, whether a broadcaster broadcasts programs, graphical interactive information system applications or both 1811, a broadcast

program tuned frequency location identifier **1812**, and interactive information system application tuned frequency identifiers **1814** for the broadcaster or for particular applications broadcast by the broadcaster or others.

Referring now to Figures **2B** and **18B**, in one embodiment, the reception component  
5 receives the broadcaster identifiers **1820**, whether a broadcaster broadcasts programs, graphical interactive information system applications or both **1821**, broadcast program tuned frequency location identifiers **1822**, and interactive information system application tuned frequency identifiers **1824** and stores this information in storage device **226**.

Referring now to Figures **2B** and **18C**, a desired frequency is located given any of the  
10 entries in the broadcaster information table by locating a desired entry **1830**, identifying the tuned frequency of the desired broadcaster or interactive information system application **1832** and tuning the desired frequency **1834**. for example, if channel 4 contains KRON, the NBC affiliate, broadcasting graphical interactive information system applications on line 14 of the VBI on channel 9, this information is stored in the reception component **234** as described above. An  
15 interactive application corresponding to channel 7 may instruct the reception component **234** to switch the tuned frequency of the program channel to the NBC affiliate using a command which only identifies NBC as the target channel. The interactive information system reception component **234** may then identify the proper channel corresponding to the NBC affiliate as channel 4 by locating the desired broadcaster in the broadcaster information table, identifying the  
20 tuned frequency or channel of the desired broadcaster from the entry containing the broadcaster information **1832** and switch the tuned frequency of a tuner in reception component to the channel or frequency of the desired broadcaster or application **1834**. When tuner **216** is changed to channel 4, either by the user or an interactive information system application, reception component **234** under control of microprocessor **222** using the broadcaster information table can  
25 switch tuner **252** to channel 9 and decode the line 14 of the VBI to obtain interactive information system applications corresponding to the broadcast program on channel 4. In one embodiment, the previous channel or application information is stored in storage device **226** to allow the interactive information system to return the user to the original channel 7, for example if the user exits the new application or the interactive information system application on line 14 of the VBI  
30 of channel 9 is not received.

Referring now to Figure **2B**, as described above, in one embodiment, information related to interactive information system applications may also be broadcast, received and stored as a part of the broadcaster information table. If graphical interactive information system application number 5407138 will be broadcast by KRON, this information may also be a part of the  
35 broadcaster information table, allowing the interactive information system to locate this application upon command, for example, from another interactive information system application, without changing the program channel, for example by changing the tuned frequency of tuner **217** without changing the tuned frequency of tuner **252**.

In one embodiment, the developer uses the compact protocol generator and formatter 276 to create interactive information system applications which refer to other applications by using application identifiers, and the graphical interactive information system application server 270 allows the broadcaster to further modify the application by adding available broadcaster information regarding the other applications to allow the reception component to locate the other applications.

#### V. Image Generation.

An application may display the first form when the reception component receives the application header record, the first form definition, including objects for that form, and resources related to the objects on the form. Additional forms may be broadcast while the first form is being displayed. In one embodiment, if the user response causes the application to display a form for which the form definition or one of the required object or resource definitions has not been received by the reception component, the application will wait for 10 seconds for the receipt of the missing information, and if not received, abort the application and display an error message.

Referring now to Figure 2B, display generator 228 contains an addressable video RAM. When a VGA color code is written into the video RAM of the display generator 228, a pixel appears on the display 230 corresponding to the address of the code written. Thus by sending various bitmaps, the form is displayed. The use of bitmaps and video display adapters is described in Kliewer, *EGA/VGA Programmer's Reference Guide* (2nd. ed., McGraw Hill 1990).

In one embodiment, all color codes are broadcast as VGA color codes. VGA color codes are described in Kliewer, *EGA/VGA Programmer's Reference Guide* (2nd. ed., McGraw Hill 1990). In another embodiment, a different set of color codes are used. In one embodiment, the color code is converted at display time to a color suitable for the reception component by mapping it to another color. For example, some of the VGA color codes are too bright for use on certain displays, such as color televisions, and thus, a 256 entry lookup table is used to convert the VGA code into the acceptable code. In one embodiment, the result of the lookup reduces the saturation of the RGB values by 25%. In another embodiment, codes indicating saturation of the RGB values in the top 25% are held to 75% of the maximum. The 25% value was selected to accommodate the color restrictions imposed by the NTSC video signal standards, and conventional color television circuitry. The lookup table approach can map to any number of colors. In one embodiment, 100 colors are used, another embodiment uses sixteen colors, and another embodiment uses only two colors.

The reception component stores bitmap resources defined using bitmap resource definitions described above in storage device 226. In one embodiment, all text characters in various fonts, styles and type sizes are stored as predefined bitmaps in storage device 224 to allow for rapid display of these characters. In another embodiment, these text characters are stored as outline fonts, and bitmaps are generated from the outline fonts. Other predefined

resources are also stored to allow commonly-used objects such as bitmaps of credit cards. Predefined resources are listed in Appendix C.

Referring now to Figure 19, a method of generating the images from the form object and other object definitions is shown. When a display form command is received, either via the broadcast or via a script, the video RAM is erased 1910 and the objects and resources are drawn. In one embodiment, the form object is drawn first 1912, followed by the objects and resources appearing on the form 1914, 1916 until all objects and resources are drawn 1920. This allows the objects and resources to appear overlaid onto the form. Objects and resources are located using the handle tables described above.

Referring now to Figure 20, one embodiment of a method of drawing an object is shown. An object is drawn by reading the corresponding object definition 2010, generating a bitmap corresponding to the object definition read 2012 and sending it to the graphics display generator 2014. In one embodiment, the entire bitmap is generated 2012 prior to sending 2014. In another embodiment, portions of the bitmap are generated 2012 and sent 2014 until the entire bitmap is complete 2016, 2018. Generating the bitmap is accomplished by rendering the color of each pixel within the boundary of the object as specified by the object definition.

Referring now to Figure 21, one embodiment of a method of drawing a resource is shown. Each bit in the bitmap of a resource is read 2108 and translated 2110 into the format of the graphics display generator if required. For example, each bit in a four-color bitmap resource may be translated into a modified VGA color code as described above. The translated bit is sent 2112 to the graphics display generator using the position information in the resource definition for display by the display device. In one embodiment, all of the bits are assembled 2110 into a bitmap prior to sending 2112, and in another embodiment, each bit is sent after translation 2112. The method continues until the resource is drawn 2114, 2116.

## 25 VI. Response Generation

When an application allows a response and the user has a reception component capable of transmitting the response, the user may provide response information to a response collector. Referring now to Figure 2B, in one embodiment, each reception component 234 is assigned a unique code at the time of manufacture and this code is stored in the storage device 224. Individual users of the reception component 234 may also be assigned a unique code. When the user responds to an object which generates a response, the reception component generates a response record to allow the response collector to route the response as described below.

Referring now to Figure 22, one embodiment of a response record 2208 is shown. Long word 2210 contains the unique code of the reception component, and long word 2212 contains the unique application code sent in the application header. Byte 2214 contains a user identifier, to allow the user to distinguish himself from others who may use the reception component. In one embodiment, anonymous responses do not contain the reception component or user identifier 2210, 2214 to allow for the user to maintain anonymity. Block 2216 contains the defined response information byte or bytes described above to designate quantity or product information

according to the user's response. In one embodiment, a passcode is maintained in the reception component, and the user is required to enter it to generate the response to the response collector.

Referring now to Figure 23, a response network containing three reception components, one response collector, and two vendors is shown. User reception components 2310, 2312, 2314  
5 are coupled to response collector forwarding equipment 2316 via communication lines 2311. Communication lines 2311 may be permanently connected or temporarily arranged as needed. In one embodiment, communications lines 2311 are arranged through the public switched telephone network when a reception component 2310, 2312, 2314 dials a telephone number of the response collector. In another embodiment, communications lines 2311 are cable television cables. Any  
10 form of communication, even using an intermediary such as telephone equipment owned by the telephone company, will allow operation of the present invention. In one embodiment, response collector forwarding equipment 2316 is an industry standard UNIX-based computer system coupled to at least one modem to receive and/or transmit data.

The response collector forwarding equipment 2316 is coupled to vendor ordering  
15 equipment 2318, 2320 using communication lines 2319 similar to communication lines 2311 to allow the response collector equipment 2316 to react to the receipt of responses sent by a reception component 2310, 2312, 2314 by sending user information and other information to vendor ordering equipment 2318, 2320 as described below.

Referring now to Figure 24 a method of collecting and sending confidential user  
20 information such as credit card number to a vendor is shown. The response collector obtains user information such as reception component number, user number, name and address, and confidential information such as credit card number 2408, 2410. In one embodiment, this is accomplished by mail. In another embodiment, this step is accomplished by telephone. In one embodiment, the information is verified, for example by checking the credit card billing address  
25 with the address provided by the user 2411.

The response collector obtains routing information and an application identifier from the information provider 2412, and associates the routing information with the application identifier.

The application identifier broadcast to the user as described above and a user reception component and user identifiers are sent to the response collector 2414. Because no confidential  
30 information is sent, unsecure communication lines may be used to send the information. The response collector then forwards the user information including user confidential information and response information to the vendor associated with the application identifier received 2416. This step may be accomplished using a secure facility, such as mail or telephone line. The vendor may then provide a service or products to the users address with less likelihood of fraud.

Appendix A

## Hints

Null  
 Invisible  
 5 Disable  
 Foreground Color  
 Background Color  
 Border Color  
 Border Style  
 10 Border Width  
 Border Options  
 Form Transition Effect (Fade Out, etc.)  
 Form Background Gradient Fill  
 Clip  
 15 Scale to Fit  
 Scale  
 Text Private (Not seen - use for passwords, etc.)  
 Text Numeric  
 Text Editable  
 20 Appearance of Buttons  
 Key 0  
 Key 1  
 Key 2  
 25 Key 3  
 Key 4  
 Key 5  
 Key 6  
 Key 7  
 30 Key 8  
 Key 9  
 Key Select  
 Key Up  
 Key Down  
 35 Key Left  
 Key Right  
 Key Enter  
 Key Exit  
 Key Cancel  
 40 Key Buy  
 No Legend  
 Keycap Custom  
 Keycap Round  
 Keycap Square  
 45 Keycap Diamond  
 Keycap Over  
 Keycap Under  
 Keycap Left  
 Keycap Right  
 50 Cursor Related Hints for Systems with Cursors  
 Box (when cursor is inside box, user may press enter)  
 No Box (no box needed around object)

List Hints

- Highlight Color
- List Exclusive
- 5 List Exclusive None
- List Non Exclusive
- List Horizontal
- List Vertical
- List Sort Ascending
- 10 List Sort Descending
- List Control Up (Indicates button which makes list scroll)
- List Control Down
- List Control Left
- List Control Right

15

Timer Hints

- Timer Random During Period

Appendix B  
Script Codes

<u>Statements</u>		<u>Token Value</u>		
5	IF	0x10		
	WHILE	0x11		
	{function call statement}		0x12	
	RETURN	0x13		
	{integer assignment}	0x14		
10	{string assignment}	0x15		
	{boolean assignment}	0x16		
<u>Expressions</u>		<u>Token Value</u>	<u>Arguments</u>	<u>Return Value</u>
	{integer variable}	0x20	none	Integer
15	{string variable}	0x21	none	String
	{boolean variable}	0x22	none	Boolean
	{integer constant}	0x30	none	Integer
	{string constant}	0x31	none	String
	{boolean constant}	0x32	none	Boolean
20	<=	0x40	Integer, Integer	Boolean
	<	0x41	Integer, Integer	Boolean
	{integer equal}	0x42	Integer, Integer	Boolean
	{string equal}	0x43	String, String	Boolean
25	{boolean equal}	0x44	Boolean, Boolean	Boolean
	{string compare}	0x45	String, String	Boolean
	{is substring}	0x46	String, String	Boolean
	AND	0x47	Boolean, Boolean	Boolean
	OR	0x48	Boolean, Boolean	Boolean
30	NOT	0x49	Boolean	Boolean
	+	0x60	Integer, Integer	Integer
	-	0x61	Integer, Integer	Integer
	*	0x62	Integer, Integer	Integer
35	/	0x63	Integer, Integer	Integer
	{mod divide}	0x64	Integer, Integer	Integer
	{string concatenation}	0x70	String, String	String
40	{string extraction}	0x71	String, Integer, Integer	String
	{integer object access}	0x80	Integer, Integer, Integer	Integer
	{string object access}	0x81	Integer, Integer, Integer	String
	{boolean object access}		0x82	Integer, Integer, Integer Boolean
45	<u>Delimiters</u>			
	{end of string}	0x00		
	{end of statement list}	0x01		

Appendix C

## Predefined Resources

- Navigation & System: 20**
- 5 . Checkmark  
 . "X"  
 . "?"  
 . *i* in a blue circle  
 . Close icon: down arrow.
- 10 . Back arrow: 180 degree loop  
 . Right Arrow: 12 styles  
 . Padlock  
 . Magnifying glass
- Polls: 4**
- 15 . Thumbs up  
 . YES  
 . Thumbs down  
 . NO
- Payment/ Delivery/Ordering: 21**
- 20 . Visa card  
 . Mastercard  
 . American Express card  
 . Optima Card  
 . Discover card
- 25 . FedEx Logo  
 . UPS Logo  
 . DHL logo  
 . USPS logo  
 . Airborne Express logo
- 30 . Dollar Sign  
 . Phone  
 . Fax machine  
 . Coins  
 . Money bills
- 35 . Price tag  
 . Brochure  
 . Pen & paper  
 . Envelope  
 . Stamp
- 40 . Grocery cart
- Entertainment: 10**
- . Television  
 . Admission ticket  
 . Musical notes
- 45 . CD  
 . Audio Cassette  
 . Video Cassette  
 . film strip  
 . film camera/projector
- 50 . Knife & fork  
 . Wine bottle & glass
- News/Info: 19**
- . Watch

WO 96/34466

PCT/US96/04819

- . Clock
- . Alarm clock
- . Globe
- . USA map
- 5 . Newspaper
- . US flag
- . Capitol dome
- . stock grid
- . car
- 10 . airplane
- . van
- . train
- . bus
- . Book
- 15 . Calendar
- . Suitcase
- . Beakers
- . Nuclear energy symbol
- Weather/Almanac: 17**
- 20 . Sun
- . Cloud
- . Sun w/cloud
- . Cloud w/rain
- . Rain drops
- 25 . Cloud w/snow
- . Snowflake
- . Lightning
- . Tornado
- . Hurricane
- 30 . Fog
- . Full Moon
- . Last Quarter
- . New Moon
- . First Quarter
- 35 . Waves
- . Thermometer
- Sports: 18**
- . Skier
- . Referees whistle
- 40 . Combo sports image: baseball, football, basketball
- . Soccer ball
- . Baseball
- . Official baseball logo
- . Football
- 45 . NFL logo
- . Basketball
- . NBA logo
- . Ice skates
- . Hockey puck & stick
- 50 . Bowling ball & bowling pins
- . Tennis racquet
- . Golf putter, golf ball, and tee
- . Sailboat
- . Boxing gloves
- 55 . Horse
- Misc: 7**
- . Key

WO 96/34466

PCT/US96/04819

- . Lightbulb
- . Graduation cap
- . Construction hard hat
- . Picture (photograph)
- 5 . Road work sign
- . Rose

What is claimed is:

1. A graphical interactive information system for broadcasting and receiving graphical interactive information system applications having a graphical user interface comprising:
  - 5 a provider component for broadcasting graphical interactive information system application information, the provider component comprising:
    - a protocol generator and formatter having an input for accepting information from an information provider, for generating, formatting and presenting at an output a protocol for a graphical interactive information system application corresponding to the information input from the information provider;
    - 10 a protocol inserter having a first input coupled to the protocol generator and formatter output, for inserting the protocol into a broadcast signal and presenting at an output the broadcast signal containing the inserted protocol; and
    - a transmitter having an input coupled to the protocol inserter output, for broadcasting the broadcast signal containing the inserted protocol; and
    - 15 a reception component for receiving the graphical interactive information system application information broadcast, displaying the graphical interactive information system application user interface and operating the graphical interactive information system application.
- 20 2. The system of claim 1 wherein the transmitter comprises an FM transmitter.
3. The system of claim 1 wherein the transmitter comprises a pager transmitter.
4. The system of claim 1 wherein the transmitter comprises a cellular telephone transmitter.
- 25 5. The system of claim 1 wherein the transmitter comprises a television transmitter.

6. The system of claim 1 wherein the transmitter comprises a cable television head-end amplifier.

7. The system of claim 1 wherein the transmitter comprises an out-of-band transmitter.

5 8. The system of claim 1 wherein the data inserter comprises a VBI data inserter.

9. The system of claim 1 wherein:  
the provider component additionally comprises a program generator for generating at an output a broadcast signal; and  
10 the protocol inserter additionally has a second input coupled to the program generator output, for receiving the broadcast signal into which the protocol is inserted.

10. The system of claim 9 wherein the transmitter comprises a television transmitter.

15 11. The system of claim 9 wherein the transmitter comprises a cable television head-end amplifier.

12. A graphical interactive information system for broadcasting and receiving graphical interactive information system applications having a graphical user interface comprising:

20 a provider component for broadcasting graphical interactive information system application information; and

a reception component for receiving the graphical interactive information system application information broadcast, displaying the graphical interactive information system application user interface and operating the graphical  
25 interactive information system application, the reception component comprising:

a first tuner for receiving a broadcast signal and tuning at least one desired frequency at an output;

a data extractor coupled to the first tuner output for extracting a graphical interactive information system application from the desired frequency;

a microprocessor coupled to the data extractor output for controlling the operation of the reception component and interpreting interactive information system application commands and scripts;

a graphics display generator having a first input coupled to the microprocessor for generating at an output a graphical user interface display signal; and

a storage device coupled to the microprocessor for storing interactive information system application information.

13. The system of claim 12 wherein the graphics display generator has a second input coupled to the first tuner, and the graphics display generator is also for displaying a broadcast program.

14. The system of claim 12 wherein the reception component additionally comprises a user input receiver having an output, for receiving input from a user.

15. The system of claim 14 wherein the user input receiver comprises a keypad.

16. The system of claim 14 wherein the user input receiver comprises an infrared receiver.

17. The system of claim 14 wherein the reception component additionally comprises a user input decoder having an input coupled to the user input receiver input and an output coupled to the microprocessor, for decoding input commands from a user.

18. The system of claim 12 further comprising a display coupled to the graphics display generator for displaying the output thereof, the display comprising a television set.

19. The system of claim 12 further comprising a display coupled to the graphics display generator for displaying the output thereof, the display comprising an LCD display.

20. The system of claim 12 wherein the first tuner is additionally coupled to the microprocessor for allowing the microprocessor to control the tuned frequency of the first tuner.

21. The system of claim 12 wherein the first tuner is additionally coupled to the microprocessor for allowing the microprocessor to determine information relating to available frequencies in the first tuner.

22. The system of claim 12 wherein the broadcast signal comprises a broadcast program having a content related to a content of the interactive information system application.

23. The system of claim 22 wherein the data extractor extracts the interactive information system application from the vertical blanking interval.

24. The system of claim 12 wherein the broadcast signal comprises a broadcast advertisement having content related to a content of the interactive information system application.

25. The system of claim 24 wherein the data extractor extracts the interactive information system application from the vertical blanking interval.

26. The system of claim 12 wherein the reception component additionally comprises an infrared emitter having an input for controlling an external device.

27. The system of claim 26 wherein the reception component additionally comprises an infrared encoder having an input coupled to the microprocessor and an output coupled to the infrared emitter input for encoding microprocessor commands into infrared signals compatible with the external device.

28. The system of claim 12 wherein the reception component additionally comprises a data line driver having an input coupled to the microprocessor and an output for allowing the microprocessor to communicate with an external device.

29. The system of claim 28 wherein the data line driver is a modem.

5 30. The system of claim 28 wherein the data line driver is a DTMF tone dialer.

31. The system of claim 28 wherein the data line driver is an addressable CATV set-top converter controller.

32. The system of claim 12 wherein the reception component additionally  
10 comprises a second tuner for receiving a broadcast signal and tuning a second desired frequency comprising a broadcast program at its output; and  
the graphics display generator has a second input coupled to the second tuner, and the graphics display generator is also for displaying a broadcast program.

33. The system of claim 32 wherein the first tuner is additionally coupled  
15 to the microprocessor for allowing the microprocessor to control the tuned frequency of the first tuner.

34. The system of claim 32 wherein the first tuner is additionally coupled to the microprocessor for allowing the microprocessor to determine information relating to available frequencies in the first tuner.

20 35. The system of claim 32 wherein the interactive information system application comprises a content related to a content of the broadcast program.

36. The system of claim 35 wherein the data extractor extracts the interactive information system application from an out-of-band frequency.

25 37. The system of claim 35 wherein the data extractor extracts the interactive information system application from an FM frequency.

38. In a system including a plurality of reception components having defined display capabilities, at least two of the plurality of reception components having different display capabilities, a method of providing a graphical interactive information application for display to, and control by, a user, comprising the steps of:

- 5           broadcasting at least one graphical object definition record comprising hint information describing optional image characteristics of a graphical object;  
               receiving the broadcast graphical object definition record and hint information at each of the plurality of reception components; and  
               creating different graphical interactive information displays on ones of  
 10 the plurality of reception components having different display capabilities based upon the broadcast graphical object definition record and using the hint information to selectively display the graphical object with the optional image characteristics supported by the capabilities of the reception components.

39. The method of claim 38, wherein the broadcast at least one graphical  
 15 object definition record comprises a form object definition record.

40. The method of claim 39, wherein the form object definition record comprises hint information describing one or more image characteristics selected from the group consisting of:

- foreground color;  
 20           background color;  
               border color;  
               border style;  
               border width;  
               border options;  
 25           form transition effect;  
               form background gradient fill;  
               clip;  
               scale to fit;  
               scale;  
 30           text private;  
               text numeric; and  
               text editable.

41. The method of claim 38, wherein the broadcast at least one graphical object definition record comprises a button object definition record.

42. The method of claim 41, wherein the button object definition record comprises hint information describing a legend appearing on a button.

5 43. The method of claim 38, wherein the broadcast at least one graphical object definition record comprises a text object definition record.

44. The method of claim 38, wherein the broadcast at least one graphical object definition record comprises a bitmap object definition record.

10 45. The method of claim 38, wherein the broadcast at least one graphical object definition record comprises a picture object definition record.

46. The method of claim 38, wherein the broadcast at least one graphical object definition record comprises a list object definition record.

15 47. The method of claim 46, wherein the list object definition record comprises hint information describing one or more image characteristics selected from the group consisting of:

highlight color;

list exclusive;

list exclusive none;

list non exclusive;

20 list horizontal;

list vertical;

list sort ascending;

list sort descending;

list control up;

25 list control down;

list control left; and

list control right.

48. The method of claim 38, wherein the broadcast at least one graphical object definition record comprises a cursor object definition record.

49. The method of claim 48, wherein the cursor object definition record comprises hint information describing whether a box is displayed.

5 50. In a system including first and second reception components having different display capabilities, a method of decoding a broadcast signal comprising the steps of:

receiving the broadcast signal at the first and second reception components;

10 extracting at the first and second reception components an executable graphical interactive information system application including at least one image and hint information describing optional characteristics of the image;

executing the graphical interactive information system application on the first reception component to generate the at least one image for display on a first display device coupled to the first reception component;

15 executing the graphical interactive information system application on the second reception component to generate the at least one image for display on a second display device coupled to the second reception component;

20 selectively adapting the generation of the at least one image to the display device of the first reception component based upon the hint information and the display capabilities of the first reception component; and

25 selectively adapting the generation of the at least one image to the display device of the second reception component based upon the hint information and the display capabilities of the second reception component, wherein the at least one image displayed on the first display device is different than the at least one image displayed on the second display device.

51. The method of claim 50, further comprising:  
determining, from the interactive application, how a user may respond to the system application.

30 52. The method of claim 51, further comprising:

receiving a response from the user; and  
 sending the response to a response collector, wherein an identity of the  
 response collector is determined from the interactive application.

53. The method of claim 50, wherein extracting comprises:  
 5 extracting an application header record from the broadcast signal;  
 determining, from the application header record, a format of  
 information transmitted within the broadcast signal.

54. The method of claim 50, further comprising:  
 extracting error code information from the broadcast signal;  
 10 analyzing the error code information to detect a broadcast error; and  
 halting the generation of the at least one image in response to the  
 detection of a broadcast error.

55. The method of claim 50, further comprising storing the graphical  
 interactive information system application in a memory.

15 56. The method of claim 50, wherein the at least one image is a form and  
 the hint information describes one or more image characteristics selected from the  
 group consisting of:

foreground color;  
 background color;  
 20 border color;  
 border style;  
 border width;  
 border options;  
 transition effect;  
 25 background gradient fill;  
 clip;  
 scale to fit;  
 scale;  
 text private;  
 30 text numeric; and

text editable.

57. The method of claim 50, wherein the at least one image is a button and the hint information describes optional characteristics of a legend appearing on the button.

5 58. The method of claim 50, wherein the wherein the at least one image is a list and the hint information describes one or more image characteristics selected from the group consisting of:

highlight color;

list exclusive;

10 list exclusive none;

list non exclusive;

list horizontal;

list vertical;

list sort ascending;

15 list sort descending;

list control up;

list control down;

list control left; and

list control right.

20 59. The method of claim 50, wherein the at least one image is a cursor and the broadcast at least one graphical object definition record comprises a cursor and the hint information describes whether a box is displayed.

60. A method for providing a graphical interactive information application describing at least one image to a plurality of reception components having defined display capabilities, at least two of the plurality of reception components having different display capabilities, the method comprising the step of:

25

broadcasting at the least one graphical object definition record describing at least one image and comprising hint information describing optional characteristics of the at least one image to the plurality of reception components;

wherein ones of the plurality of reception components having different display capabilities create different graphical interactive information displays based upon the broadcast graphical object definition record and using the hint information to selectively display optional characteristics of the at least one image supported by the  
5 reception components.

61. In a system including a plurality of reception components, each reception component having display capabilities, a method of providing a graphical interactive application comprising:

receiving a broadcast signal at a first reception component, the  
10 broadcast signal including a graphical interactive application containing at least one graphical object definition record comprising hint information describing optional image characteristics of a graphical object;

extracting the graphical interactive application from the broadcast signal at the first reception component; and

15 executing the graphical interactive application on the first reception component to generate at least one image for display on a display device coupled to the first reception component, by using the hint information of the graphical object definition record to selectively display the graphical object in the at least one image with the optional image characteristics supported by the capabilities of the reception  
20 component.

62. A method of executing a broadcast graphical interactive application by a reception component, the method comprising:

storing a plurality of standardized graphical objects in the reception component;

25 receiving in the reception component via a broadcast signal, an application header record for the graphical application describing characteristics of the graphical application including an application identifier and data descriptive of a number of records in the graphical application;

receiving in the reception component via the broadcast signal graphical  
30 object definition records and script records of the graphical application in any order after receiving an application header record, the graphical object definition records describing graphic objects to be displayed using the standardized graphical objects

stored in the reception component, the script records describing steps to be performed by the graphical application;

determining that all records of the graphical application have been received; and

5 responsive to all records of the graphical application having been received, executing the graphical application, including selectively displaying graphical objects using the stored graphical objects and the graphical object definition records, and executing the steps in the script records.

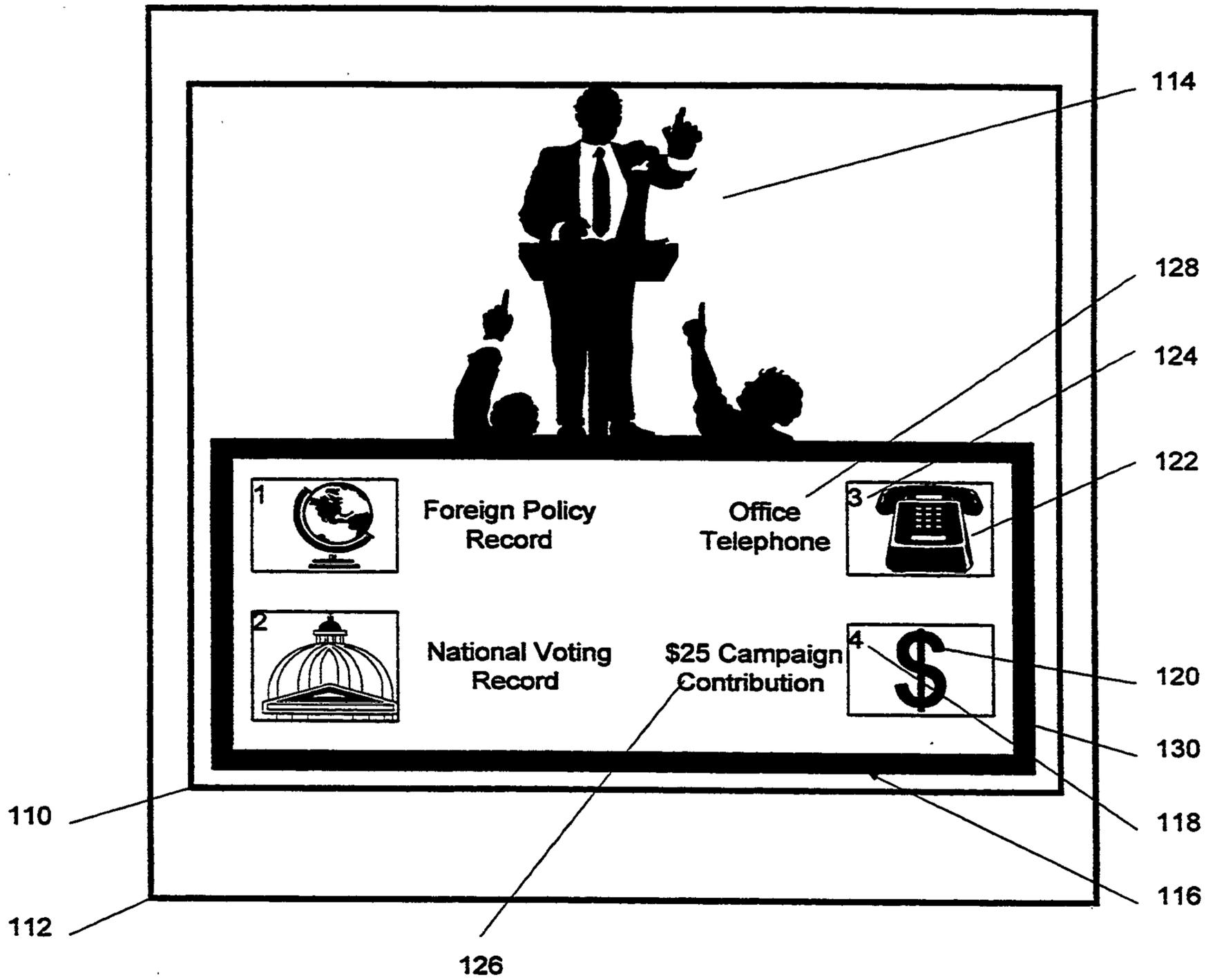

Fig. 1

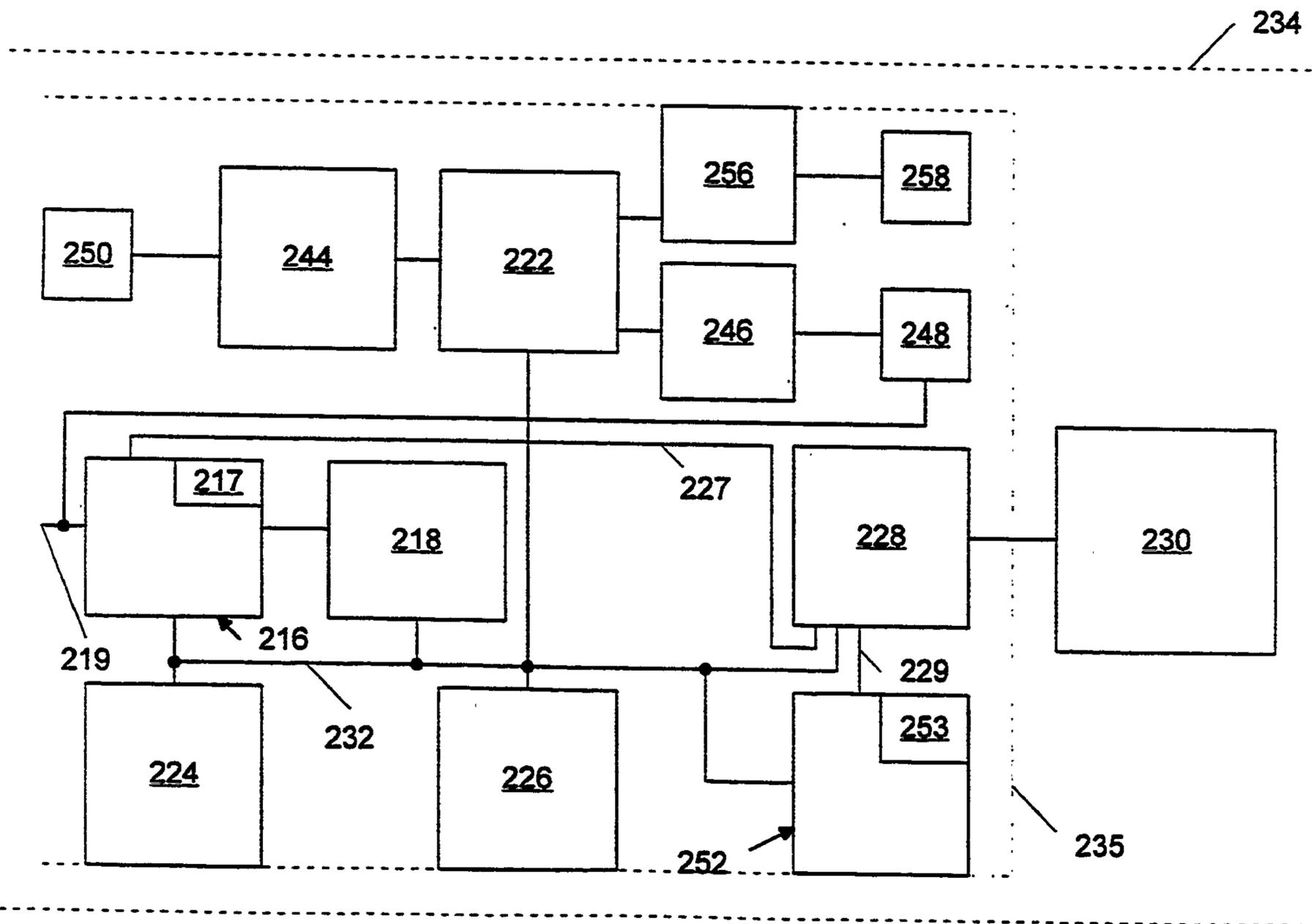
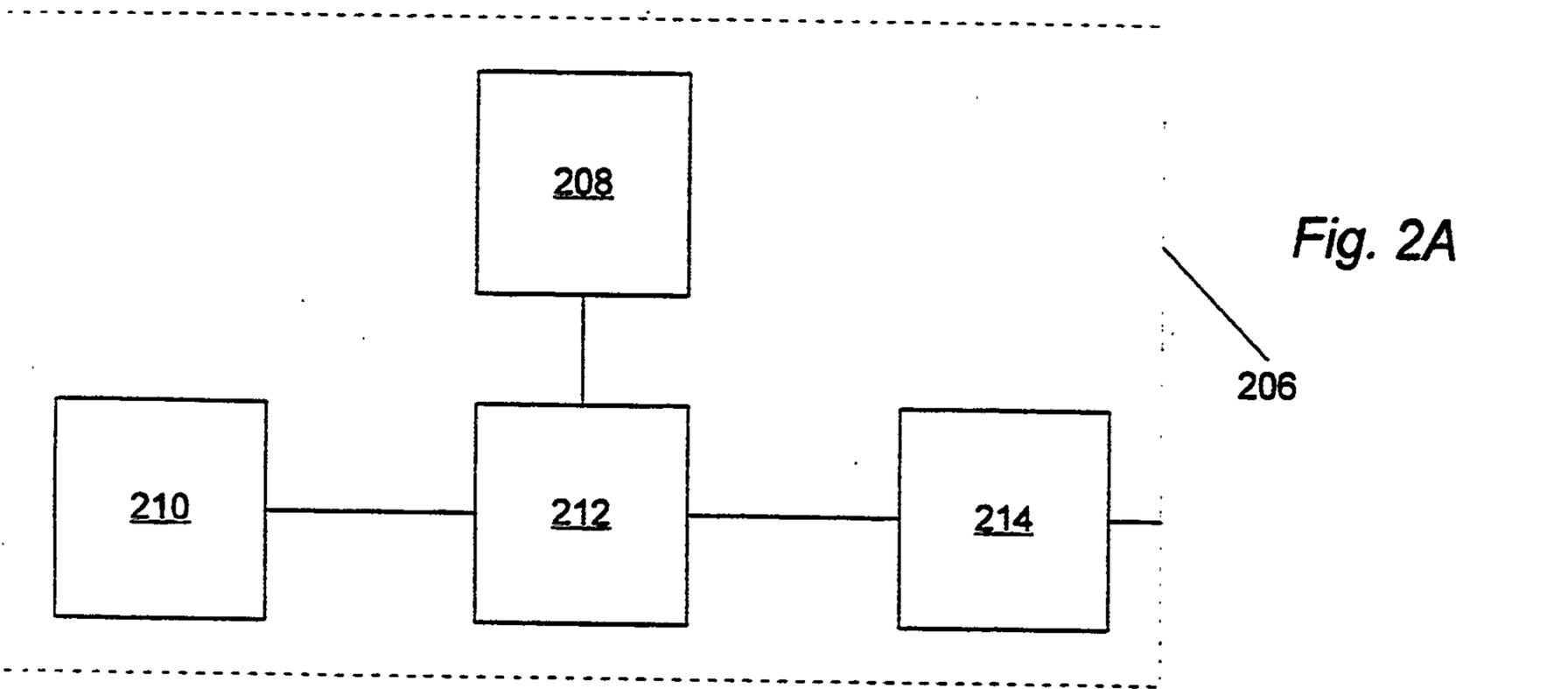

Fig. 2B

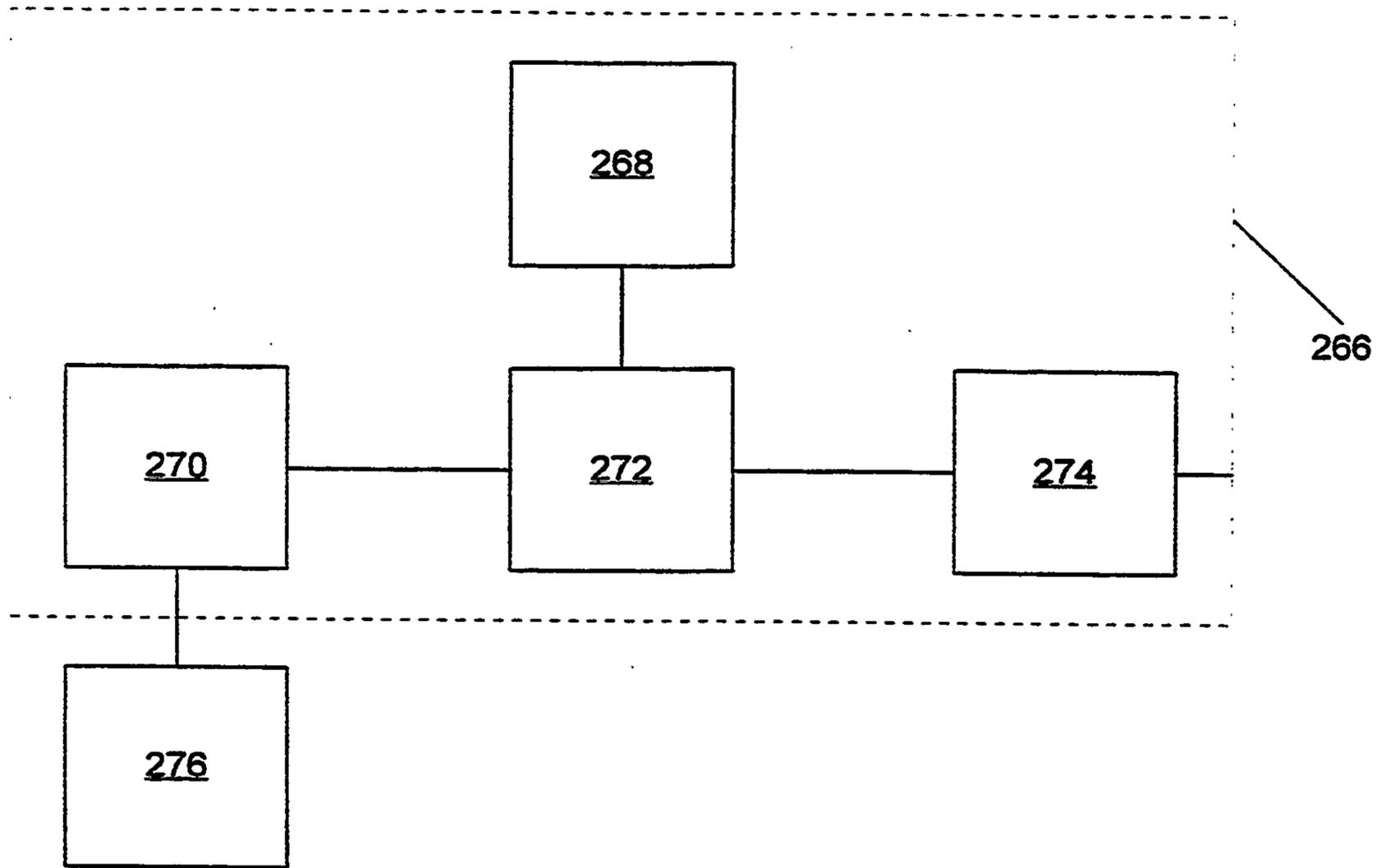

Fig. 2C

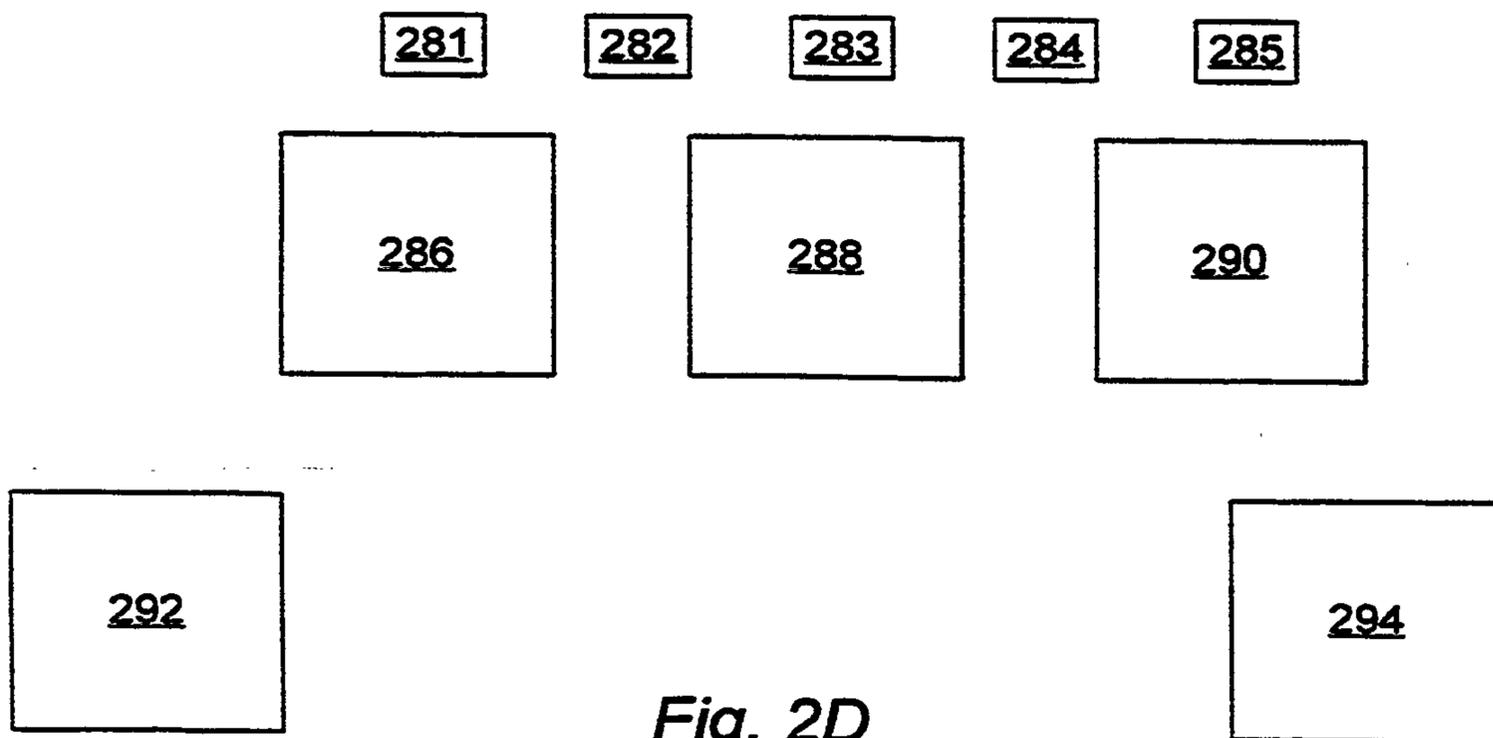

Fig. 2D

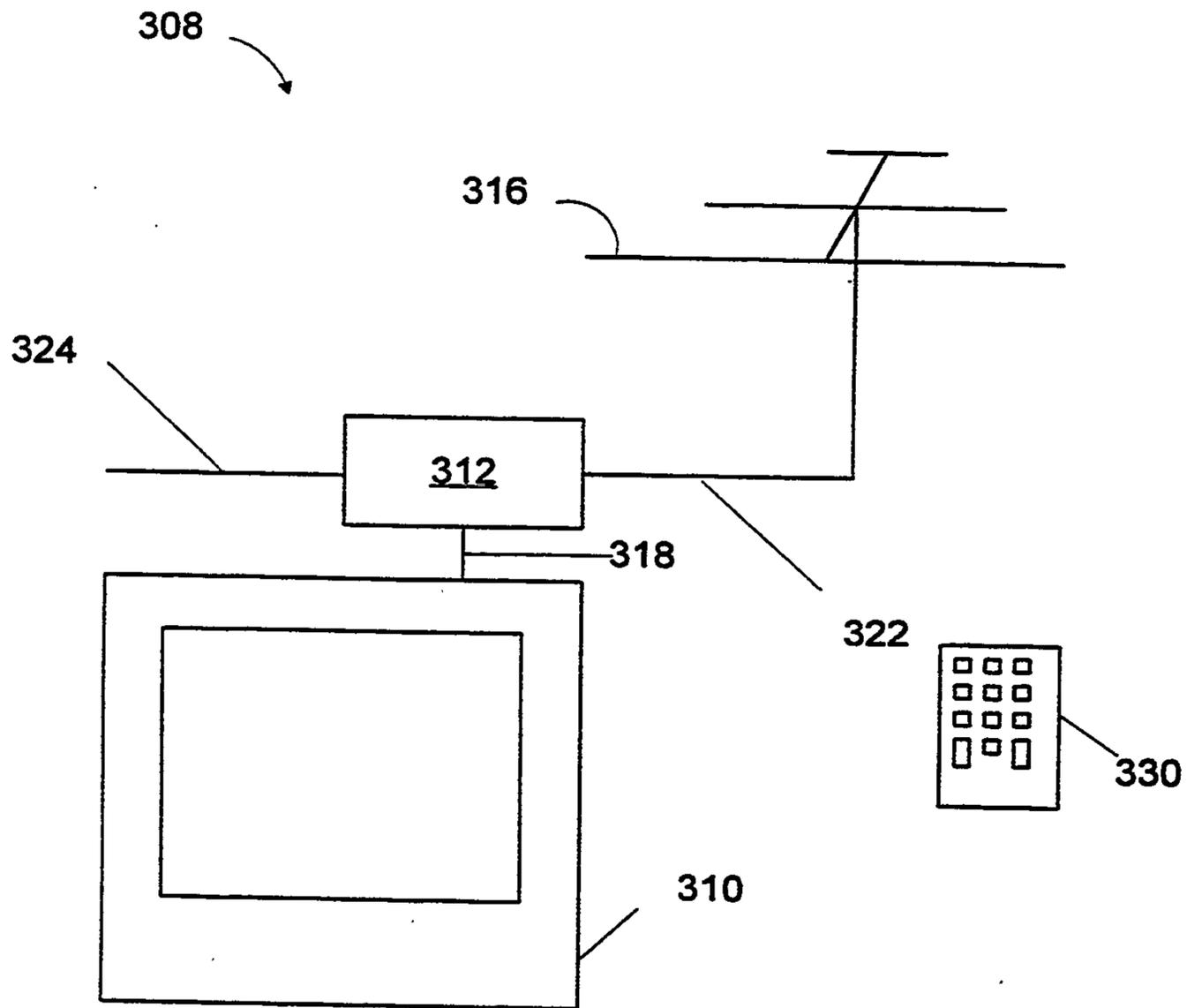

Fig. 3

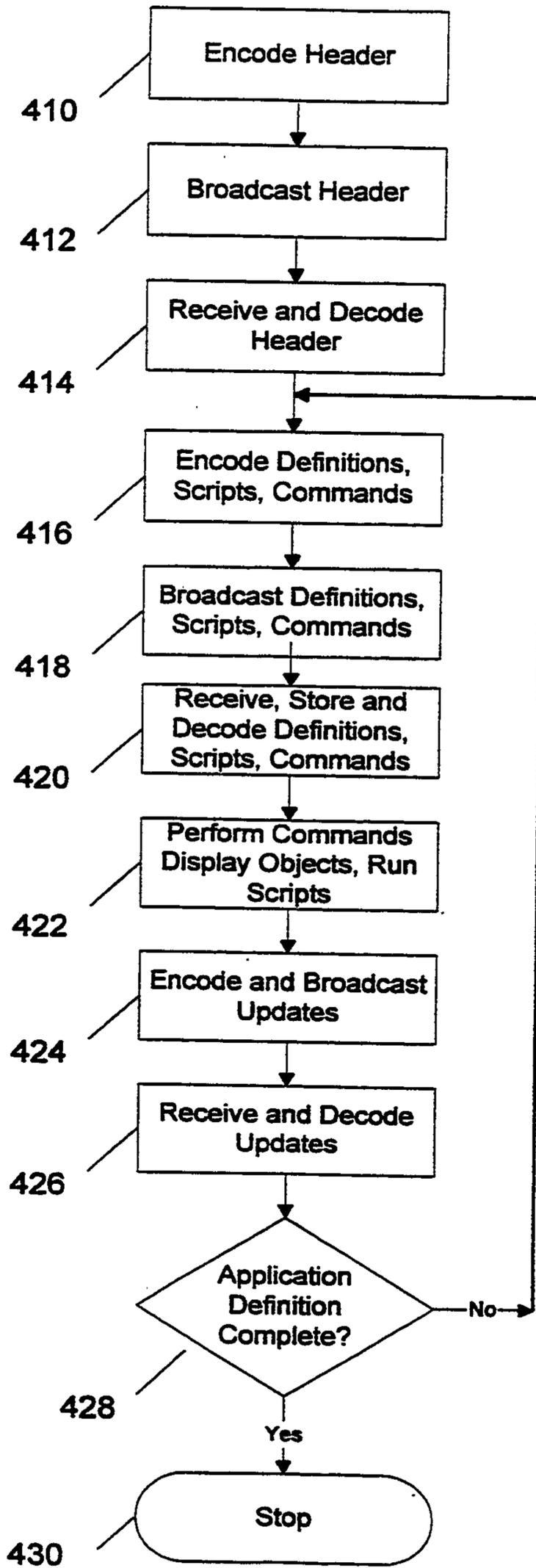
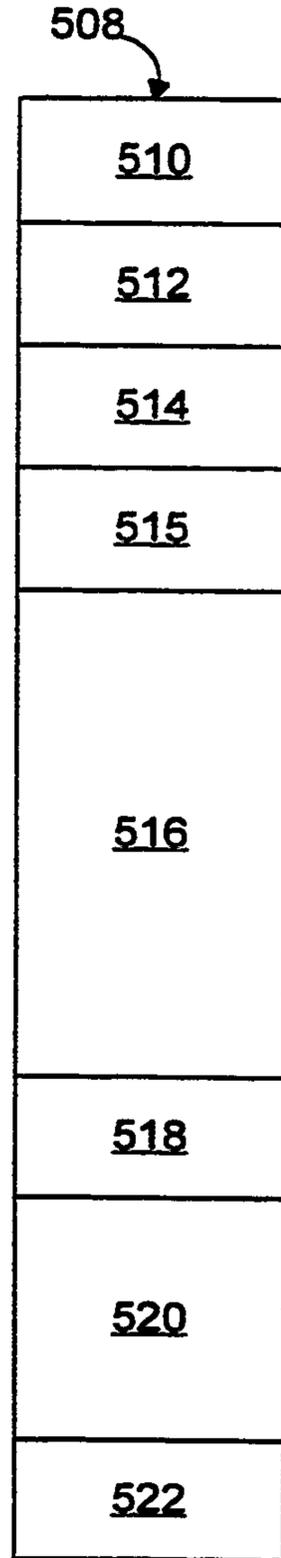
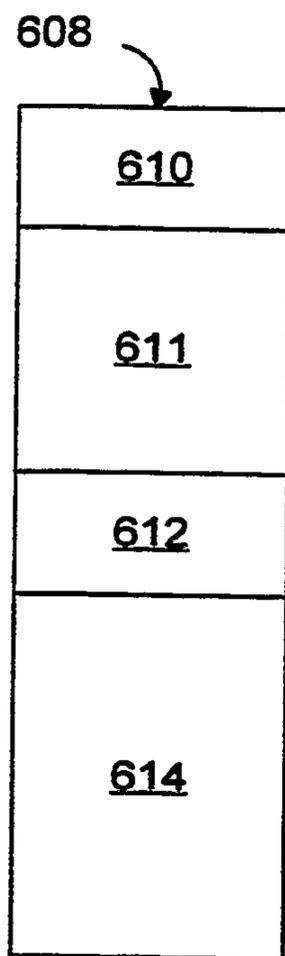

Fig. 4

6/25



*Fig. 5*



*Fig. 6*

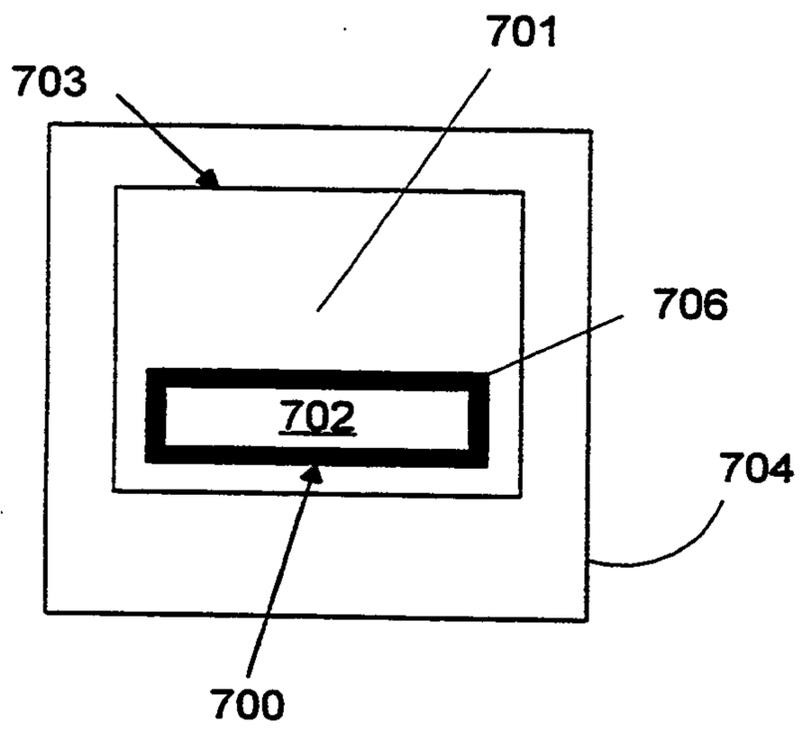

*Fig. 7A*

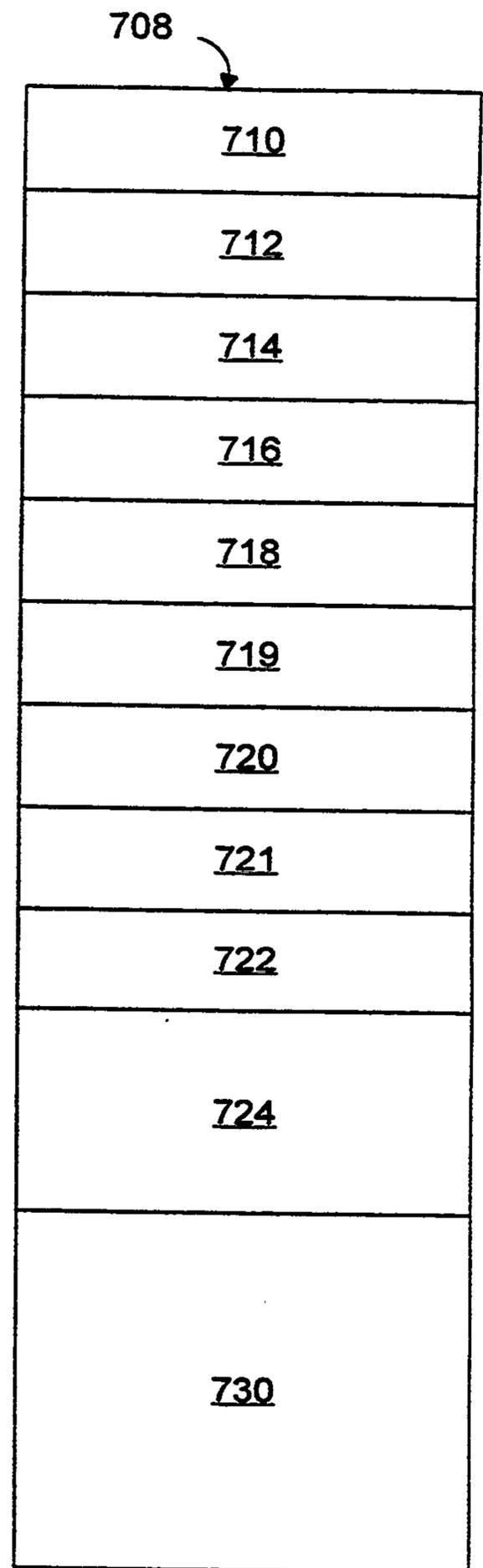

*Fig. 7B*

9/25

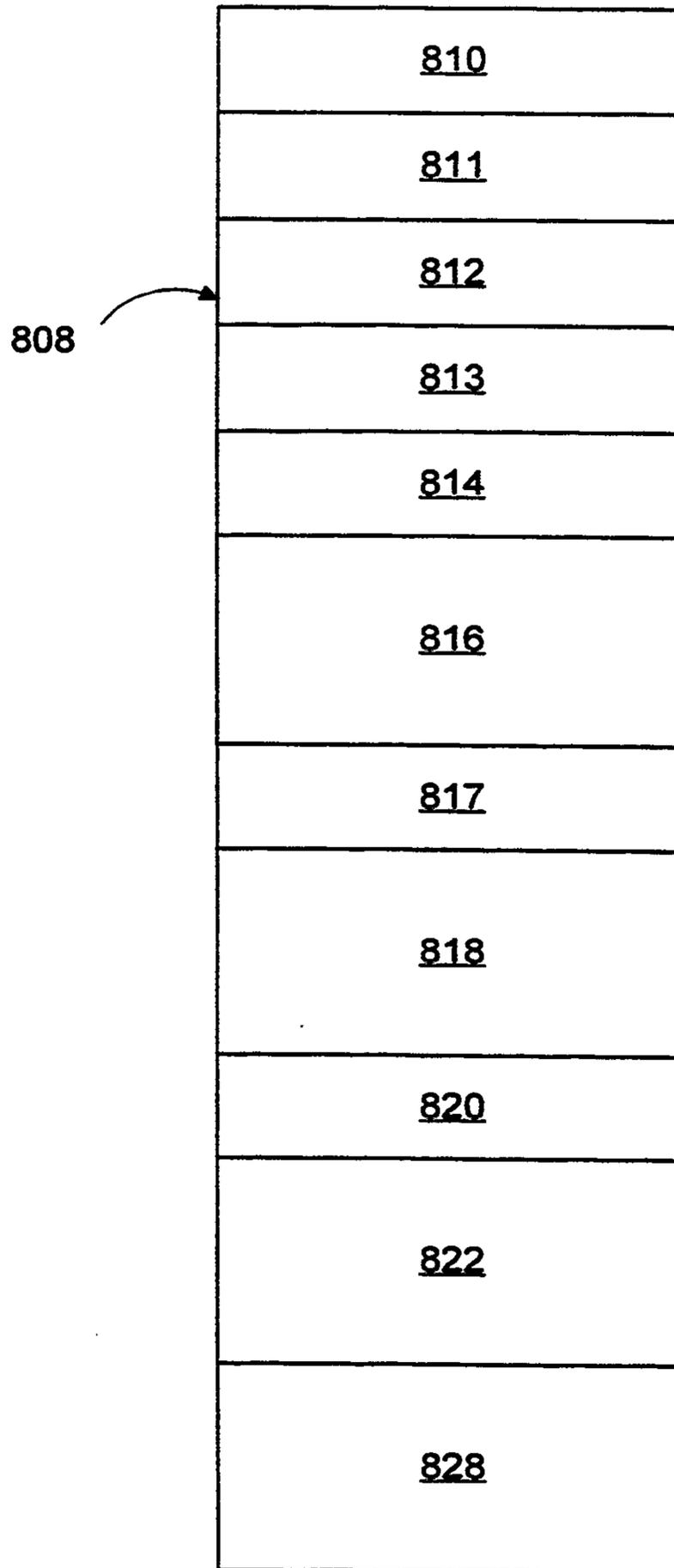
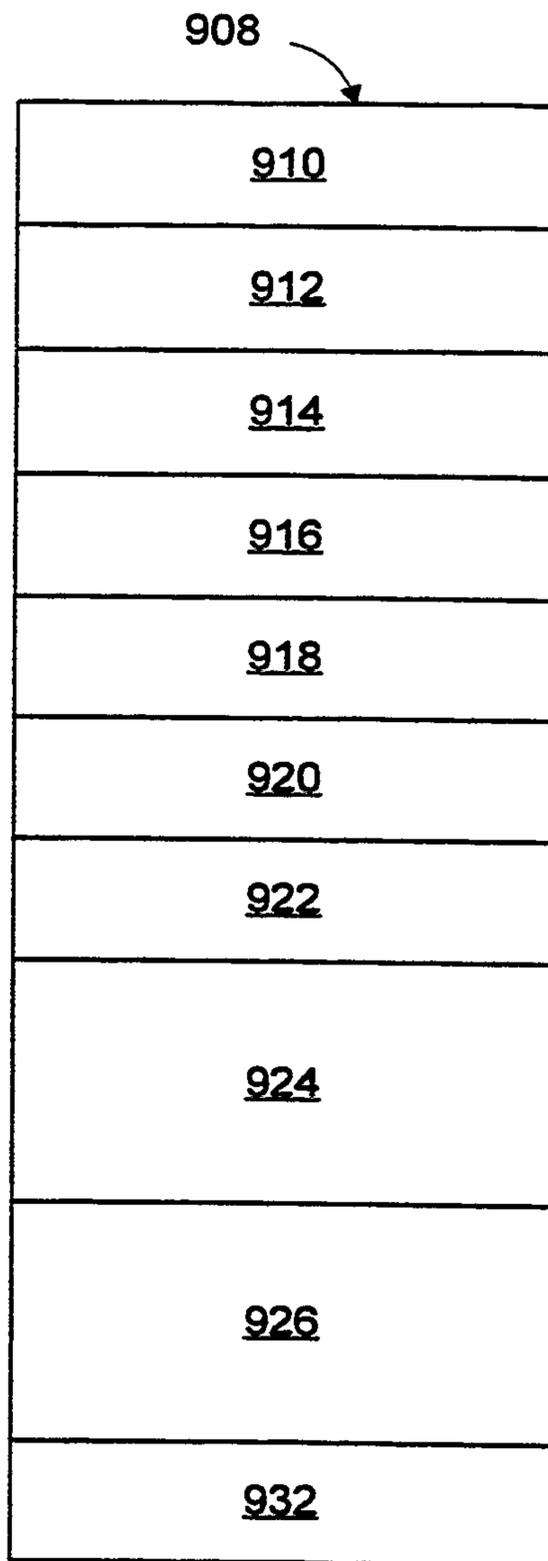

Fig. 8

10/25



*Fig. 9*

11/25

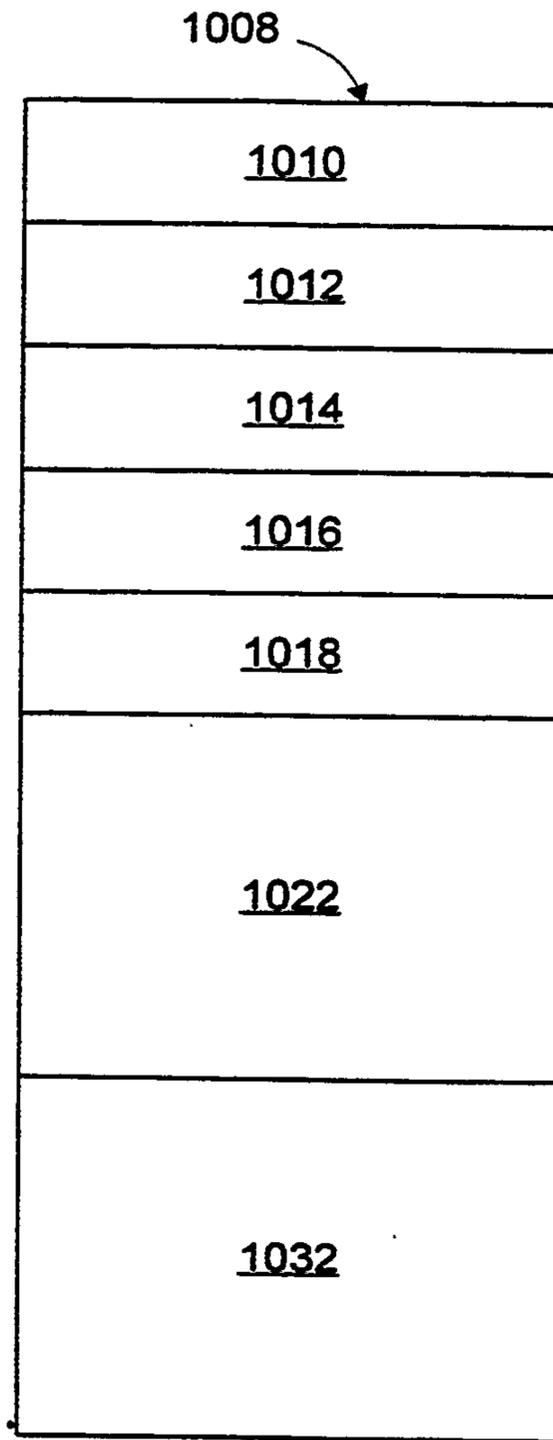

*Fig. 10*

12/25

1108

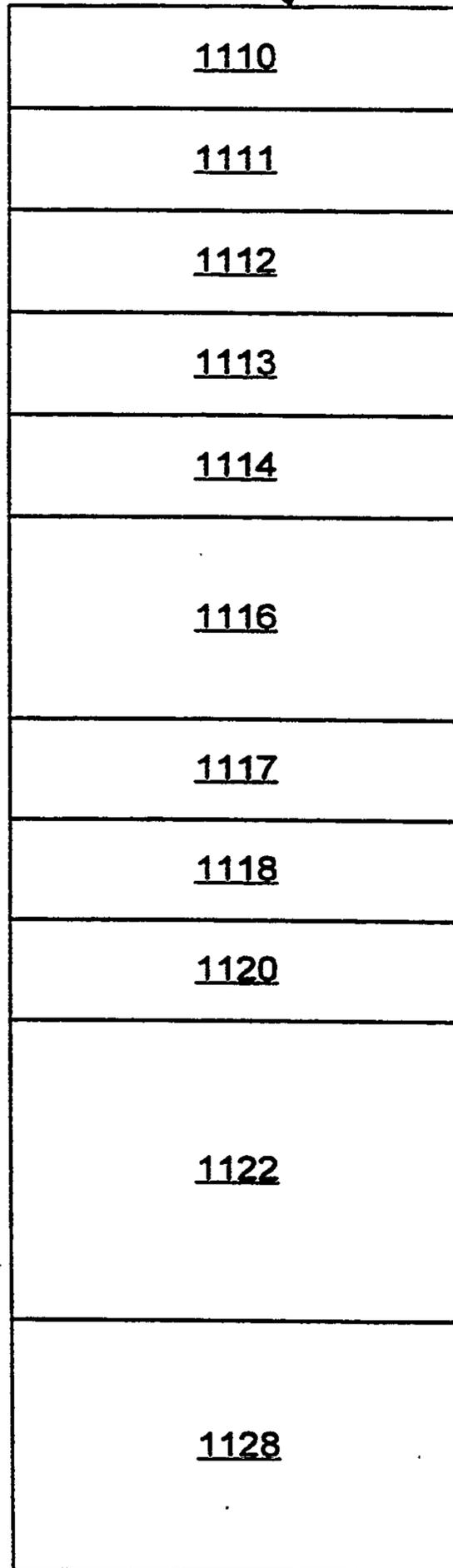

*Fig. 11*

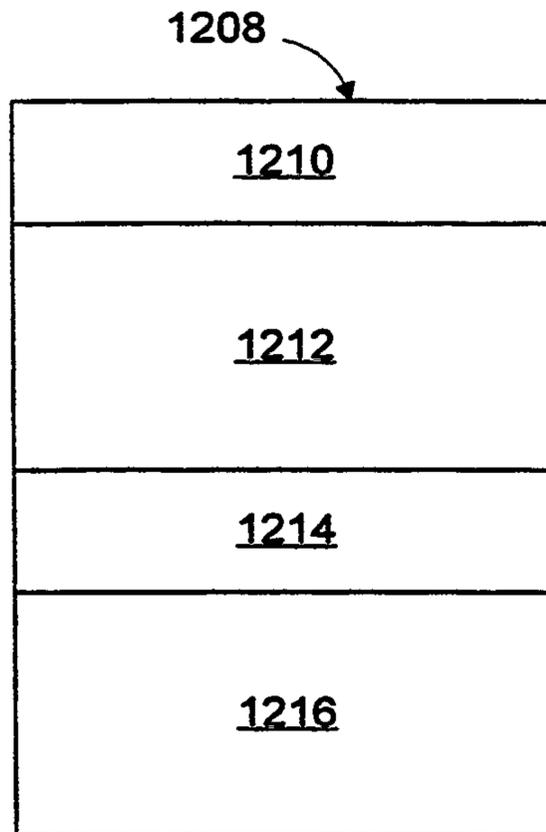

*Fig. 12*

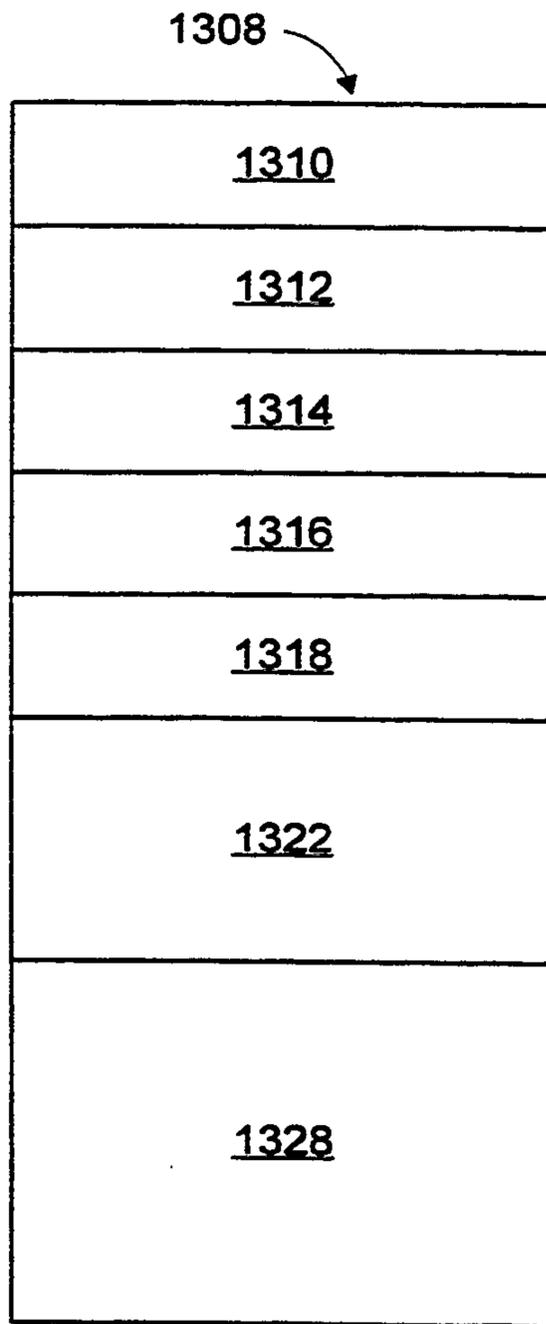

*Fig. 13*

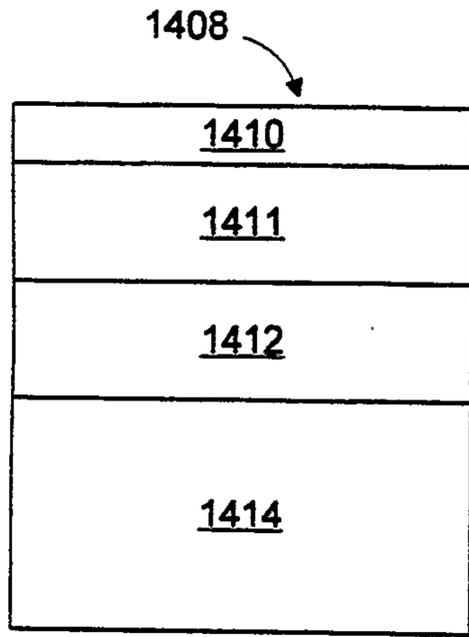

*Fig. 14A*

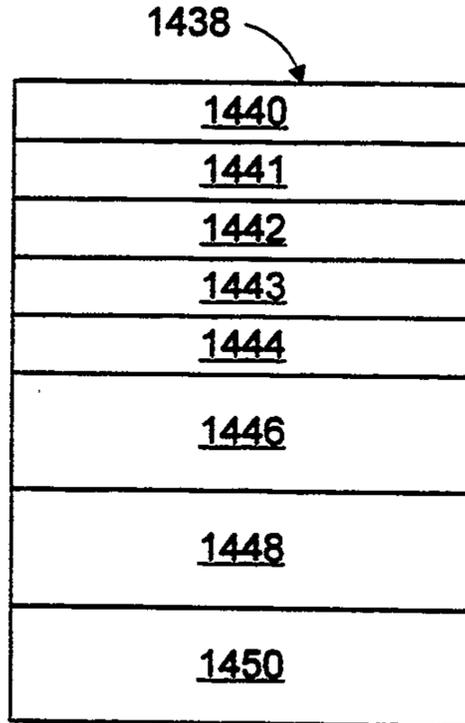

*Fig. 14C*

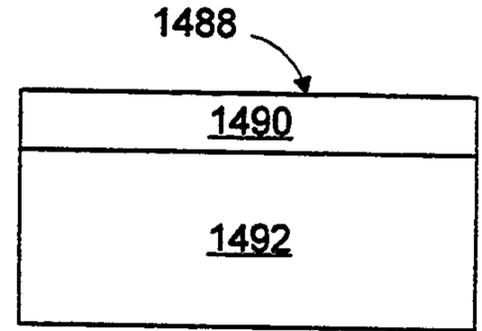

*Fig. 14F*

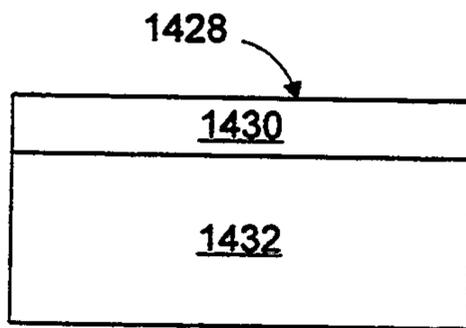

*Fig. 14B*

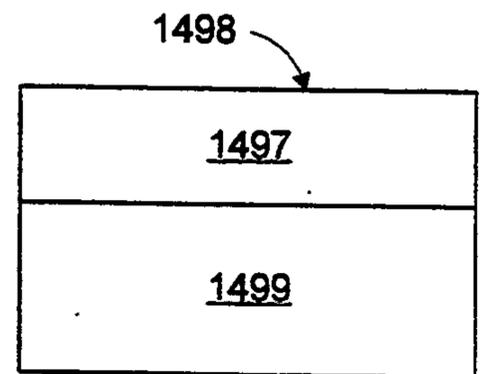

*Fig. 14G*

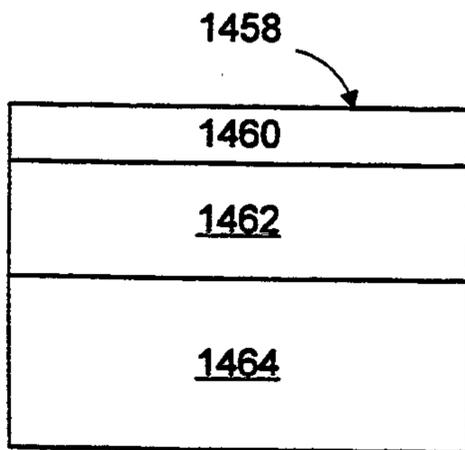

*Fig. 14D*

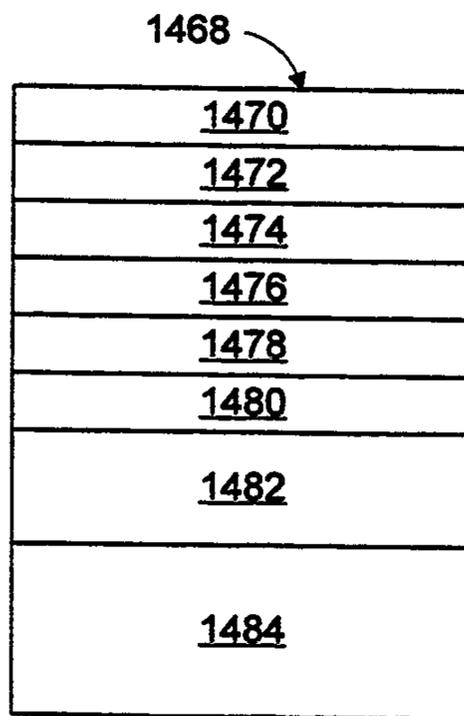

*Fig. 14E*

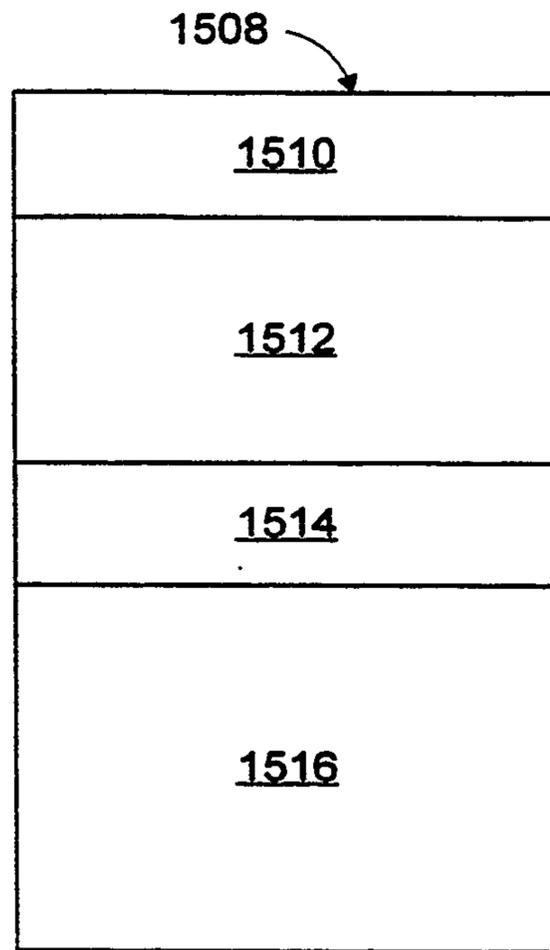

*Fig. 15*

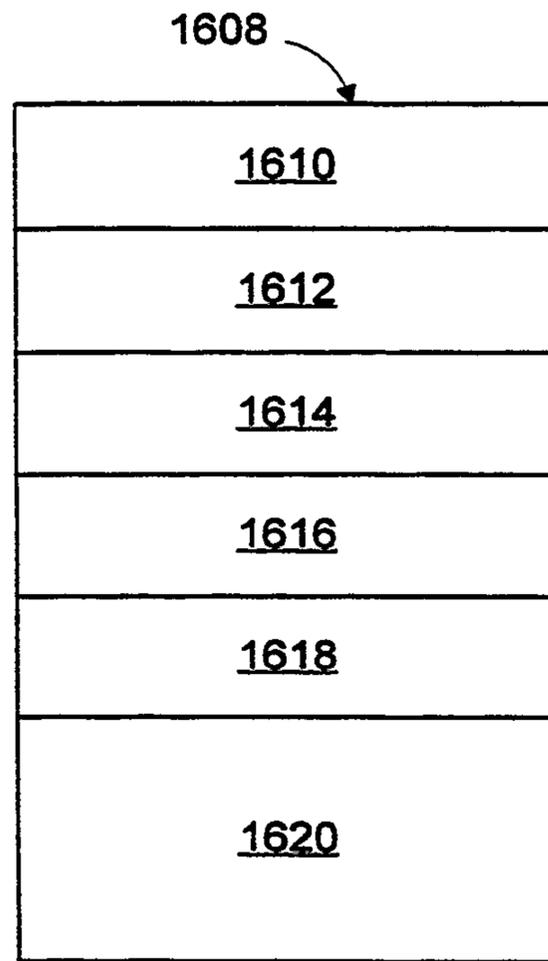

*Fig. 16*

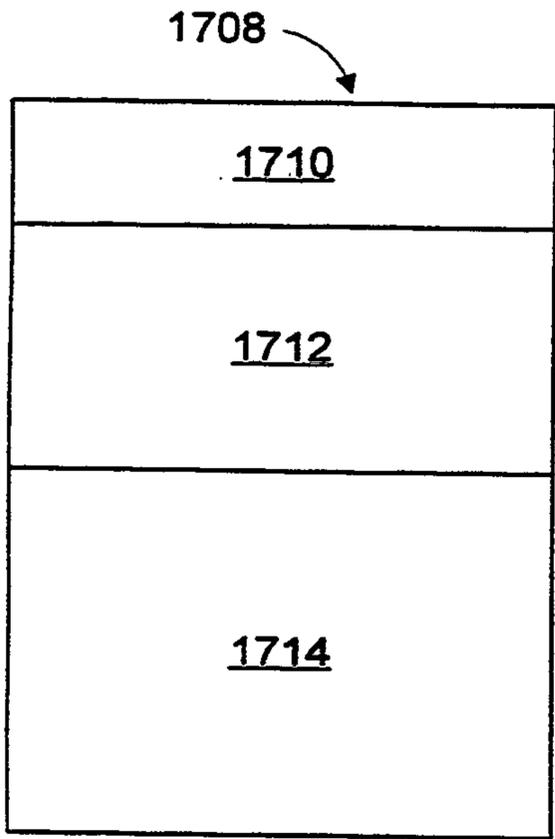

*Fig. 17A*

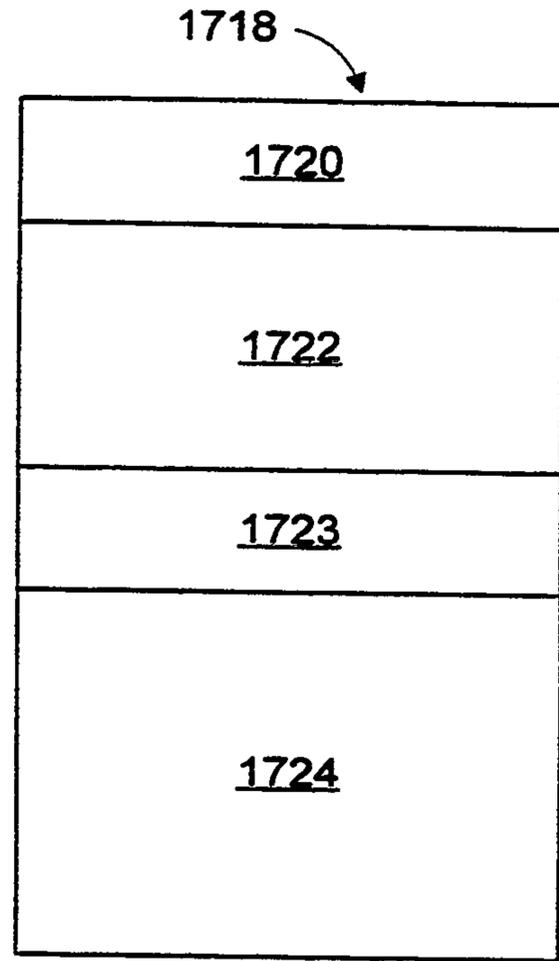

*Fig. 17B*

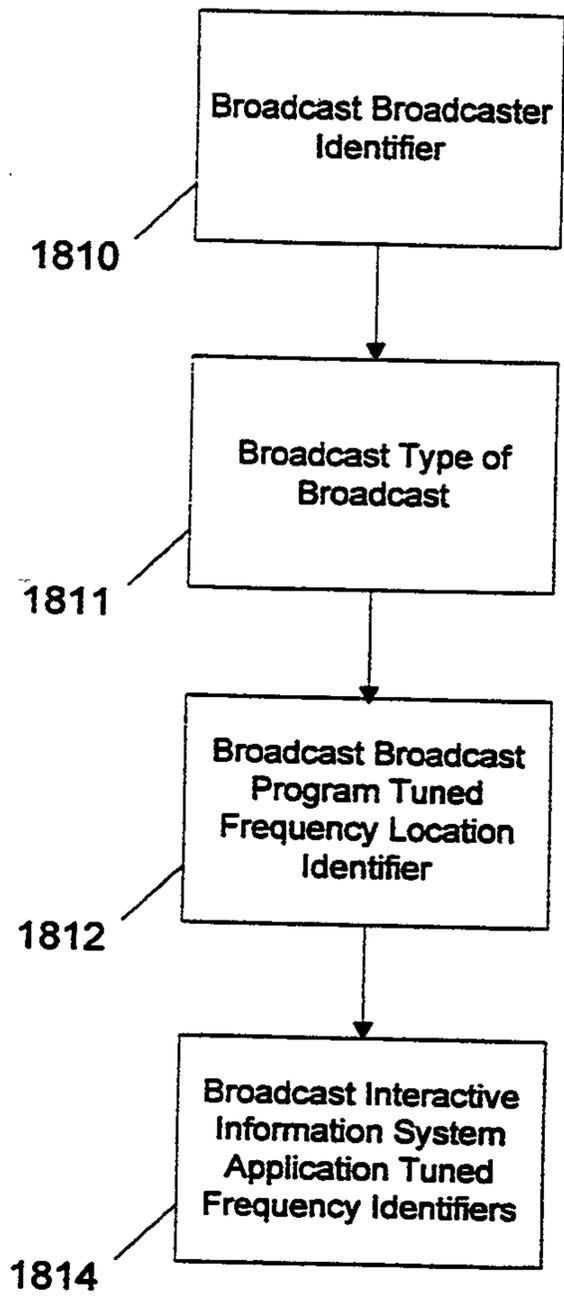

*Fig. 18A*

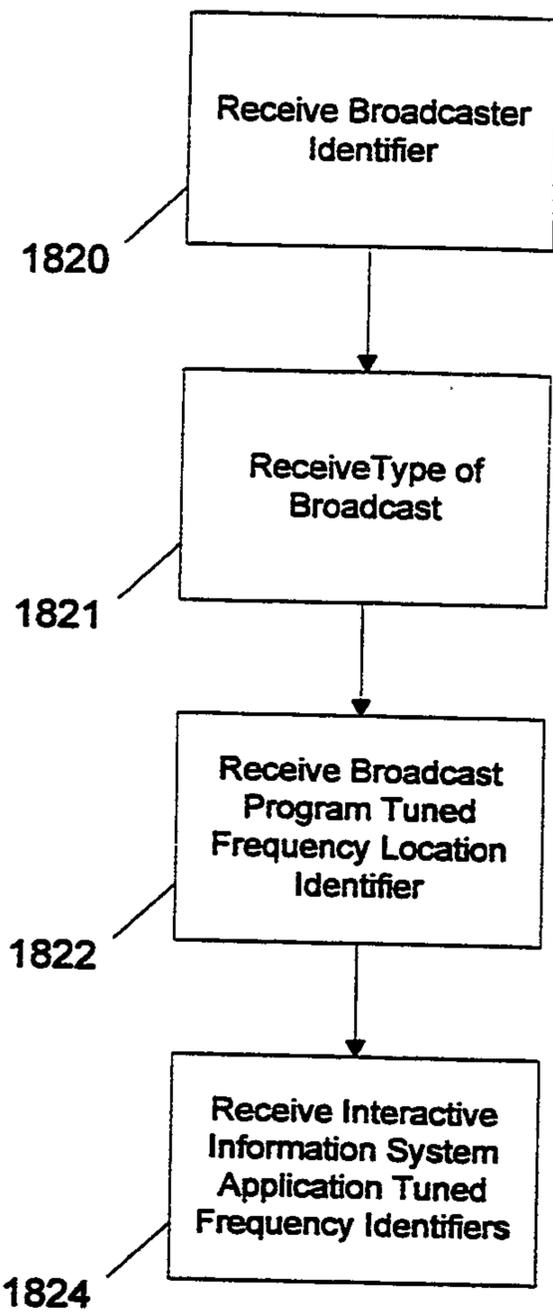

*Fig. 18B*

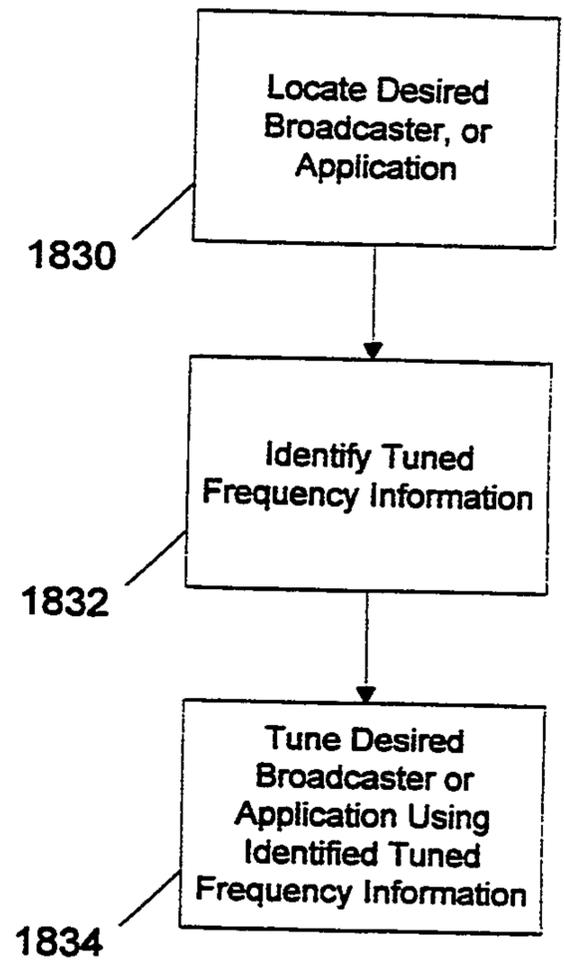

*Fig. 18C*

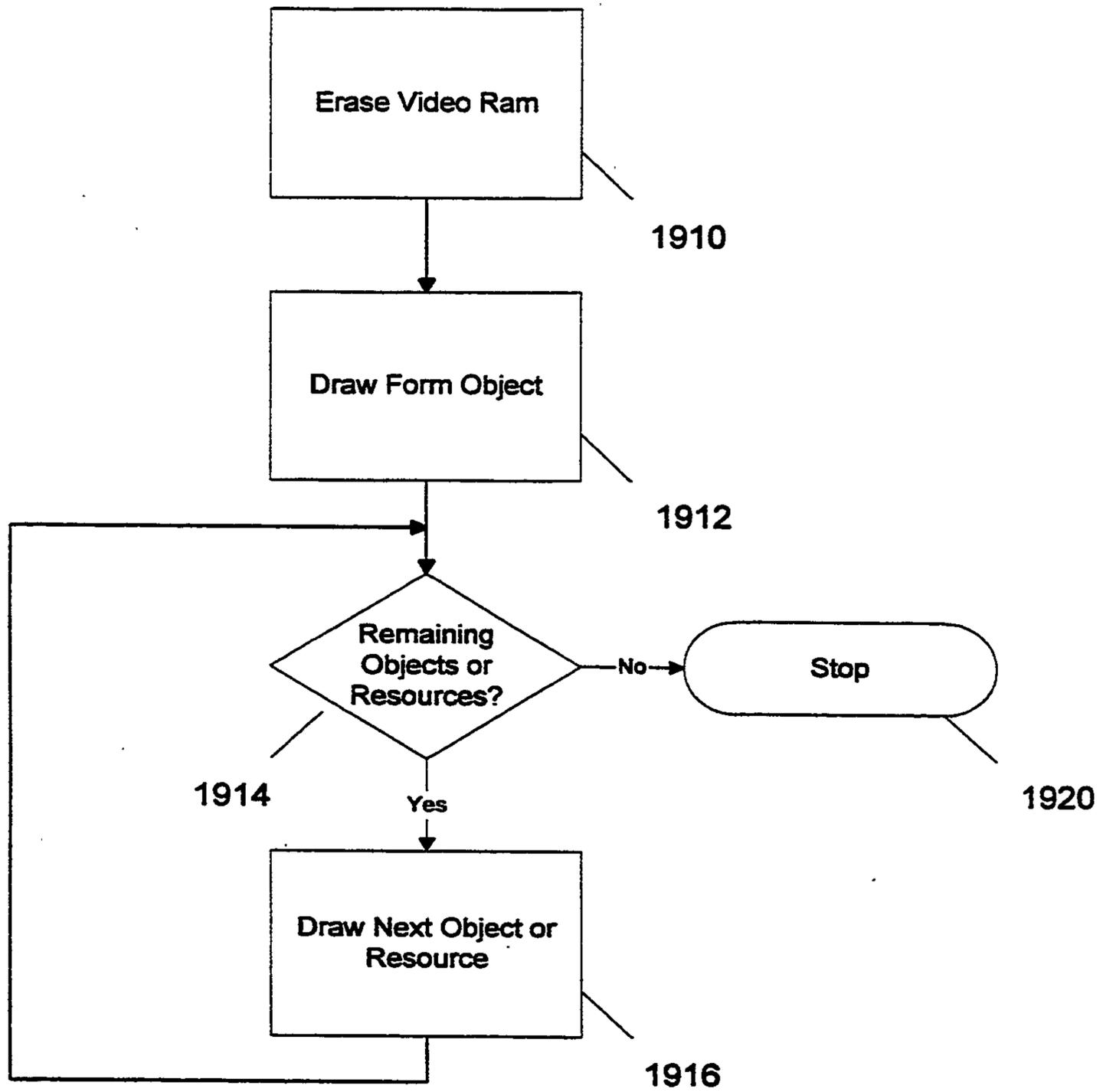

Fig. 19

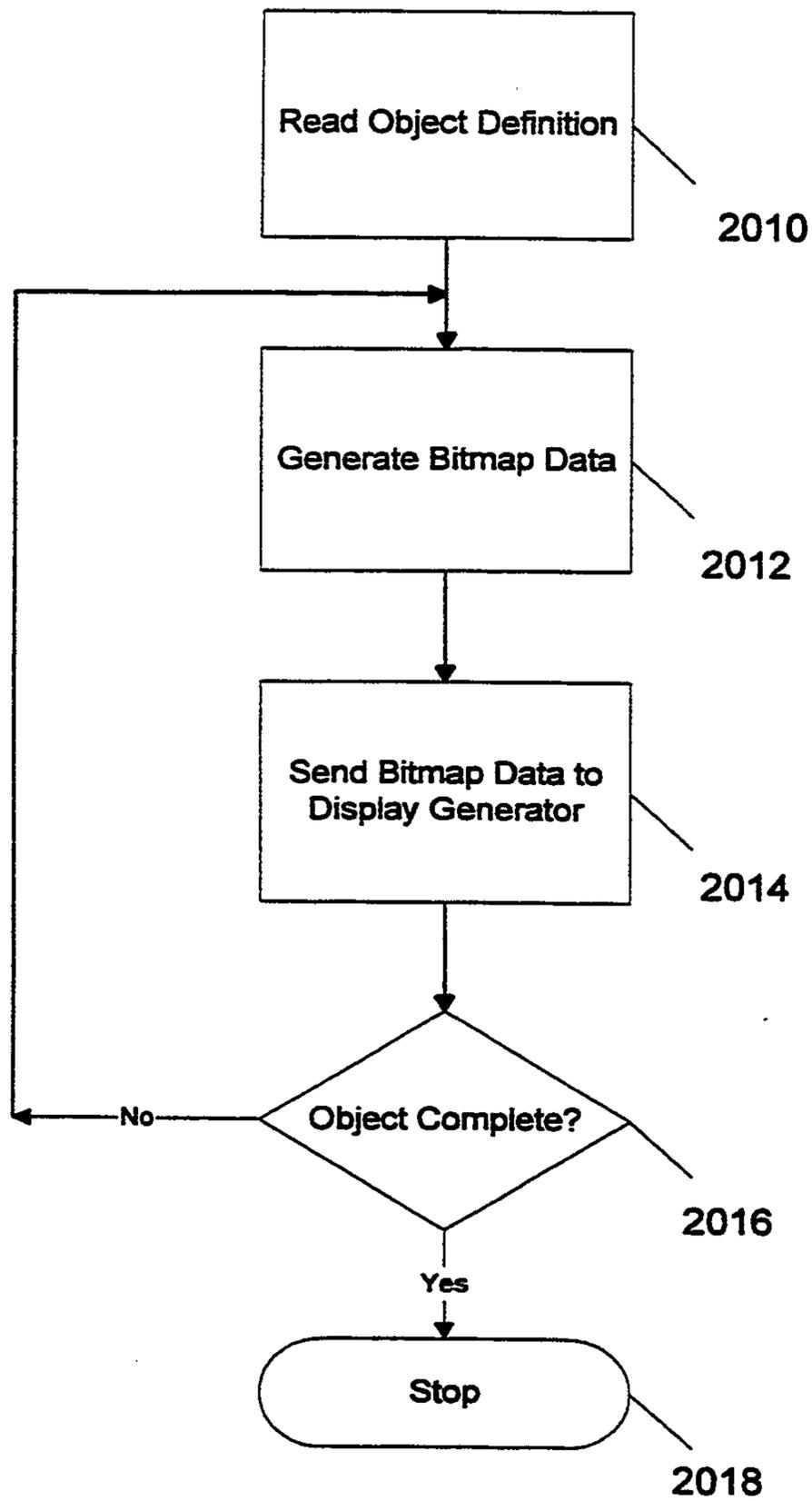

Fig. 20

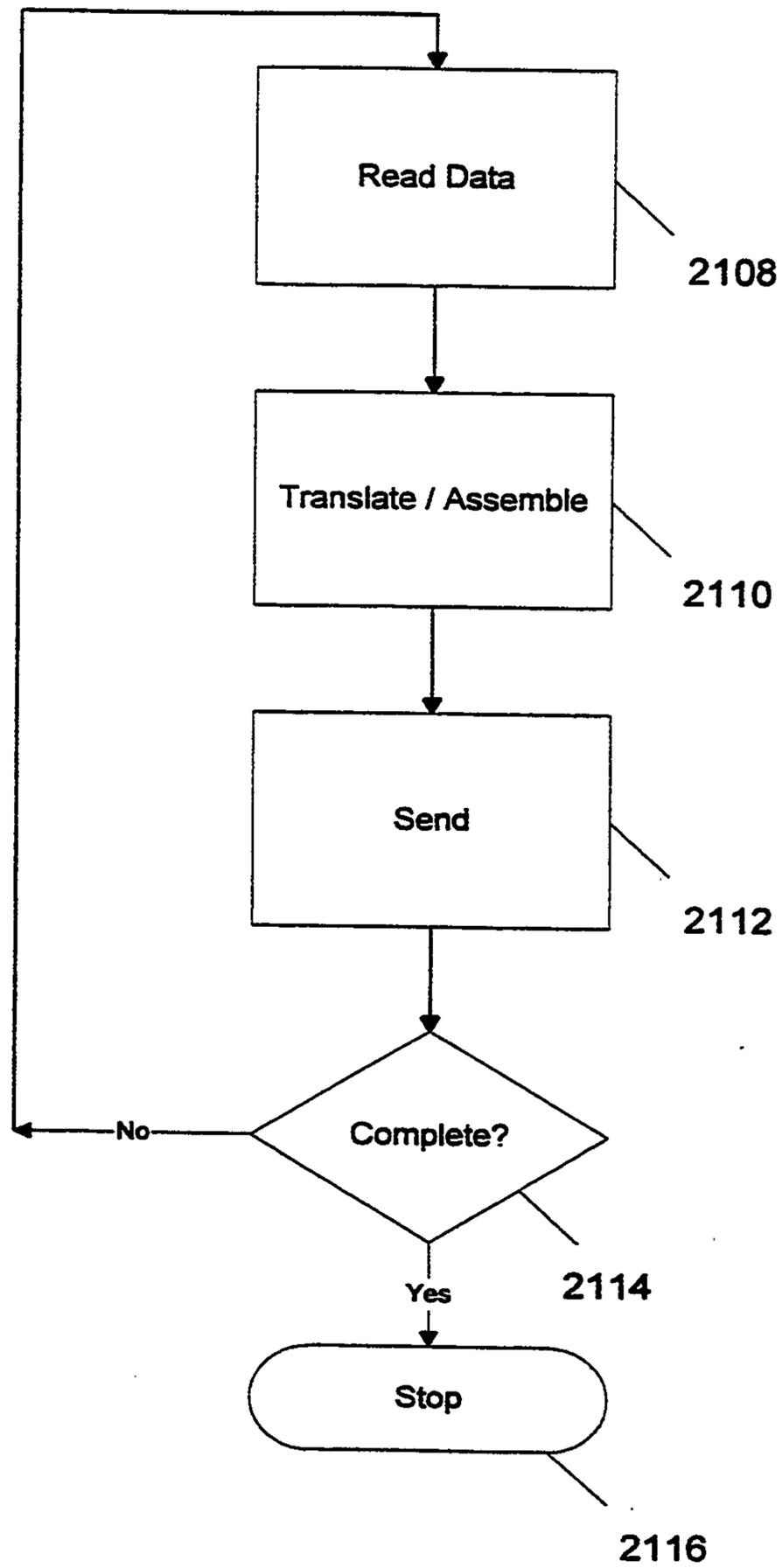
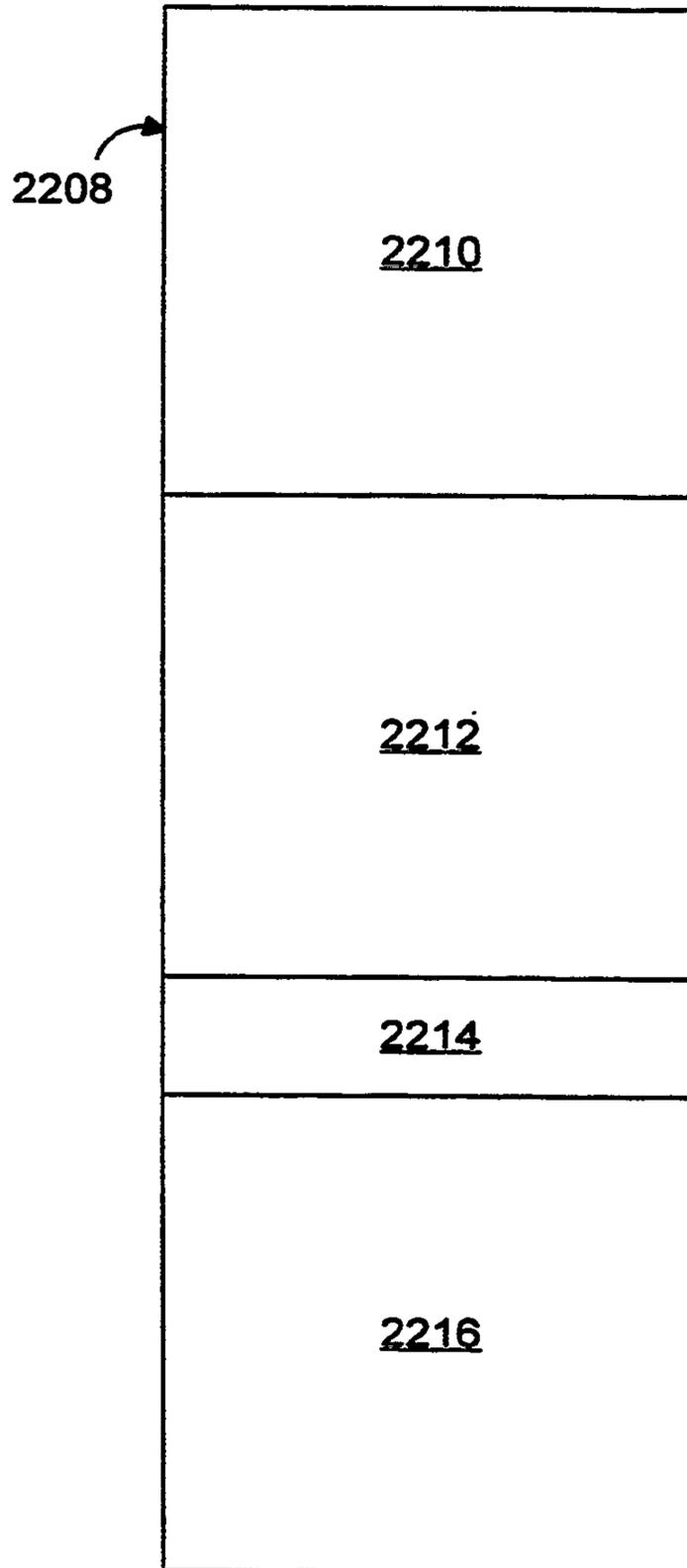

Fig. 21



*Fig. 22*

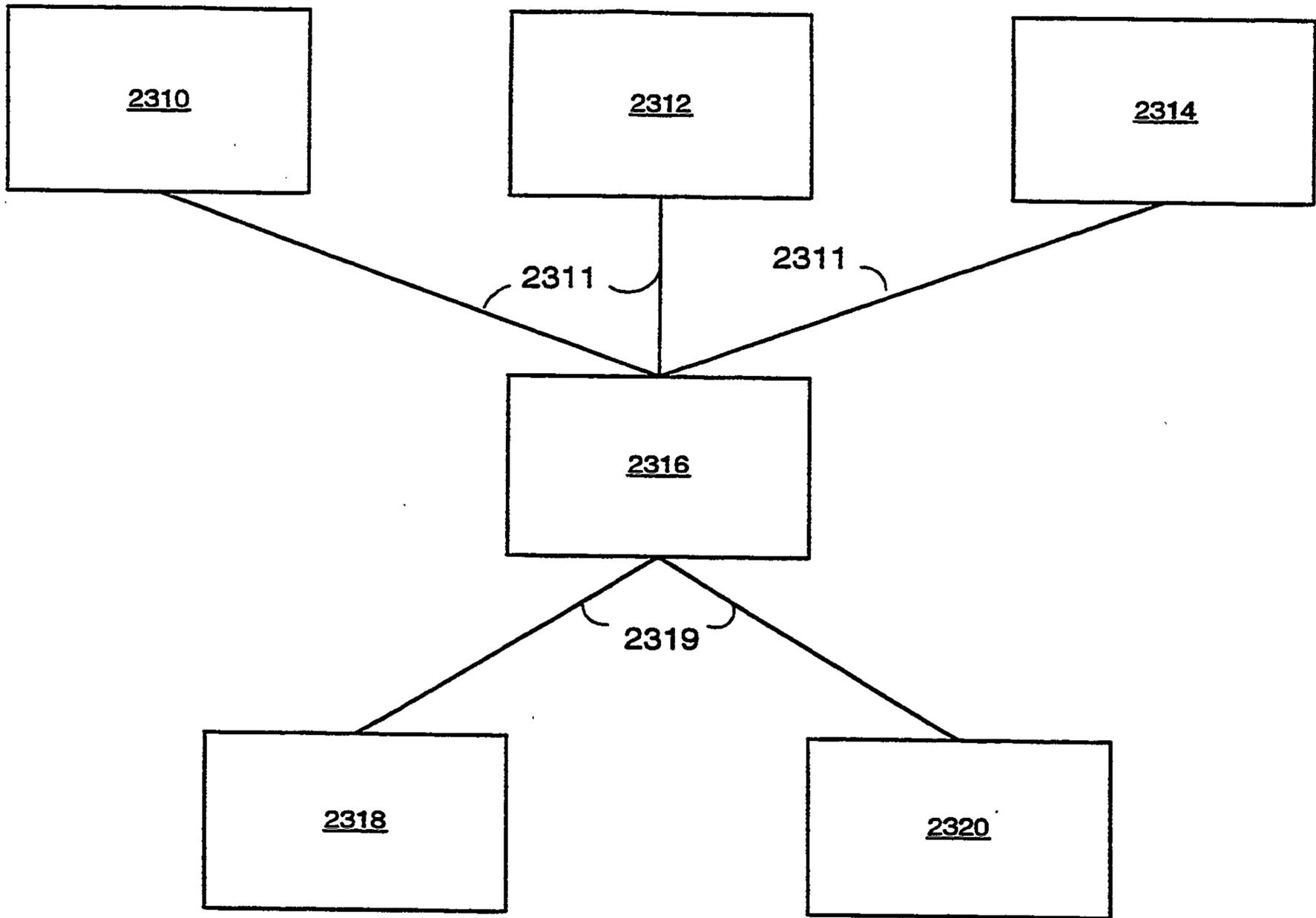
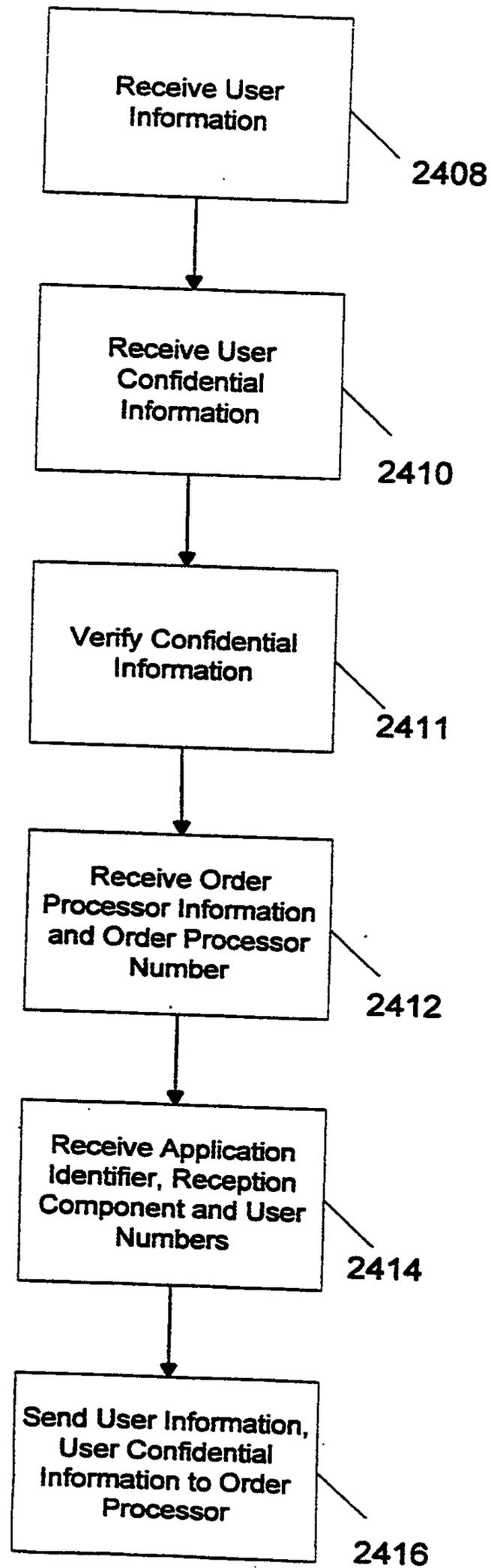
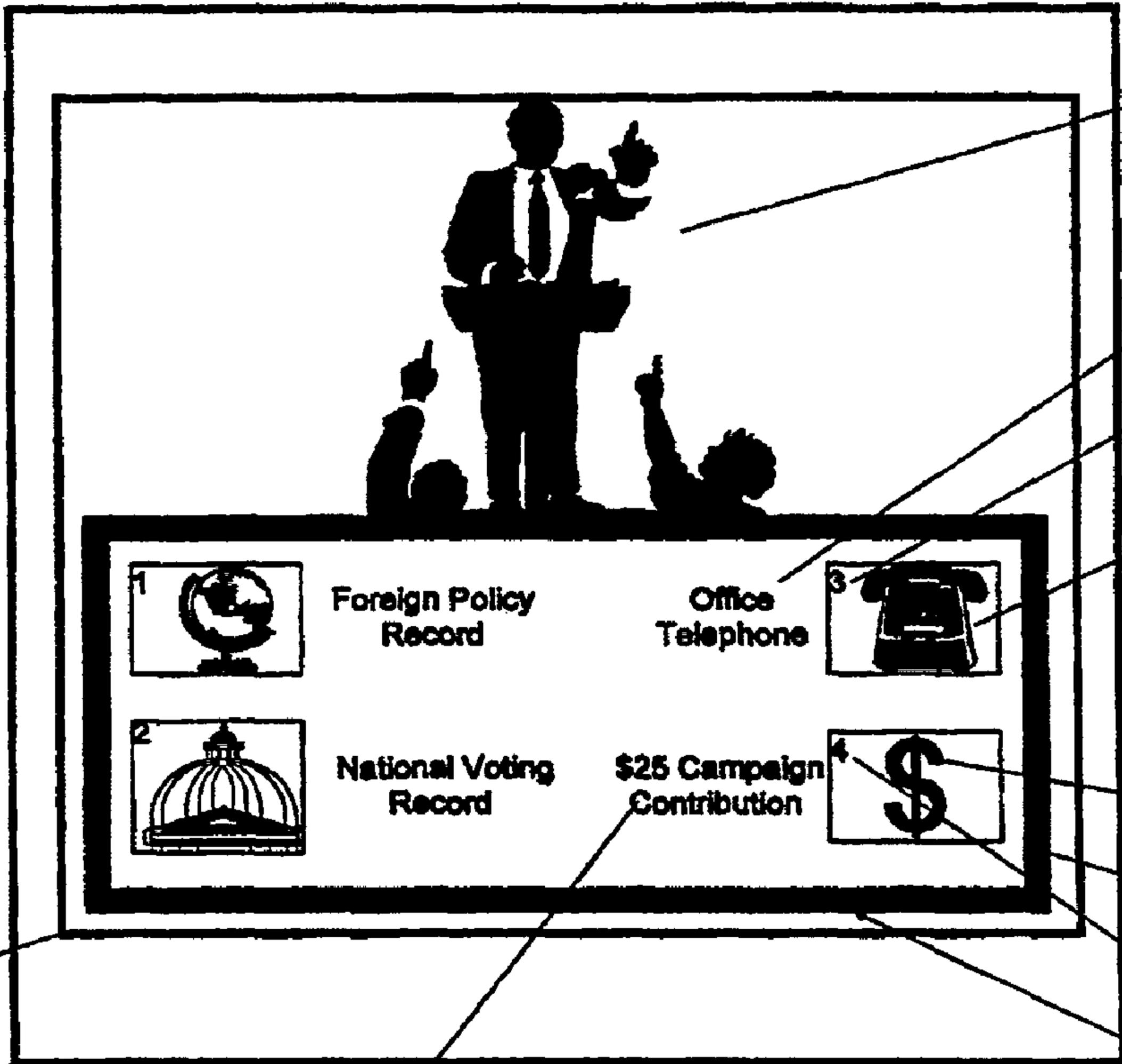

Fig. 23



*Fig. 24*



114

128

124

122

120

130

118

116

110

112

126



Foreign Policy Record



Office Telephone



National Voting Record



\$25 Campaign Contribution