



US0D1007126S

(12) **United States Design Patent**
Bidal

(10) **Patent No.:** **US D1,007,126 S**

(45) **Date of Patent:** **** Dec. 12, 2023**

- (54) **SHOE**
- (71) Applicant: **Acushnet Company**, Fairhaven, MA (US)
- (72) Inventor: **Jean-Marie Bidal**, Bridgewater, MA (US)
- (73) Assignee: **Acushnet Company**, Fairhaven, MA (US)

D595,040	S	*	6/2009	Mochen	D2/906
D603,597	S	*	11/2009	Bacon	D2/969
D654,681	S	*	2/2012	Bacon	D2/906
D661,478	S	*	6/2012	Lane	D2/906
D728,205	S	*	5/2015	Weddle	D2/906
D789,672	S	*	6/2017	Lee	D2/972
D806,374	S	*	1/2018	Weddle	D2/969
D849,372	S	*	5/2019	Ortega	D2/902
D867,729	S	*	11/2019	Dean	D2/902
D893,849	S	*	8/2020	Bidal	D2/969

(Continued)

(**) Term: **15 Years**

(21) Appl. No.: **29/775,773**

(22) Filed: **Mar. 25, 2021**

(51) **LOC (14) Cl.** **01-02**

(52) **U.S. Cl.**
USPC **D2/969**

(58) **Field of Classification Search**
 USPC D2/896, 900, 902, 904, 906-908,
 D2/916-924, 925-945, 969-979
 CPC A43B 1/00; A43B 1/02; A43B 1/04; A43B
 3/00; A43B 3/02; A43B 3/06; A43B 3/10;
 A43B 3/12; A43B 3/14; A43B 5/00;
 A43B 5/001; A43B 5/002; A43B 5/008;
 A43B 5/06; A43B 5/10; A43B 5/12;
 A43B 23/00; A43B 23/02; A43B 23/04
 See application file for complete search history.

(56) **References Cited**

U.S. PATENT DOCUMENTS

D276,569	S	*	12/1984	Kohno	D2/908
D522,722	S	*	6/2006	Wilkenfeld	D2/902
D539,519	S	*	4/2007	Mochen	D2/969
D544,699	S	*	6/2007	Link	D2/972
D560,340	S	*	1/2008	Lane, III	D2/969
D565,283	S	*	4/2008	Smith	D2/907
D571,992	S	*	7/2008	Robinson, Jr.	D2/969
D576,381	S	*	9/2008	Weber	D2/960

OTHER PUBLICATIONS

Fuel, Footjoy.com, [online], [site visited Nov. 22, 2022]. <URL: https://www.footjoy.com/men/golf-shoes/spikeless/fuel/000FJF.html?dwvar_000FJF_color=55451> (Year: 2022).*

(Continued)

Primary Examiner — Jonathan J Han
(74) *Attorney, Agent, or Firm* — Kristin D. Wheeler

(57) **CLAIM**

The ornamental design for a shoe, as shown and described.

DESCRIPTION

FIG. 1 is a top perspective view of a shoe showing my new design;
 FIG. 2 is a top plan view of the shoe of a shoe, thereof;
 FIG. 3 is a lateral side elevation view of the shoe, thereof;
 FIG. 4 is a medial side elevation view of the shoe, thereof;
 FIG. 5 is a rear elevation view of the shoe, thereof;
 FIG. 6 is a front elevation view of the shoe, thereof; and,
 FIG. 7 is a bottom plan view of the shoe thereof.
 In FIGS. 1-7, the broken lines on the upper of the shoe, including any laces, eyelets, tongue or logos, form no part of the claimed design. Also, the broken lines showing a shoe outsole, including any logos, form no part of the claimed design.

1 Claim, 6 Drawing Sheets

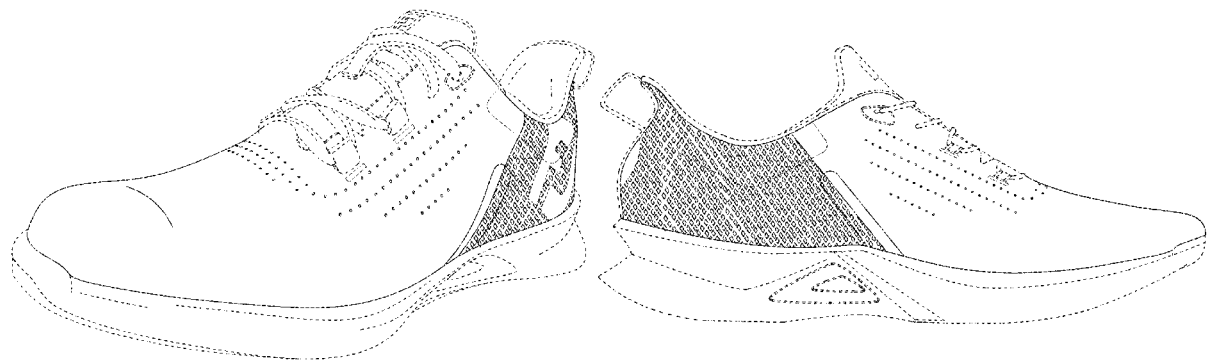

(56)

References Cited

U.S. PATENT DOCUMENTS

D894,542	S	*	9/2020	Bidal	D2/906
D907,910	S	*	1/2021	Weddle	D2/969
D912,963	S	*	3/2021	Bidal	D2/969
D913,650	S	*	3/2021	Ortega	D2/908
D913,672	S	*	3/2021	Bidal	D2/969
D913,673	S	*	3/2021	Weddle	D2/969
D913,674	S	*	3/2021	Suh	D2/969
D929,110	S	*	8/2021	DeAlmeida	D2/972
D929,707	S	*	9/2021	Suh	D2/951
D933,348	S	*	10/2021	Bidal	D2/969
D938,711	S	*	12/2021	Ortega	D2/969
D943,912	S	*	2/2022	Bidal	D2/969

OTHER PUBLICATIONS

FJ Fuel BOA, Footjoy.com, [online], [site visited Nov. 22, 2022].
<URL: https://www.footjoy.com/men/golf-shoes/spikeless/fj-fuel-boa/001FJF.html?dwvar_001FJF_color=55446> (Year: 2022).*

Footjoy Men's FJ Fuel Boa Golf Shoe, Amazon.com, Date First Available: Sep. 27, 2022, [online], [site visited Nov. 22, 2022].
<URL: <https://www.amazon.com/dp/B09GL39RVM?tag=runrepcom-gf-20&linkCode=ogi&th=1&psc=1>> (Year: 2022).*

* cited by examiner

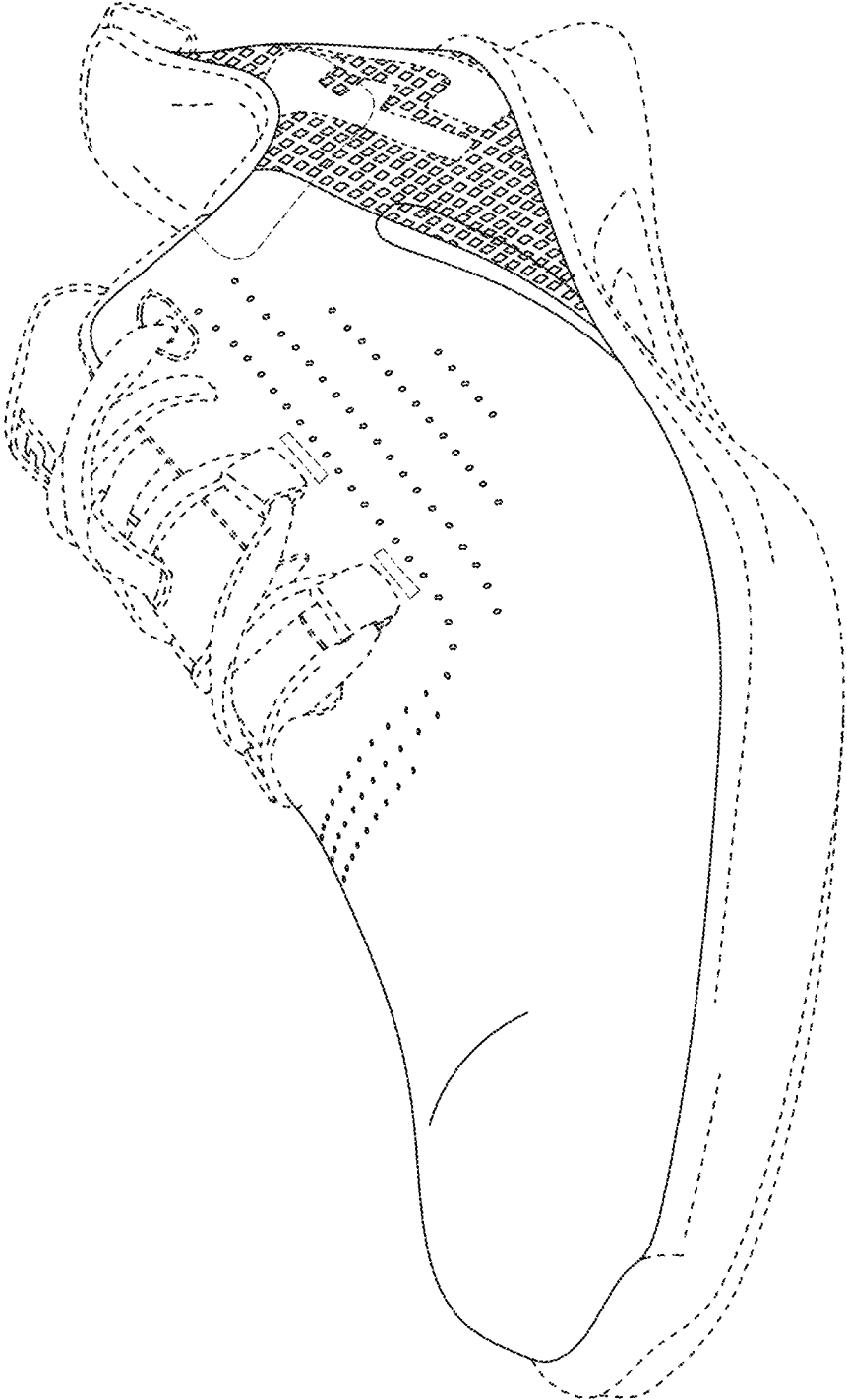

FIG. 1

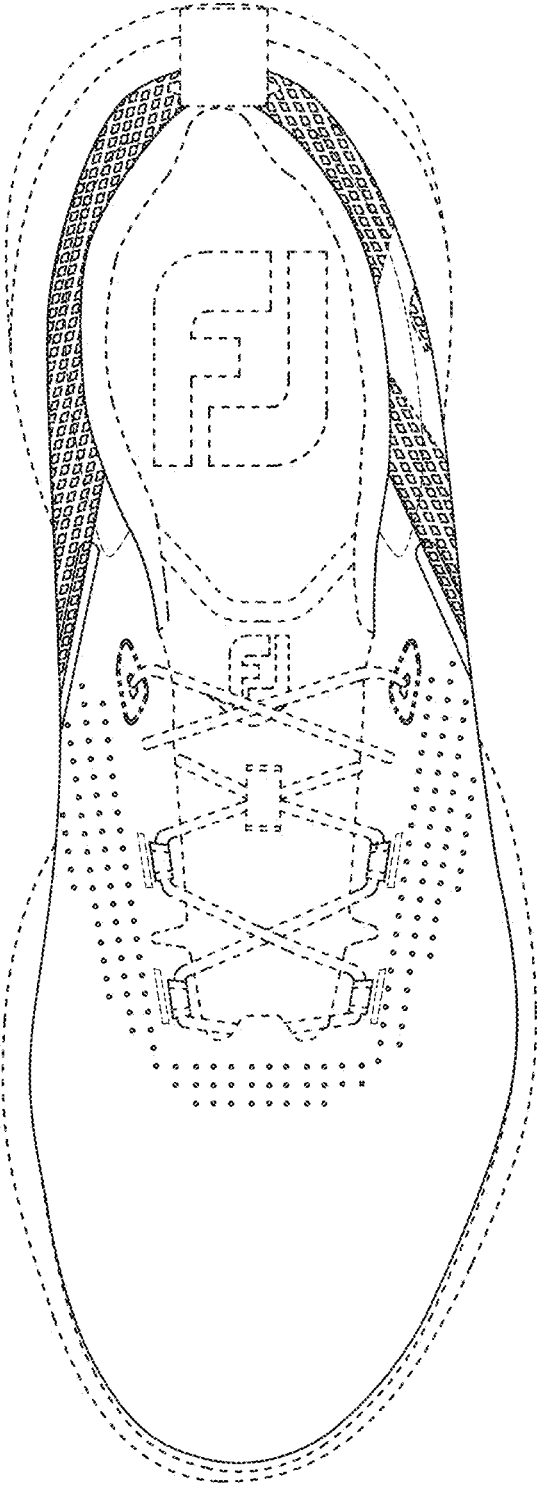

FIG. 2

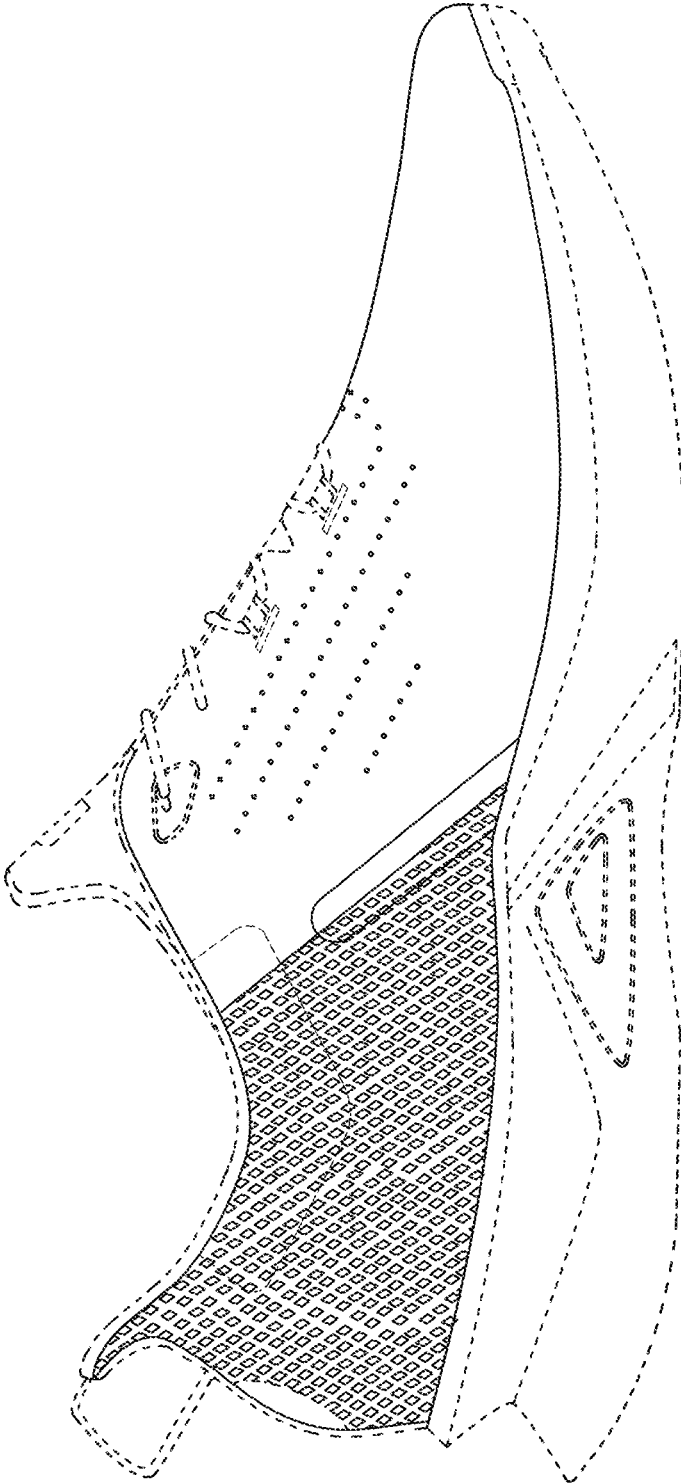

FIG. 3

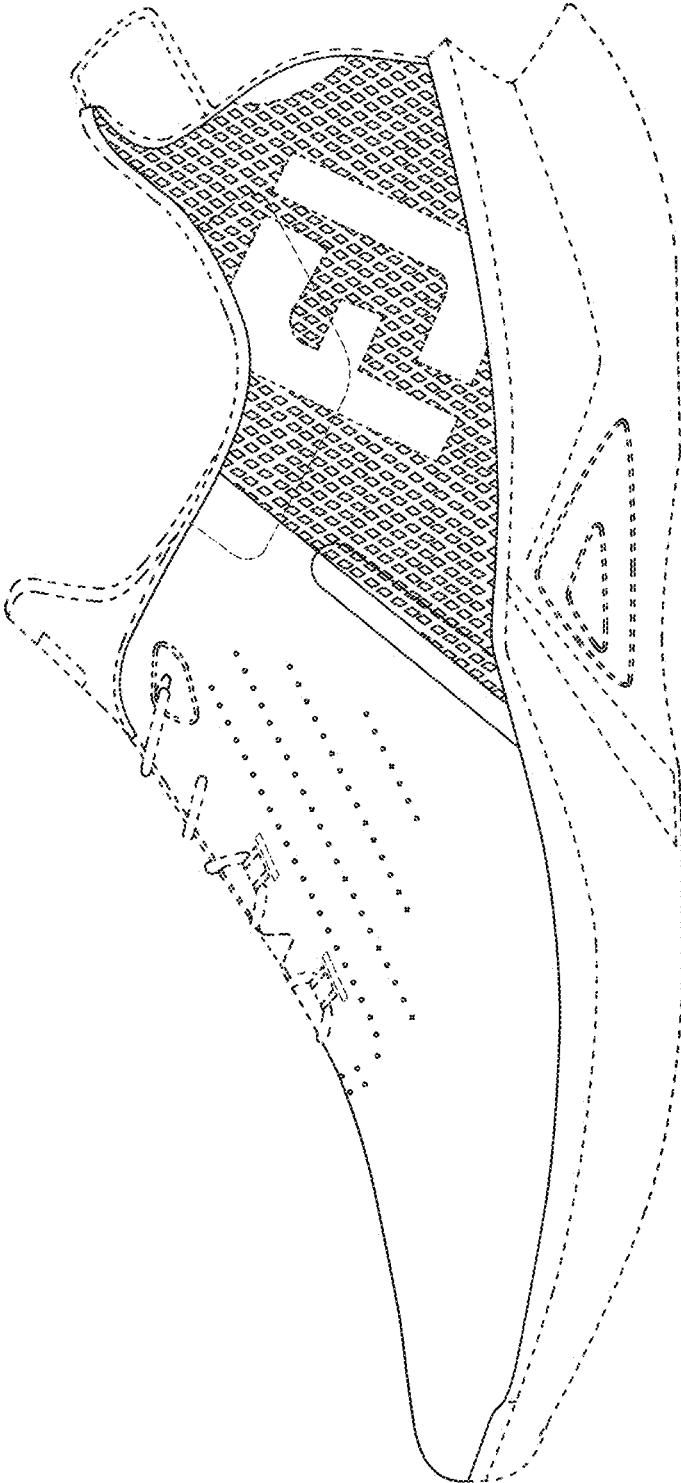

FIG. 4

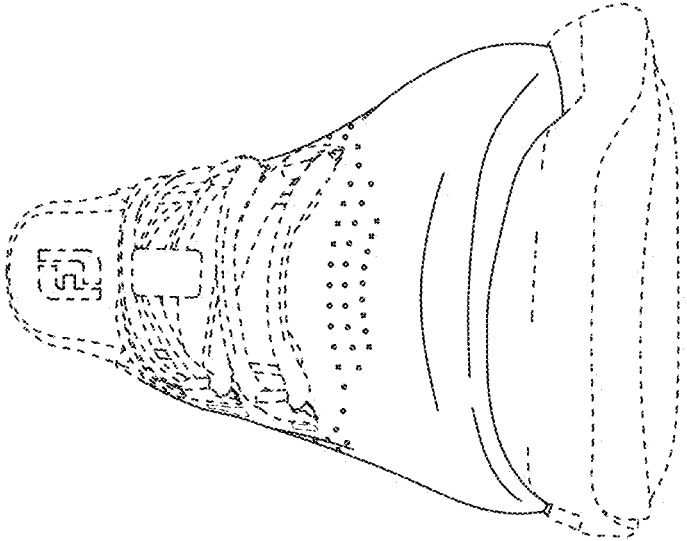

FIG. 5

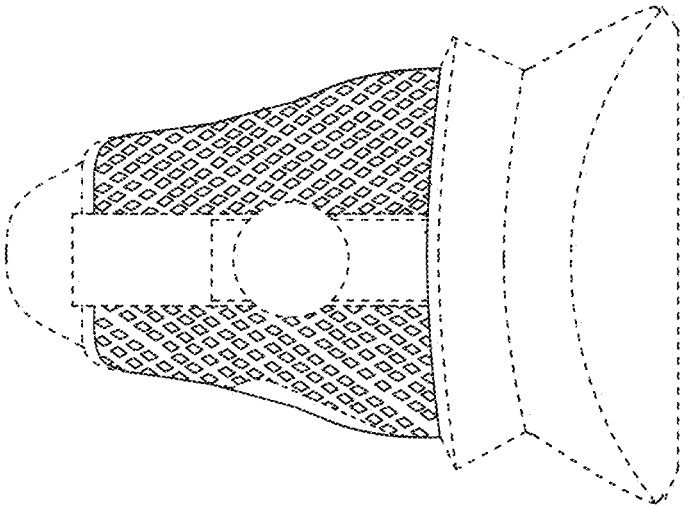

FIG. 6

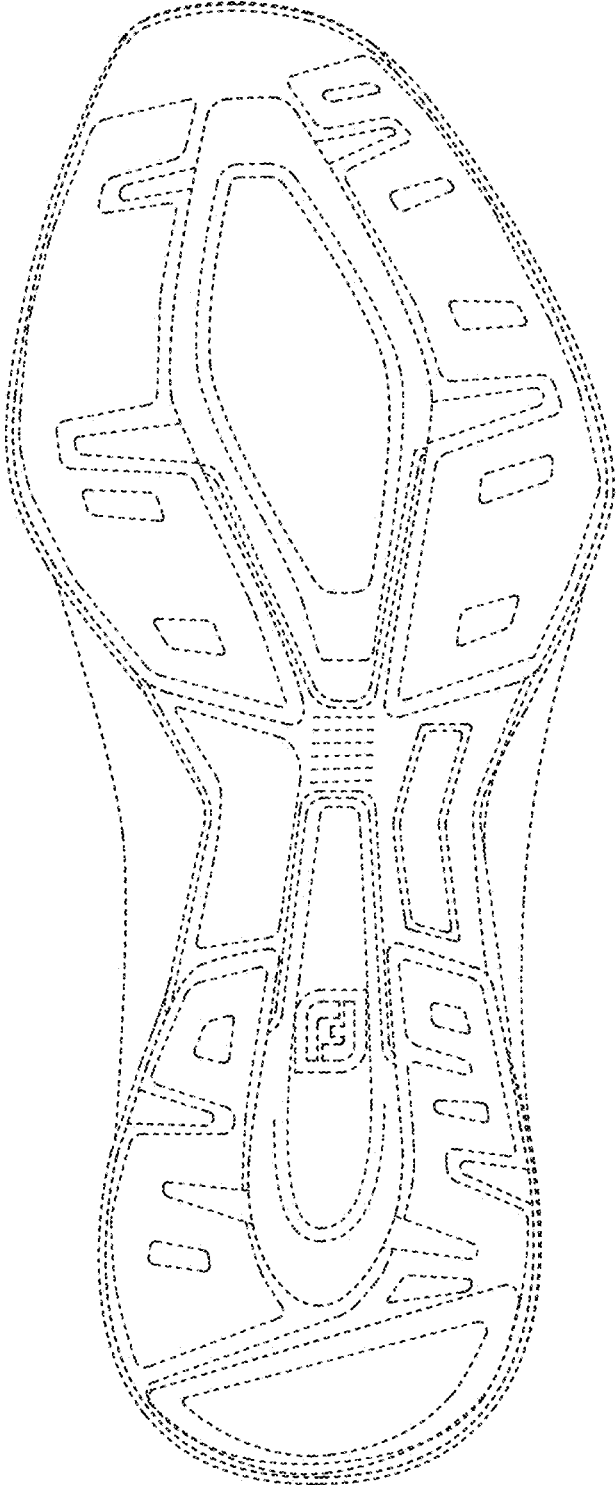

FIG. 7