



US0D1069148S

(12) **United States Design Patent**  
**Wu**

(10) **Patent No.:** **US D1,069,148 S**

(45) **Date of Patent:** **\*\* Apr. 1, 2025**

(54) **NECK MASSAGER WITH BASE**

(71) Applicant: **Zemin Wu**, Chibi (CN)

(72) Inventor: **Zemin Wu**, Chibi (CN)

(\*\*) Term: **15 Years**

(21) Appl. No.: **29/908,295**

(22) Filed: **Jan. 11, 2024**

(30) **Foreign Application Priority Data**

Jan. 10, 2024 (EM) ..... 015046908-0001

(51) **LOC (15) Cl.** ..... **24-01**

(52) **U.S. Cl.**

USPC ..... **D24/215**

(58) **Field of Classification Search**

USPC ..... D24/215, 200, 211, 212, 213, 214, 133,  
D24/107, 231, 141; D28/4, 7, 9, 99, 12,  
D28/13

CPC ..... A61H 7/00; A61H 7/002; A61H 7/003;  
A61H 7/004; A61H 7/005; A61H  
2205/022; A61H 5/00; A61B 2017/00747;  
A61N 5/06; A61N 5/0616

See application file for complete search history.

(56) **References Cited**

**U.S. PATENT DOCUMENTS**

D840,546 S \* 2/2019 Xiangmei ..... D24/209  
D855,194 S \* 7/2019 Kymm ..... D24/209  
D858,786 S \* 9/2019 Luo ..... D24/214  
D876,623 S \* 2/2020 Yang ..... D24/133

(Continued)

**FOREIGN PATENT DOCUMENTS**

CN 303598443 \* 2/2016  
CN 306446164 \* 4/2021

(Continued)

**OTHER PUBLICATIONS**

Ihelol Neck Face Massager. Date: Apr. 24, 2024. [online]. [Site visited Aug. 13, 2024]. Available from Internet URL: <https://www.amazon.com/Massager-Multifunctional-Sculpting-Vibration-Thermal/dp/B0D2KBSBY6?th=1> (Year: 2024).\*

(Continued)

*Primary Examiner* — Eliza Z Harvey

*Assistant Examiner* — Landon Thomas Cassell

(74) *Attorney, Agent, or Firm* — Shen Huang

(57) **CLAIM**

The ornamental design for a neck massager with base, as shown and described.

**DESCRIPTION**

FIG. 1 is a first perspective view of a neck massager with base, without the base shown, showing my new design; FIG. 2 is a second perspective view thereof; FIG. 3 is a front view thereof; FIG. 4 is a back view thereof; FIG. 5 is a left side view thereof; FIG. 6 is a right side view thereof; FIG. 7 is a top view thereof; FIG. 8 is a bottom view thereof; FIG. 9 is a first perspective view of the base of a neck massager with base showing my new design; FIG. 10 is a second perspective view thereof; FIG. 11 is a front view thereof; FIG. 12 is a back view thereof; FIG. 13 is a left side view thereof; FIG. 14 is a right side view thereof; FIG. 15 is a top view thereof; FIG. 16 is a bottom view thereof; and, FIG. 17 is a perspective view of the neck massager with base thereof.

The broken lines shown in the drawings depict portions of the neck massager with base that form no part of the claimed design.

**1 Claim, 17 Drawing Sheets**

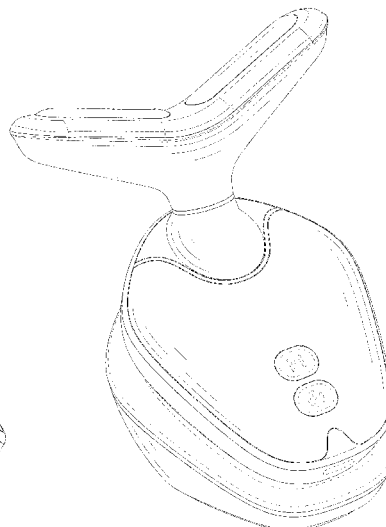
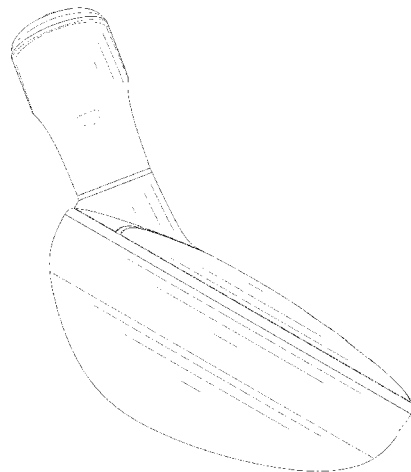

(56)

**References Cited**

U.S. PATENT DOCUMENTS

D935,635 S \* 11/2021 Wang ..... D24/214  
D957,664 S \* 7/2022 Peterson ..... D24/215  
D982,766 S \* 4/2023 Yu ..... D24/214  
D1,003,313 S \* 10/2023 Lin ..... D24/215  
D1,021,127 S \* 4/2024 Xi ..... D24/215  
D1,035,902 S \* 7/2024 Ai ..... D24/215

FOREIGN PATENT DOCUMENTS

CN 307801763 \* 1/2023  
CN 308492400 \* 2/2024  
CN 308523530 \* 3/2024  
CN 308692529 \* 6/2024

OTHER PUBLICATIONS

GLO24K Red Light Beauty Device for Face and Neck. Date: May 5, 2021. [online]. [Site visited Aug. 13, 2024]. Available from Internet URL: <https://www.amazon.com/GLO24K-Rejuvenation-Vibration-Technologies-Appearance/dp/B0947W9C43/> (Year: 2021).\*

Masike Neck Face Beauty Device. Date: May 20, 2024. [online]. [Site visited Aug. 13, 2024]. Available from Internet URL: <https://www.amazon.com/dp/B0D4MBS4V8/> (Year: 2024).\*

Tangula—Electric Face Massager. Date: Apr. 15, 2024. [online]. [Site visited Aug. 13, 2024]. Available from Internet URL: <https://www.amazon.co.uk/dp/B0D7W4FLV3/> (Year: 2024).\*

\* cited by examiner

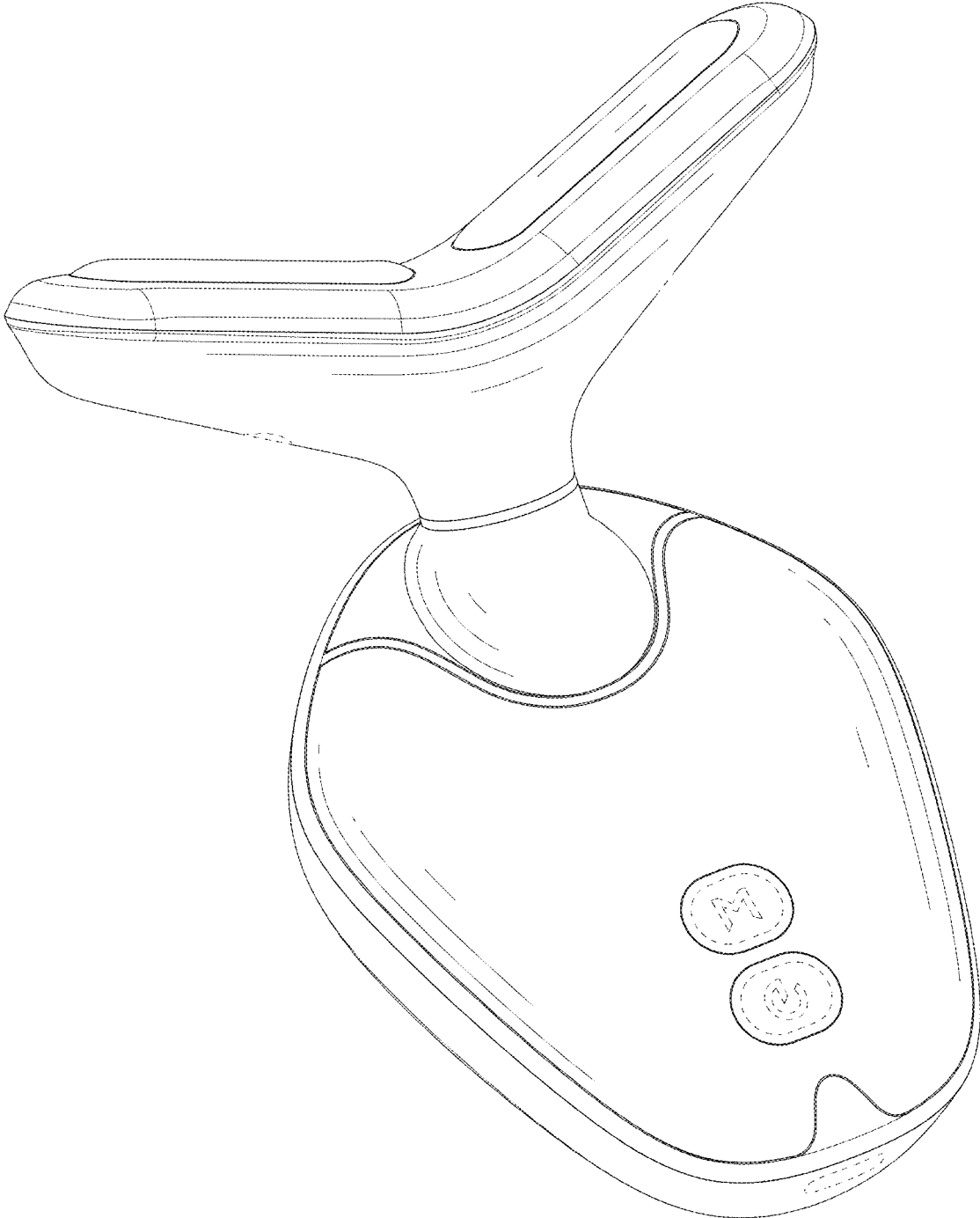

FIG. 1

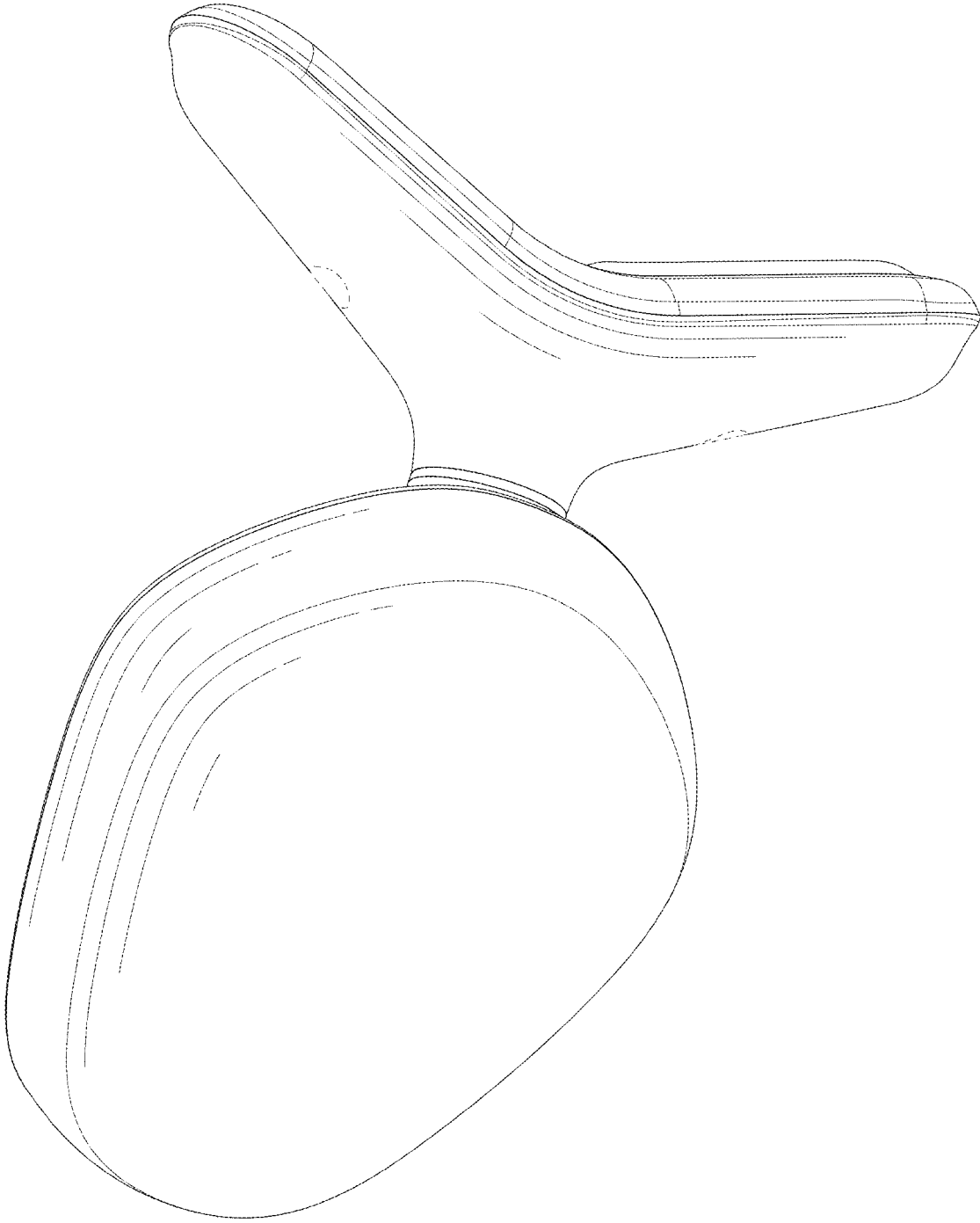

FIG. 2

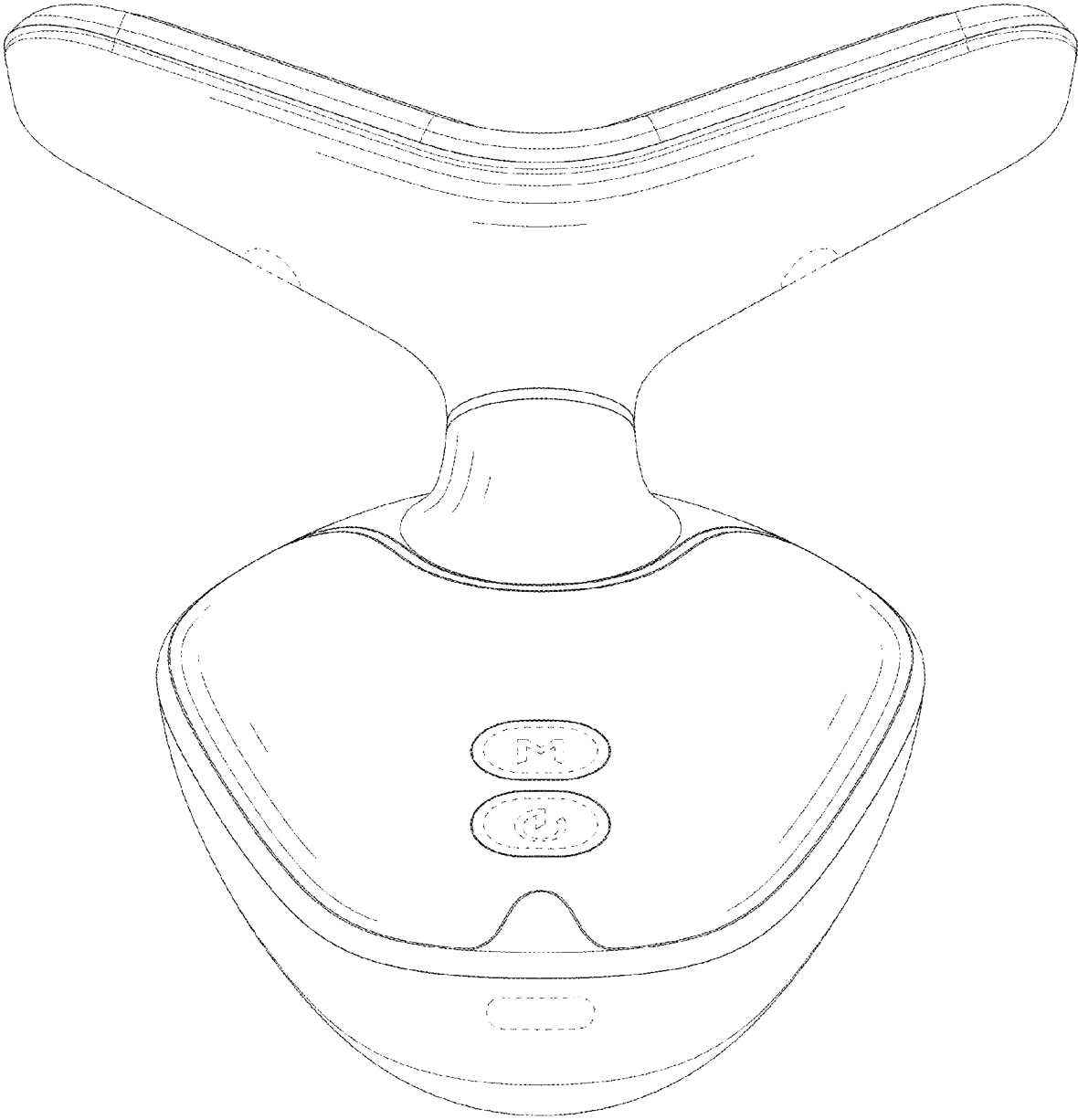

FIG. 3

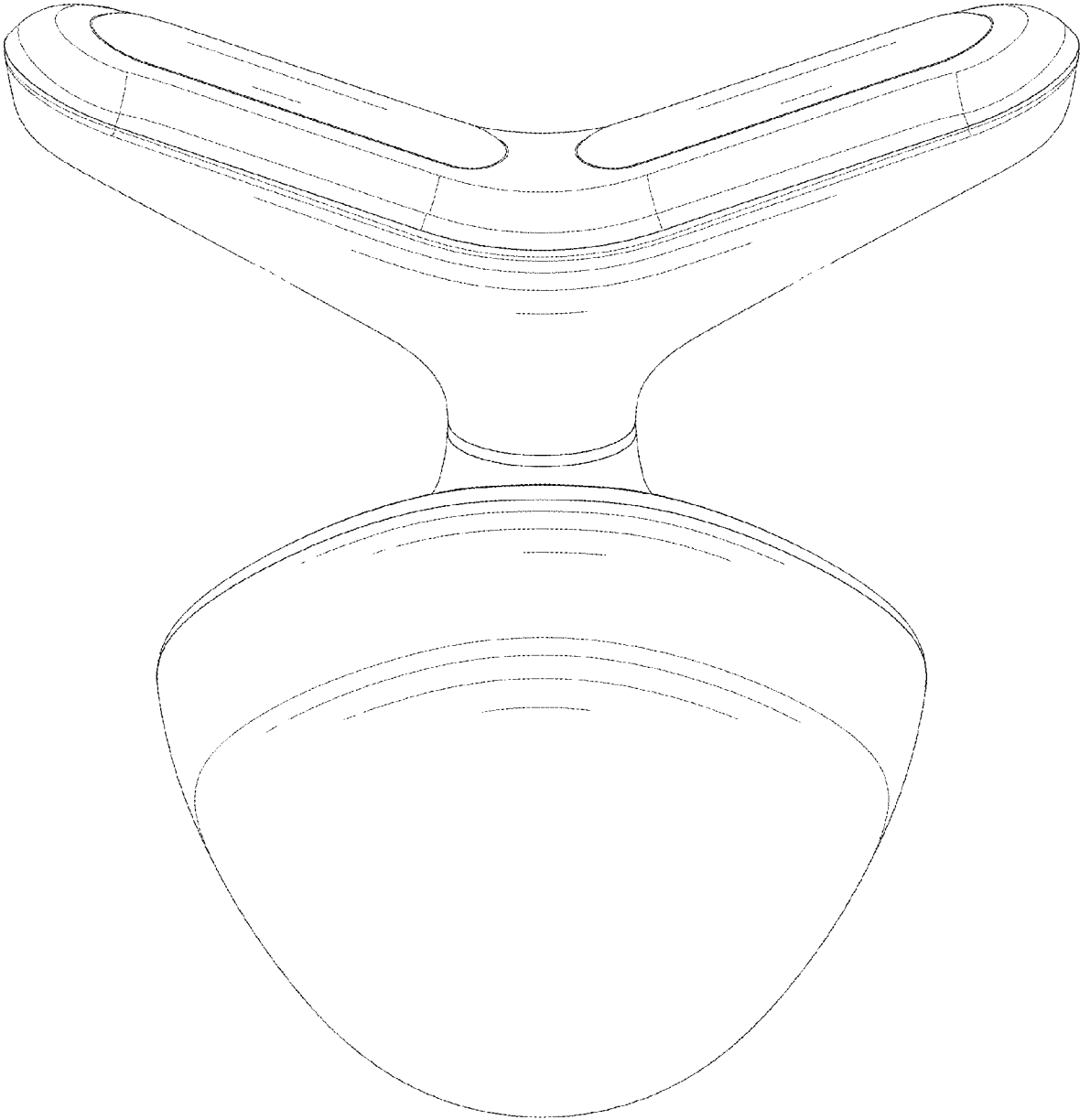

FIG. 4

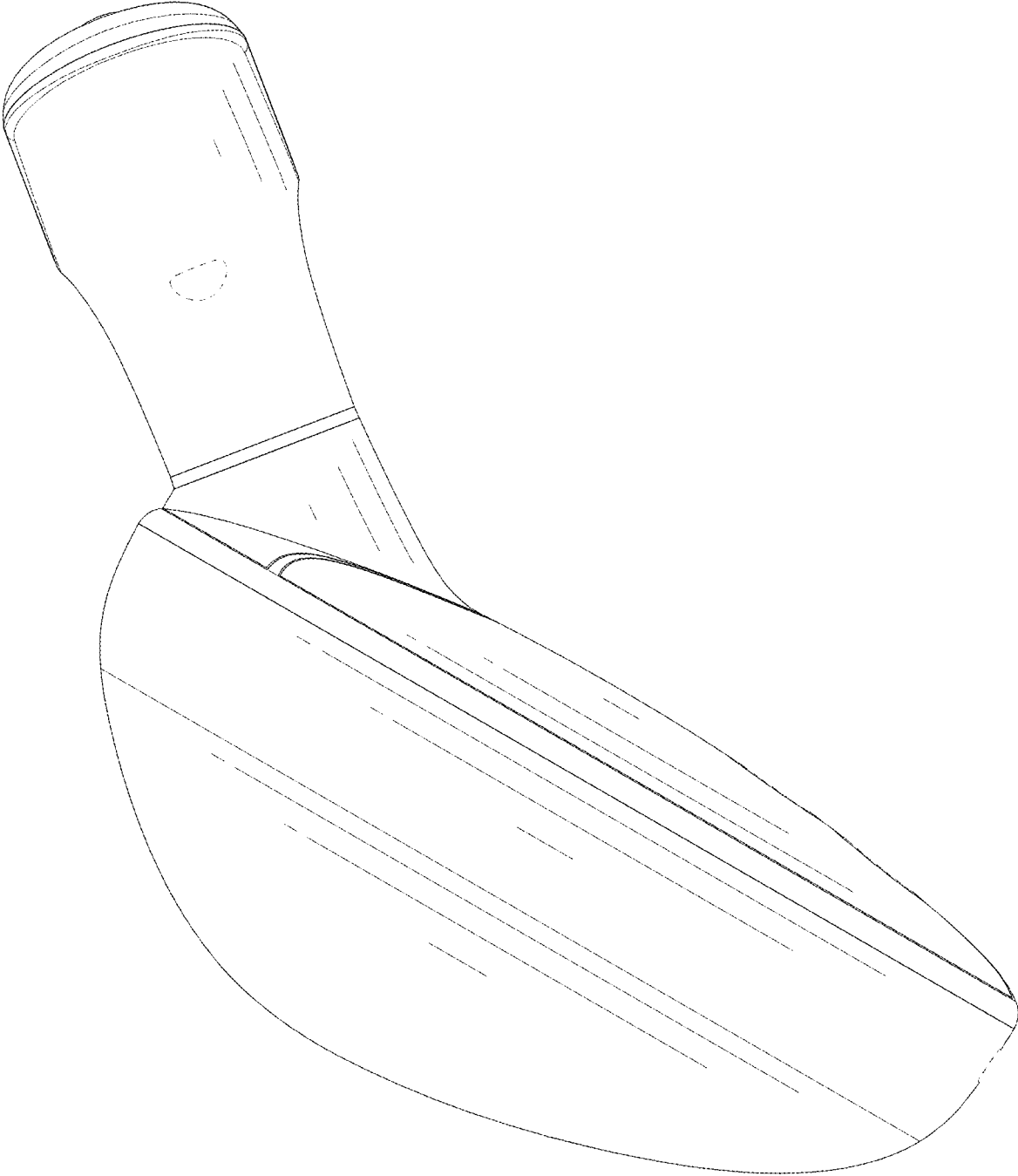

FIG. 5

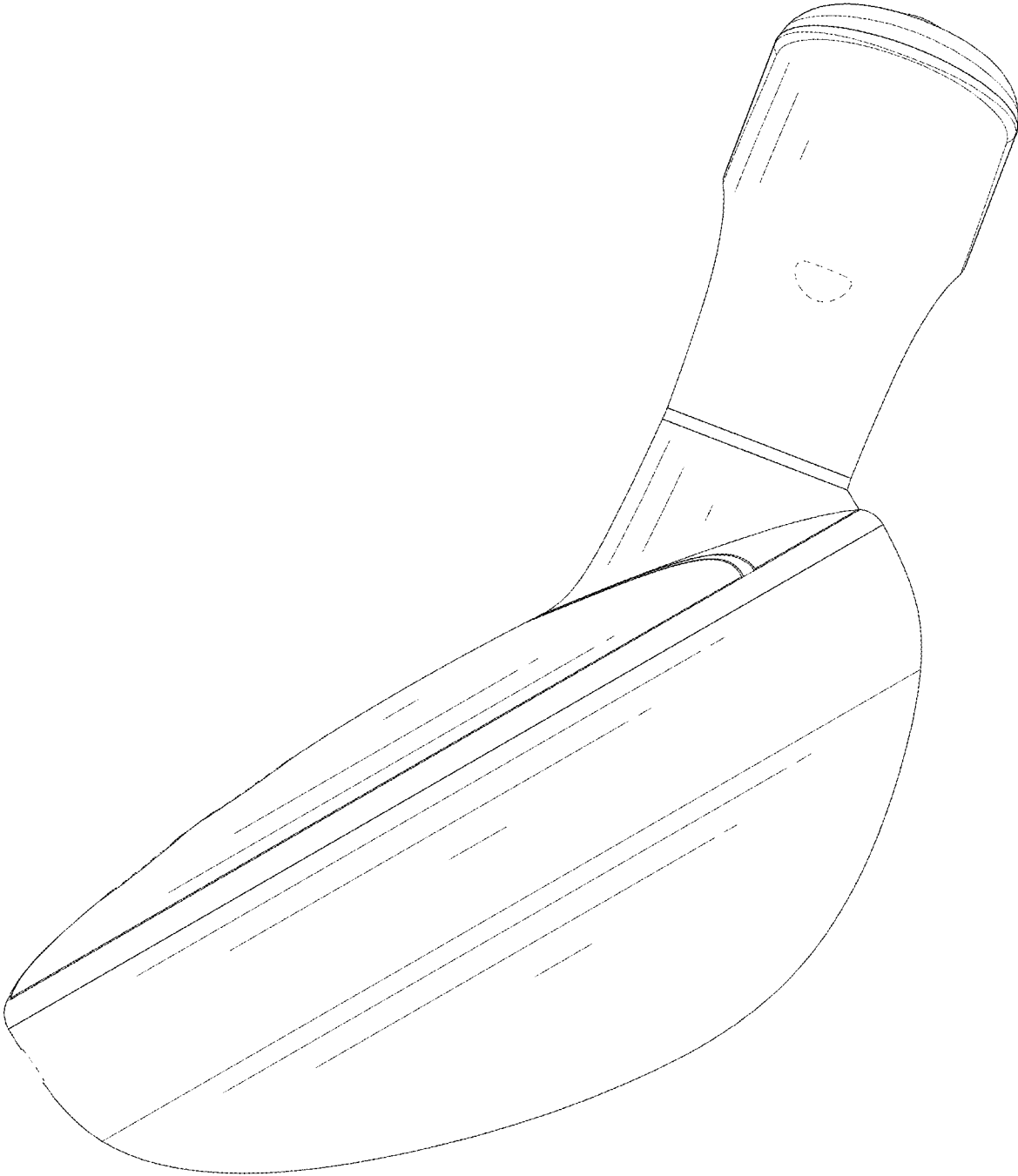

FIG. 6

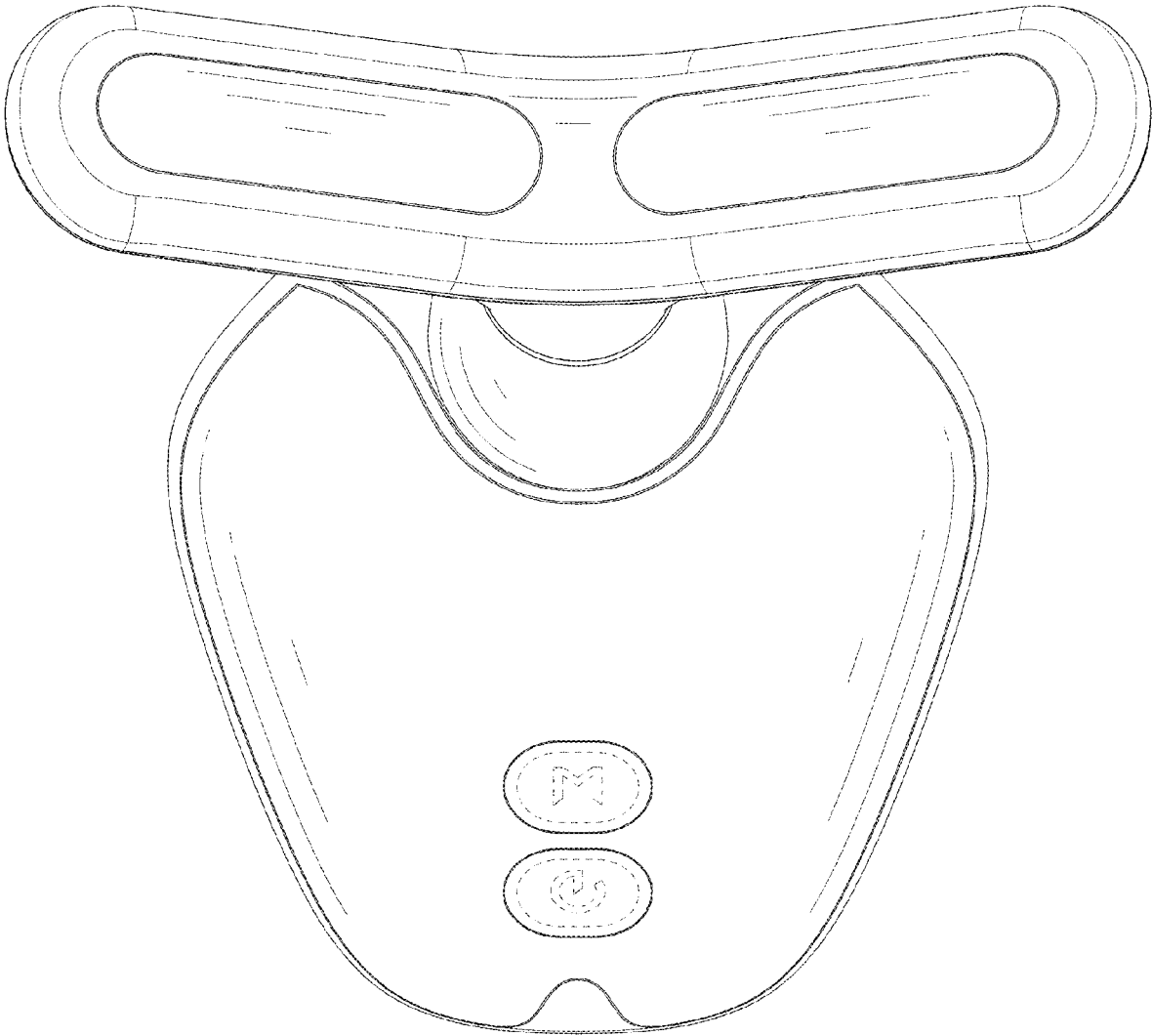

FIG. 7

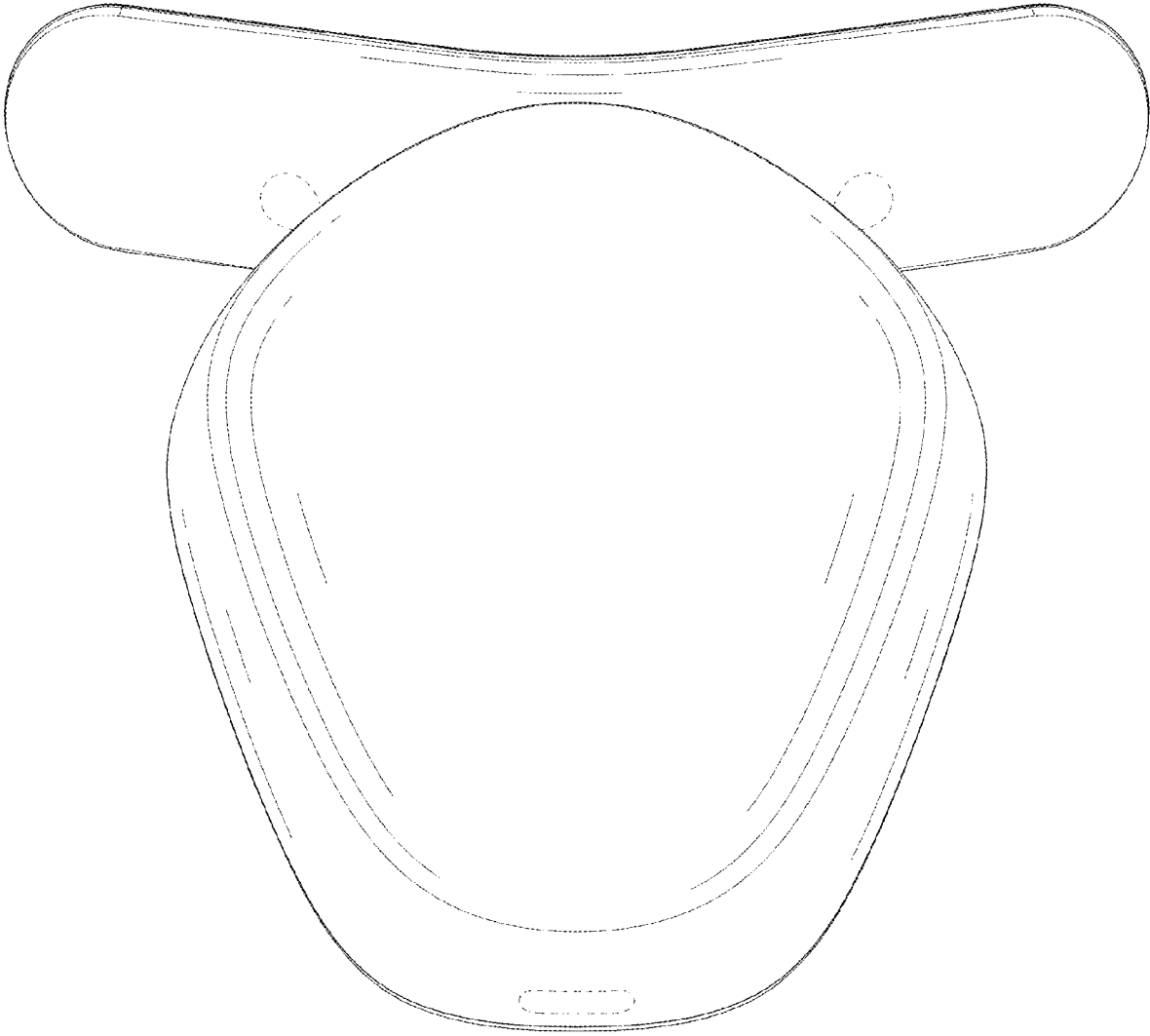

FIG. 8

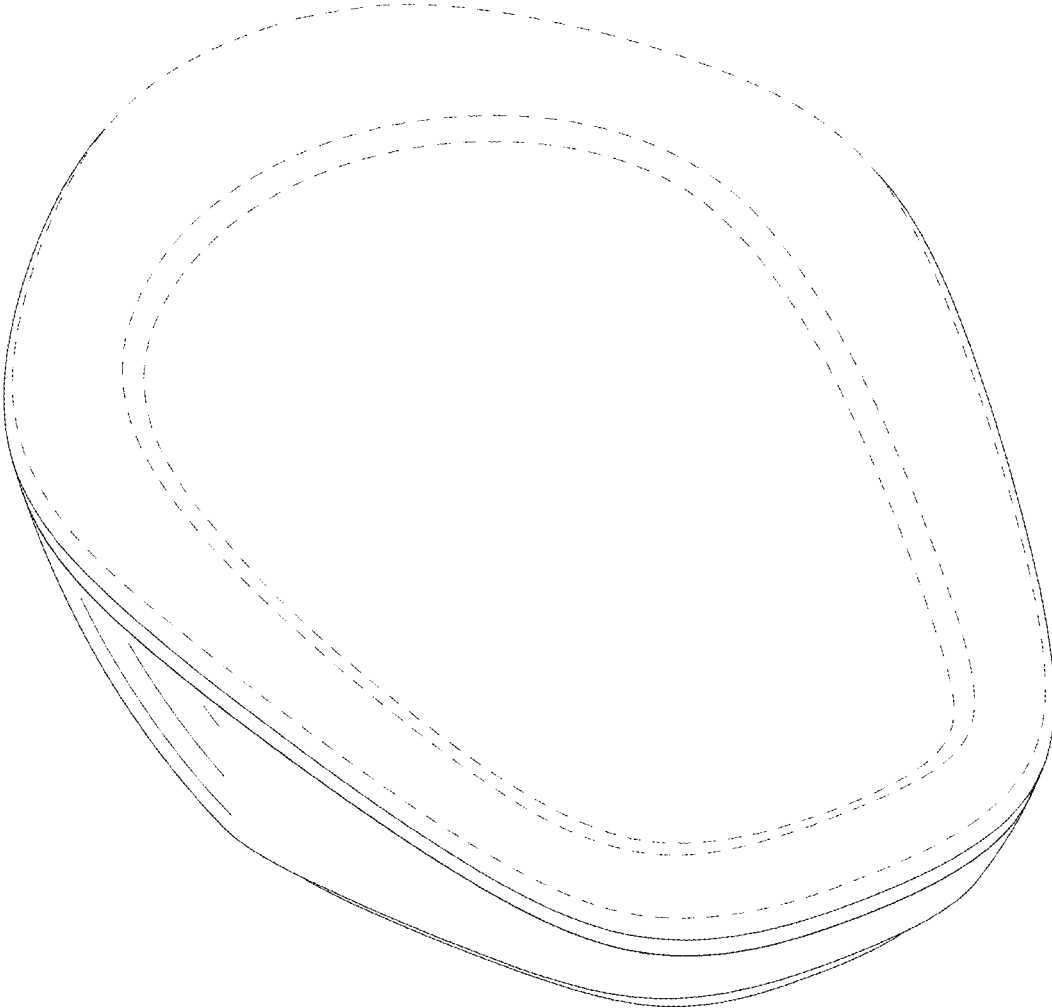

FIG. 9

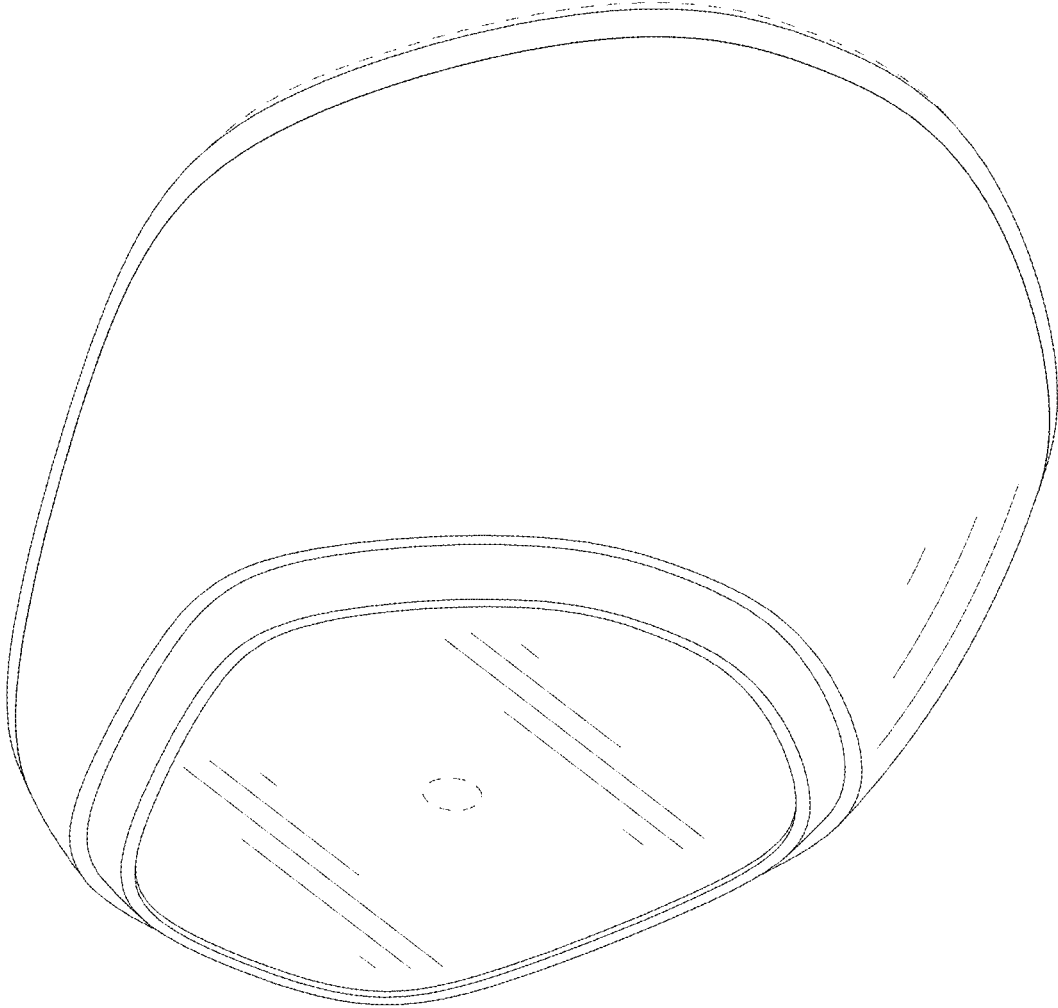

FIG. 10

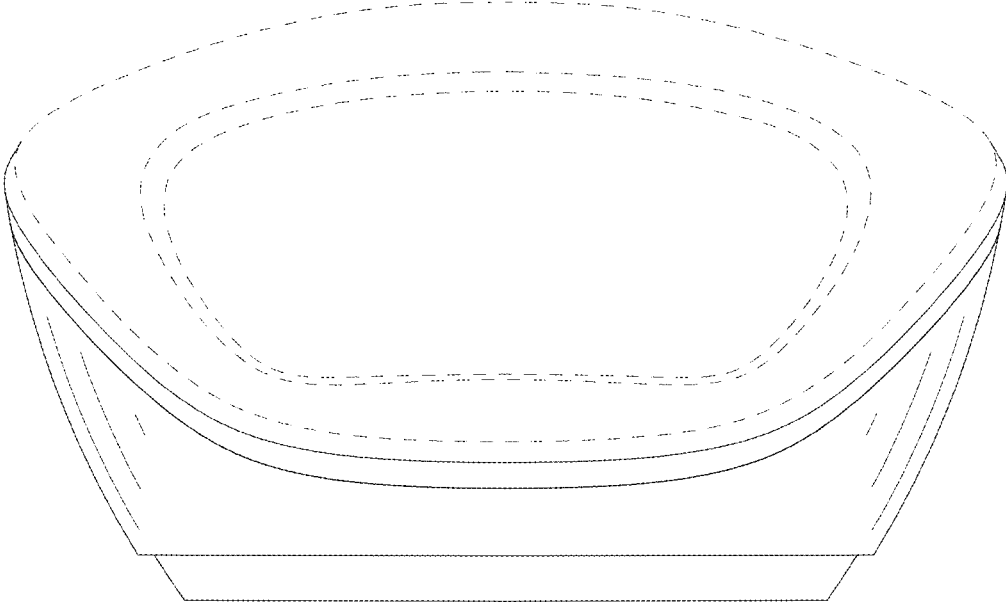

FIG. 11

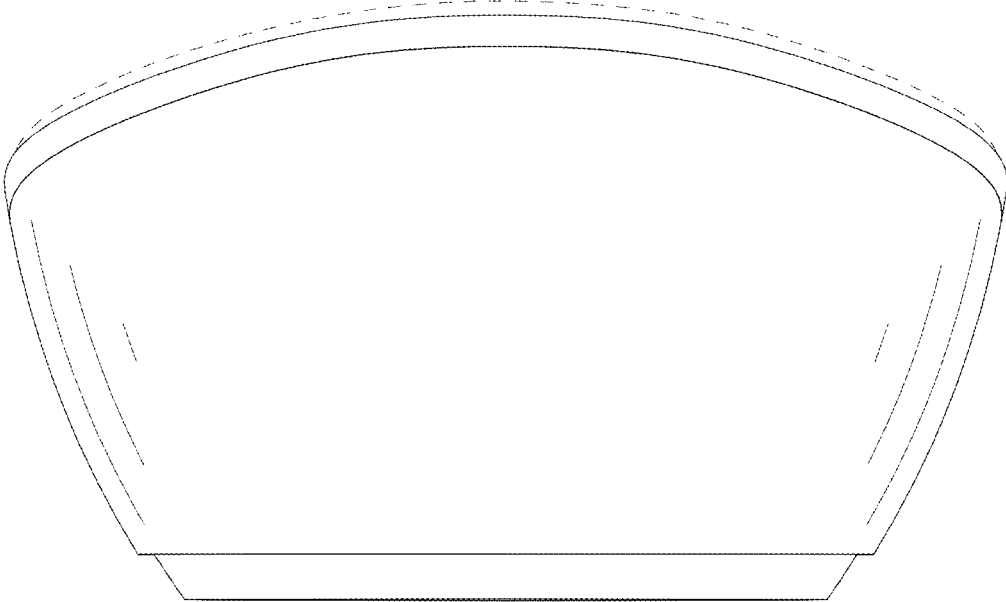

FIG. 12

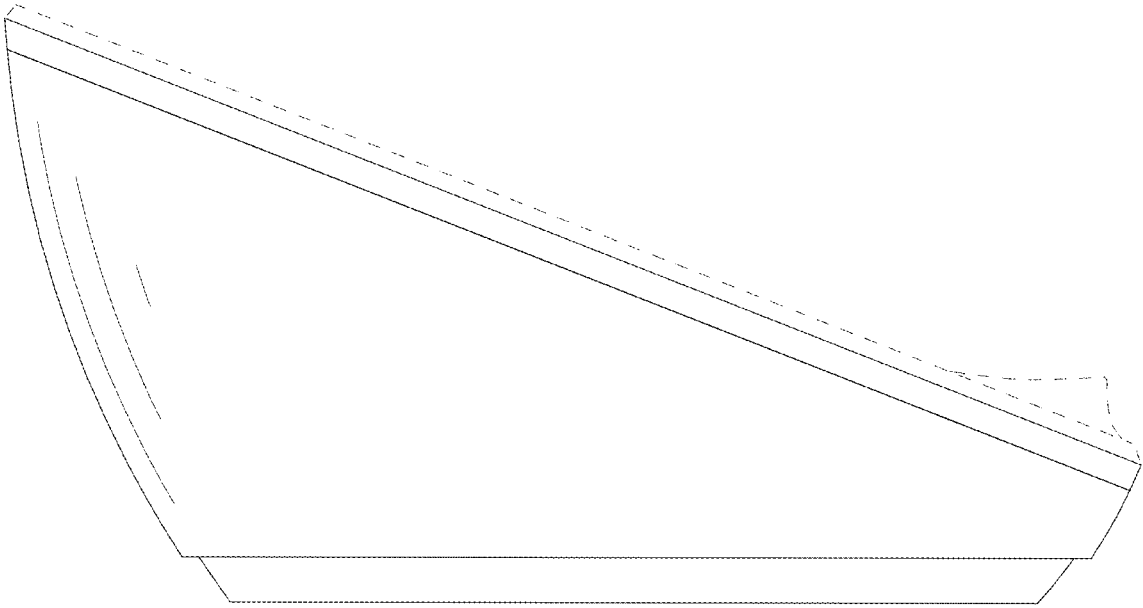

FIG. 13

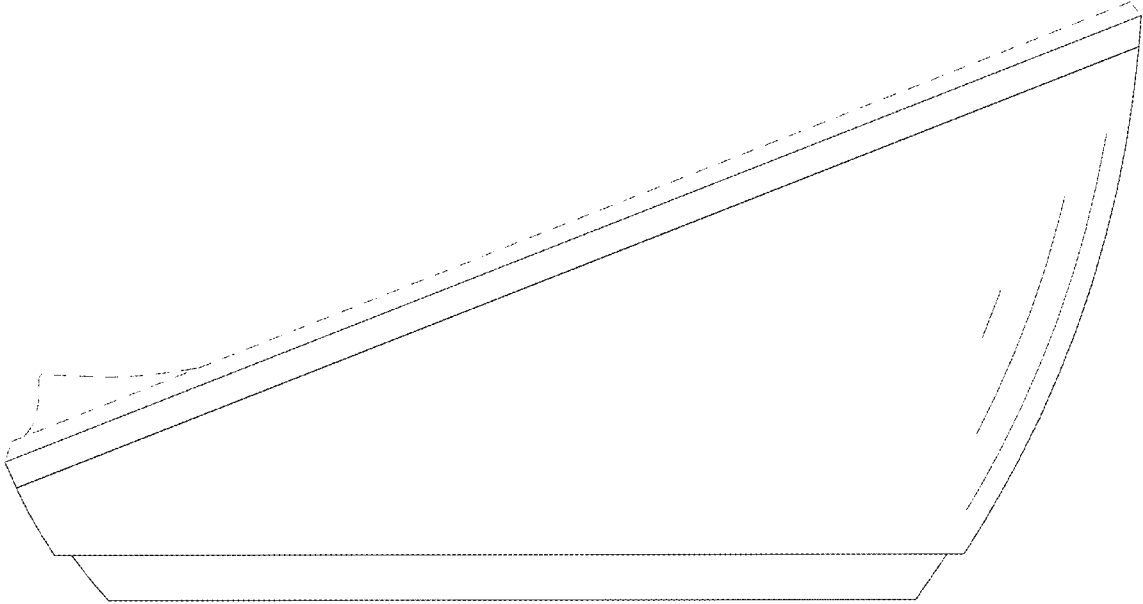

FIG. 14

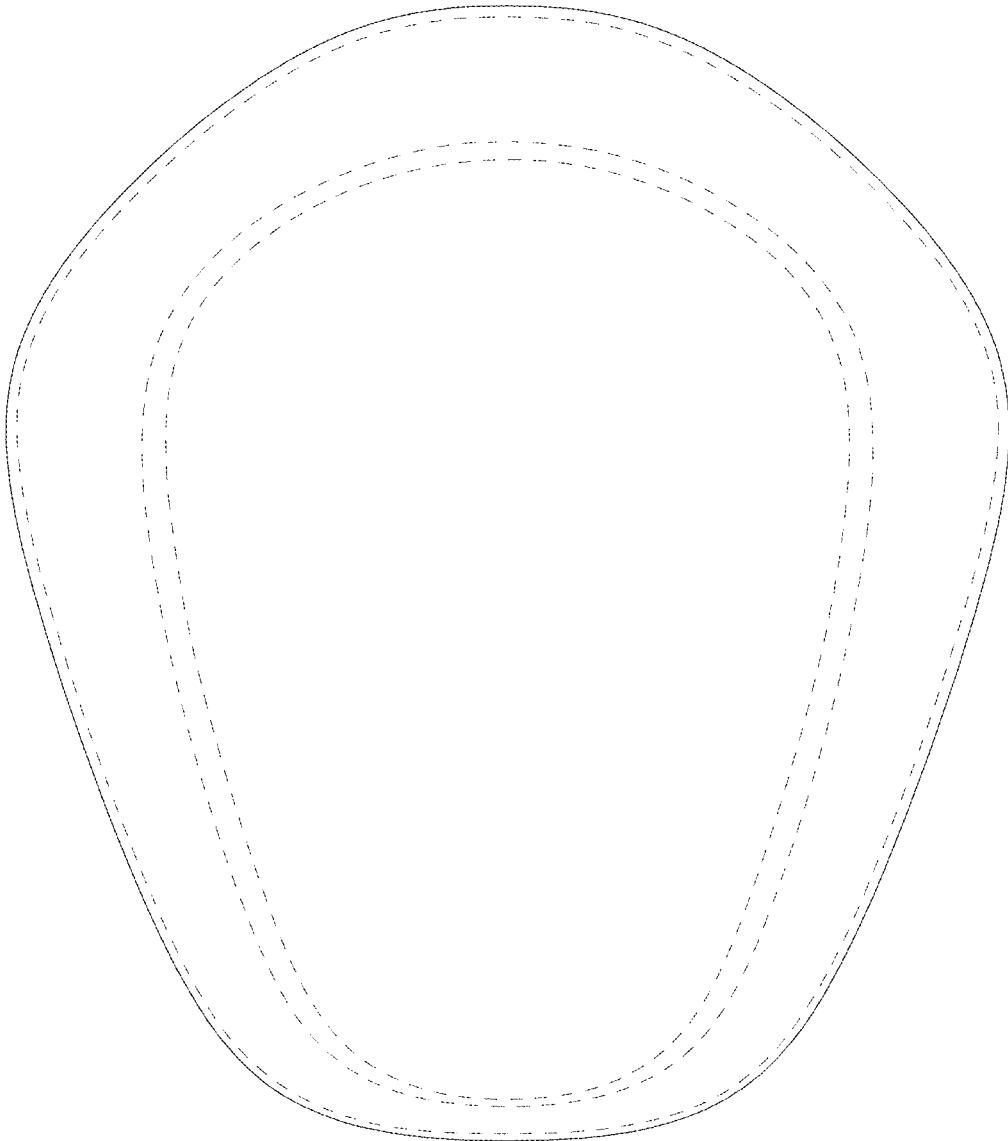

FIG. 15

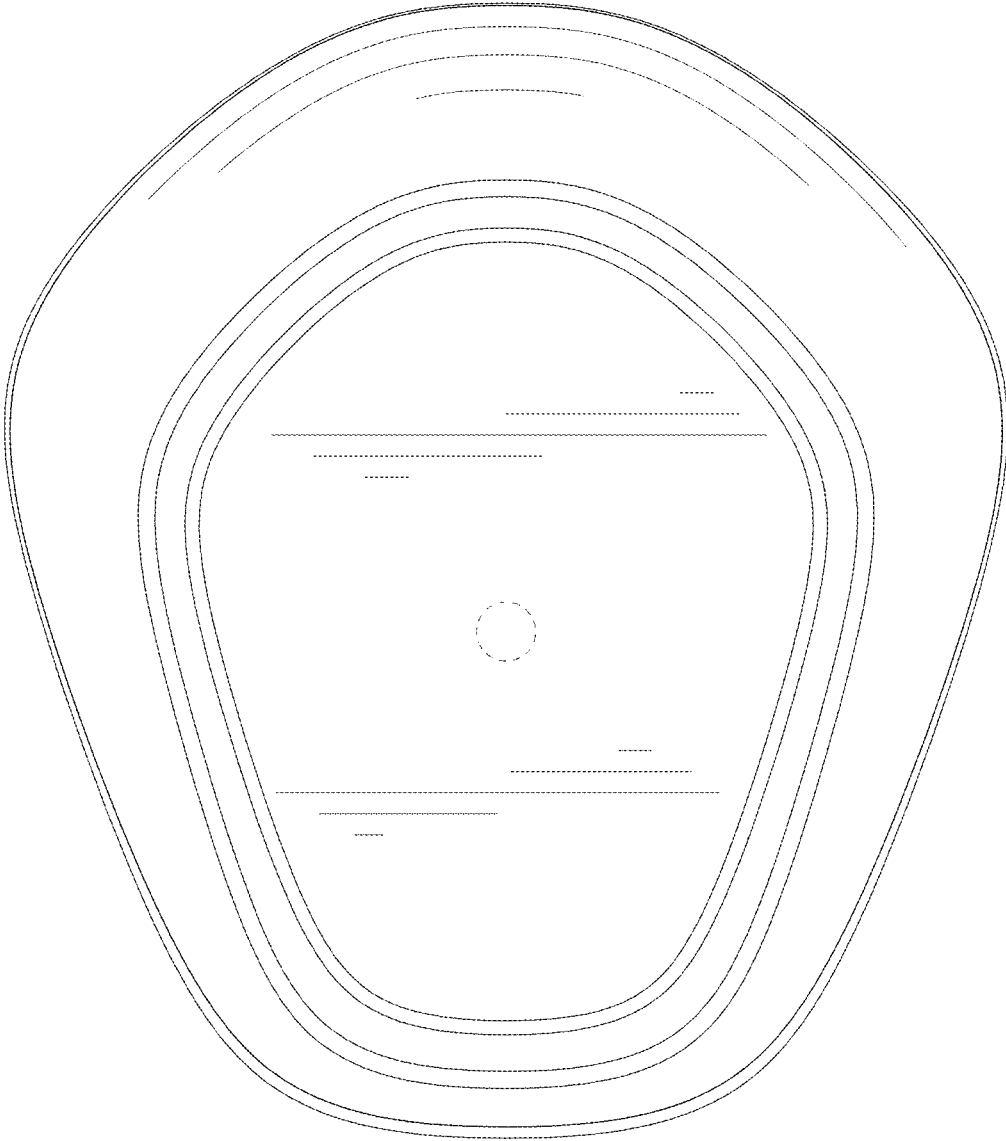

FIG. 16

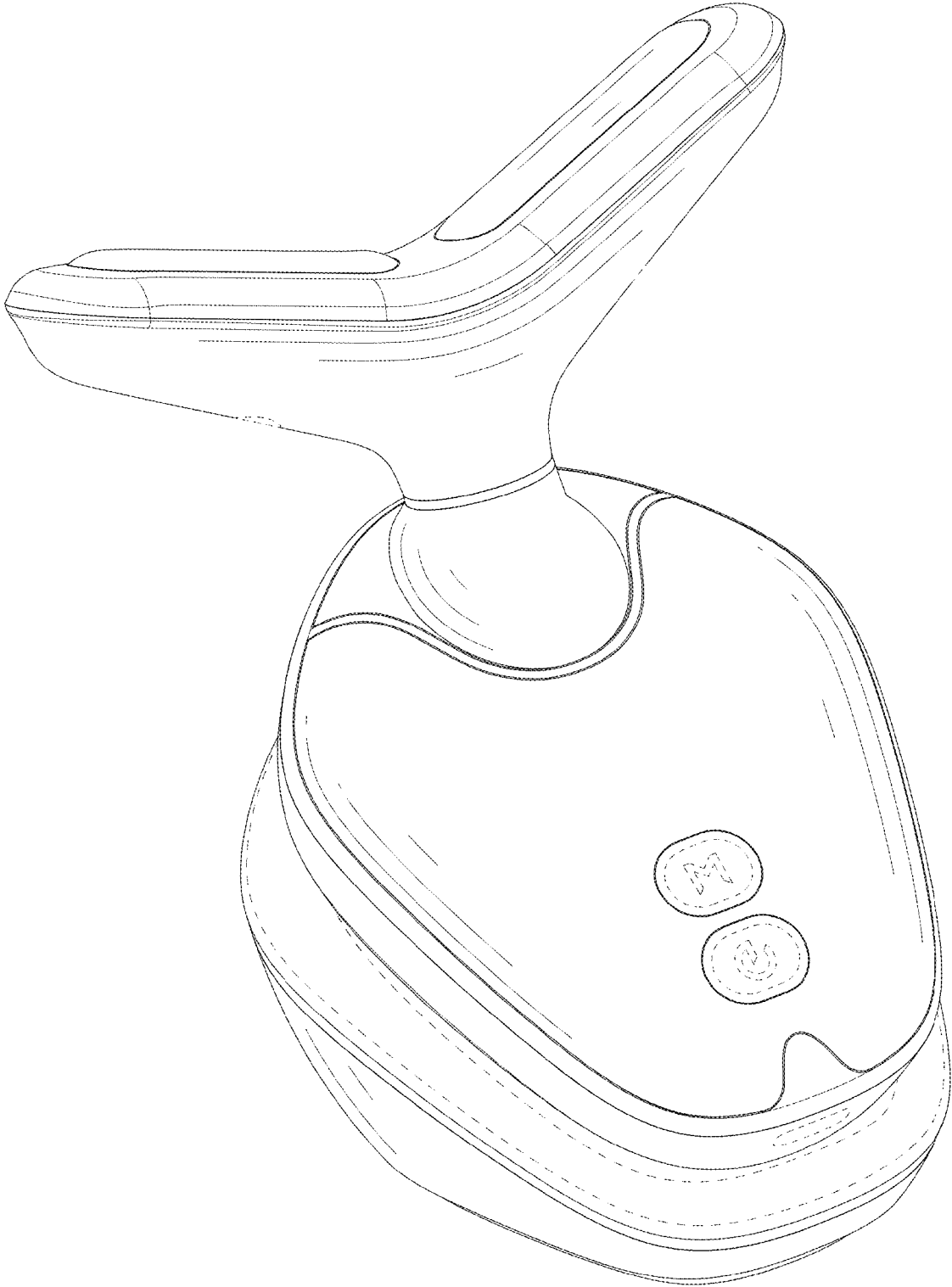

FIG. 17