



US00D366397S

United States Patent [19]
Zimmerman

[11] **Patent Number:** **Des. 366,397**
[45] **Date of Patent:** ****Jan. 23, 1996**

[54] **STORAGE CONTAINER**

4,819,824 4/1989 Longbottom et al. D7/629 X

[75] Inventor: **Larry G. Zimmerman**, Hollis, N.H.

Primary Examiner—Terry A. Wallace
Attorney, Agent, or Firm—Donald Brown

[73] Assignee: **Sterilite Corporation**, Townsend, Mass.

[57] **CLAIM**

[**] Term: **14 Years**

The ornamental design of a storage container, as shown and described.

[21] Appl. No.: **27,462**

[22] Filed: **Aug. 22, 1994**

DESCRIPTION

[52] **U.S. Cl.** **D7/629; D7/538**

FIG. 1 is an exploded perspective view of a storage container showing my new design;

[58] **Field of Search** **D7/629, 538-549;**
D9/414, 416, 424, 430-432, 434, 435, 438,
443; 220/270, 306, 307, 352

FIG. 2 is a top, front, right side perspective view thereof in a closed position;

FIG. 3 is a top plan view thereof;

FIG. 4 is a bottom plan view thereof;

FIG. 5 is a left side elevation view thereof;

FIG. 6 is a right side elevation view thereof;

FIG. 7 is a rear elevation view thereof; and,

FIG. 8 is a front elevation view thereof.

[56] **References Cited**

U.S. PATENT DOCUMENTS

- D. 238,148 12/1975 Magnus .
- D. 267,703 1/1983 Chase et al. .
- D. 277,632 2/1985 Staufenberg .
- D. 308,941 7/1990 Kong D7/541 X
- D. 316,513 4/1991 Wolff D9/424 X

1 Claim, 4 Drawing Sheets

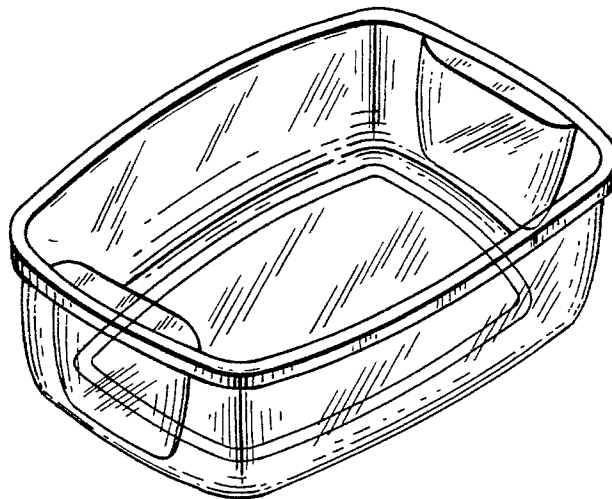
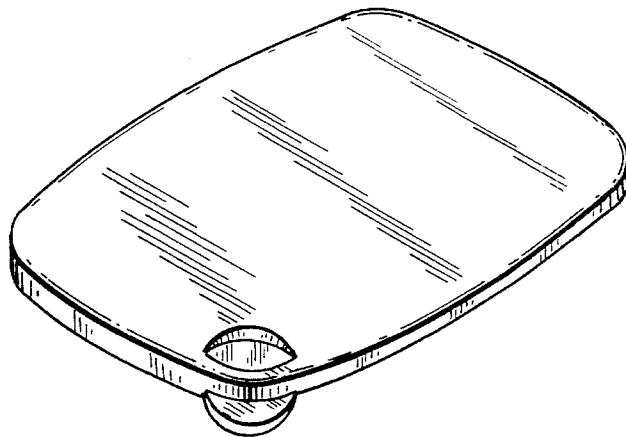

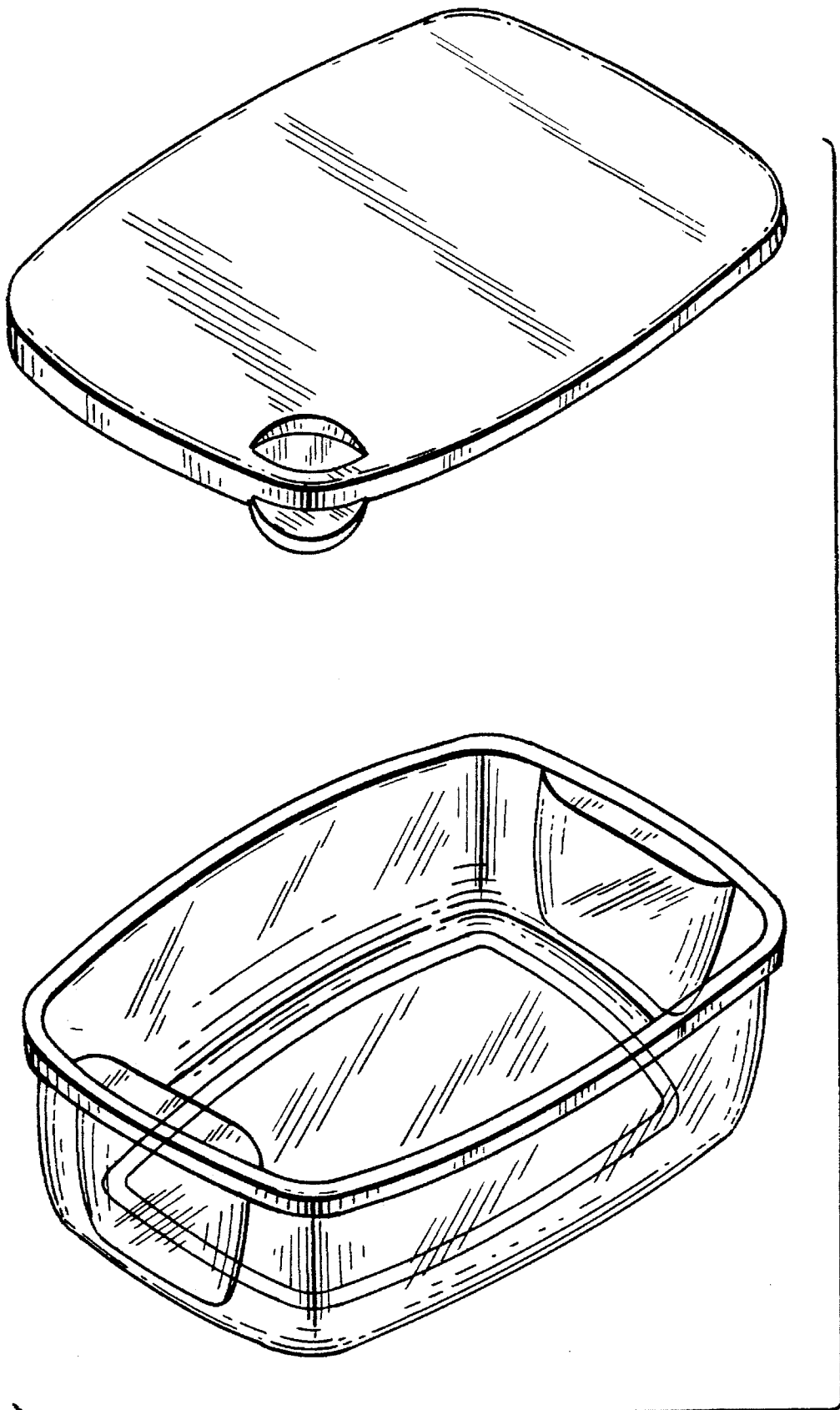

FIG. 1

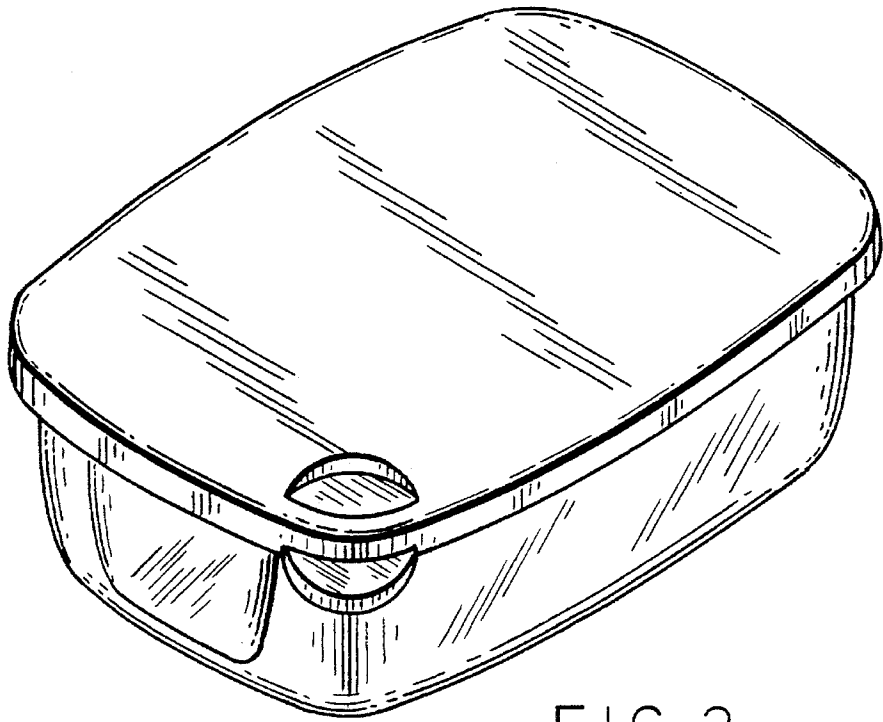

FIG. 2

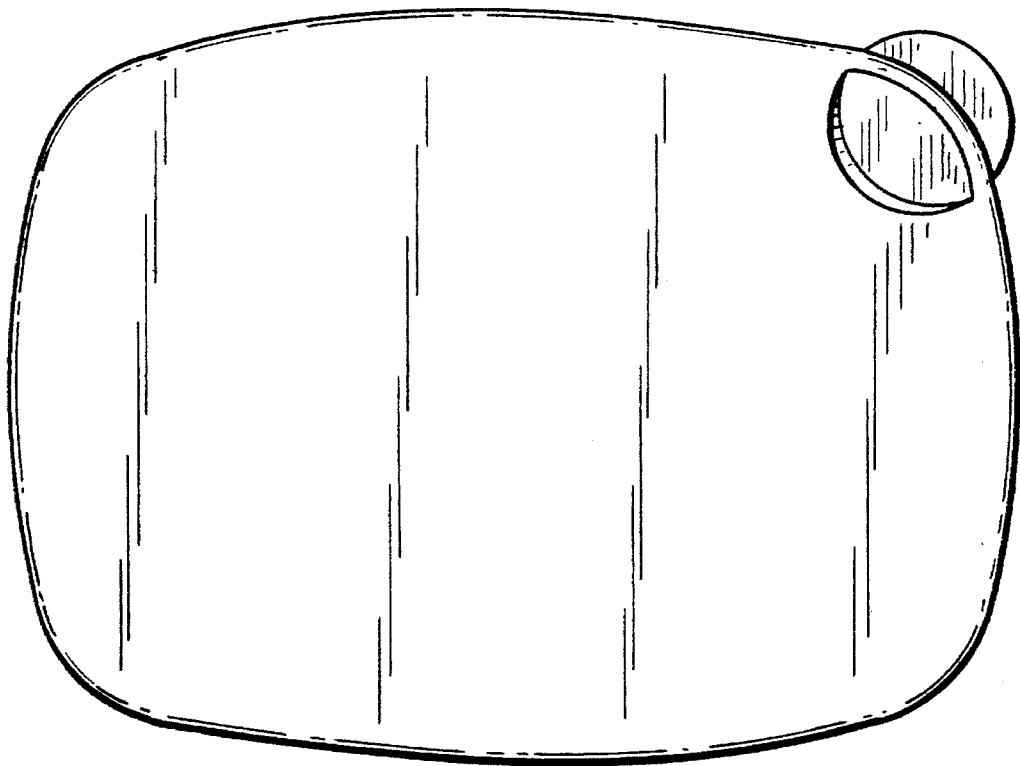

FIG. 3

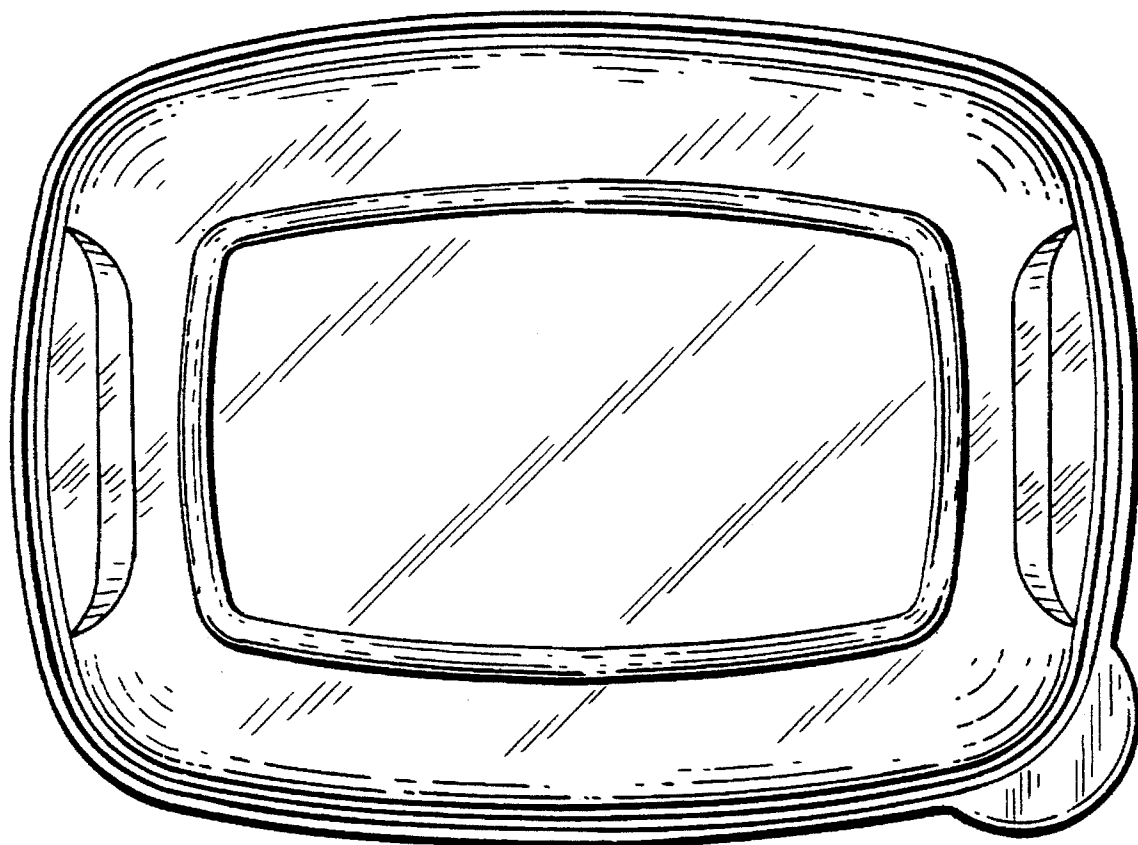

FIG. 4

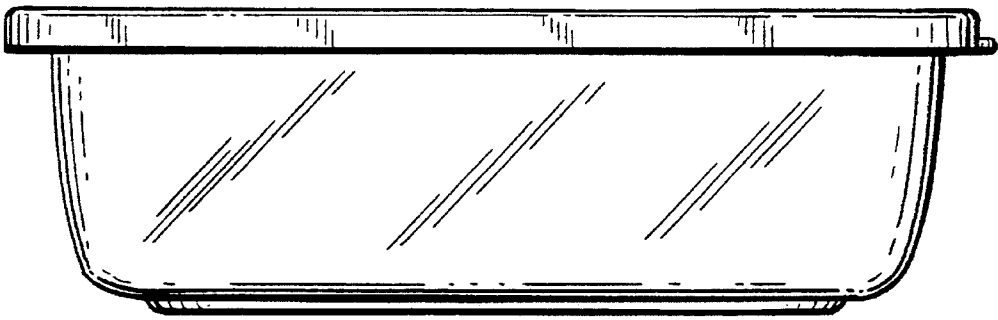

FIG. 5

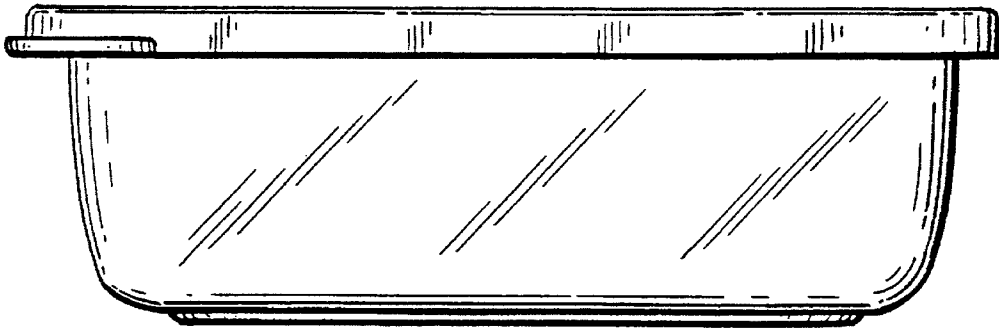

FIG. 6

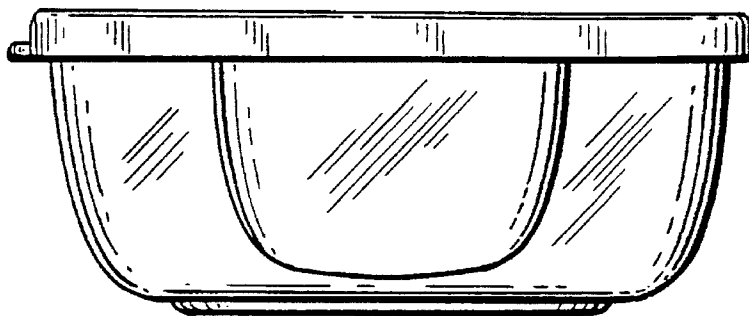

FIG. 7

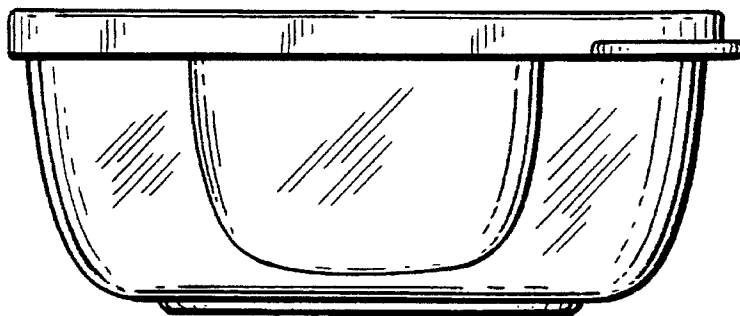

FIG. 8