

[54] CORDLESS COMBINATION HANDSET AND STAND TELEPHONE SET

[75] Inventor: James T. Asaki, Raleigh, N.C.

[73] Assignee: ITT Corporation, New York, N.Y.

[**] Term: 14 Years

[21] Appl. No.: 575,372

[22] Filed: Jan. 30, 1984

[52] U.S. Cl. D14/53; D14/62; D14/63; D14/58

[58] Field of Search D14/53, 58, 60, 62, D14/63, 64; 179/179, 100 R, 100 D, 100 C, 100 L, 101, 102, 103; D21/111

[56] References Cited

U.S. PATENT DOCUMENTS

D. 212,423	10/1968	Tyson et al.	D14/64
D. 265,734	8/1982	Mahan	D14/60
D. 277,574	2/1985	Lee	D14/64
D. 278,434	4/1985	Nestell	D14/60
D. 279,004	5/1985	Ryan	D14/63
D. 281,242	11/1985	Hova	D14/60
4,533,791	8/1985	Read et al.	179/2 R

OTHER PUBLICATIONS

1983-1984 Best Catalog, Uniden Model EX-3000, and "Cobra" Cordless Model CP1305 at p. 337.

B. A. Pamphlet ©1983; at p. 23 Teleconcepts-70-0®-Pulse; and Panasonic VA-7020, at p. 21; and Uniden Models on pp. 16-17.

Primary Examiner—James R. Largen

Assistant Examiner—Horace B. Fay

Attorney, Agent, or Firm—John T. O'Halloran; Thomas F. Meagher

[57] CLAIM

The ornamental design for a cordless combination handset and stand telephone set, as shown and described.

DESCRIPTION

FIG. 1 is a top plan view of a cordless combination handset and stand telephone set showing my new design;

FIG. 2 is a top plan view of the stand alone;

FIG. 3 is a left side elevational view of the stand;

FIG. 4 is a left side elevational view of the assembled set;

FIG. 5 is a right side elevational view of the stand;

FIG. 6 is a right side elevational view of the assembled set;

FIG. 7 is a rear end elevational view of the assembled set;

FIG. 8 is a rear end elevational view of the stand;

FIG. 9 is a front end elevational view of the assembled set;

FIG. 10 is a front end elevational view of the stand;

FIG. 11 is a bottom plan view of the handset;

FIG. 12 is a top plan view of the handset;

FIG. 13 is a right side elevational view of the handset;

FIG. 14 is a left side elevational view of the handset;

FIG. 15 is a rear end elevational view of the handset;

FIG. 16 is a front end elevational view of the handset; and

FIG. 17 is a perspective front, top and partial right side of the assembled set.

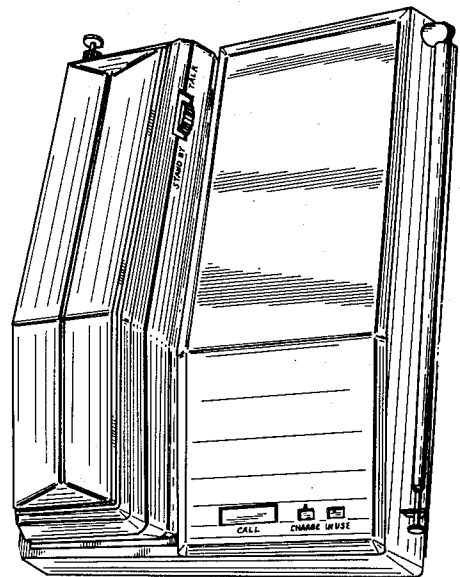
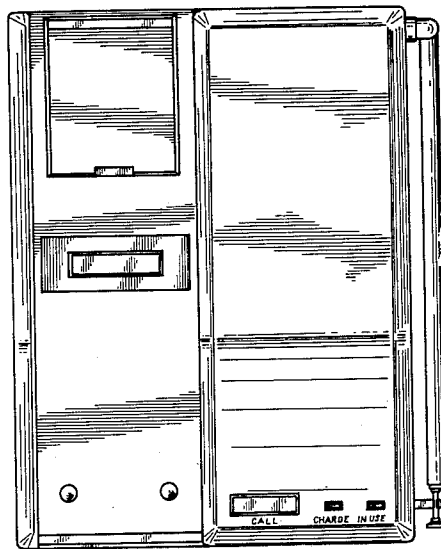
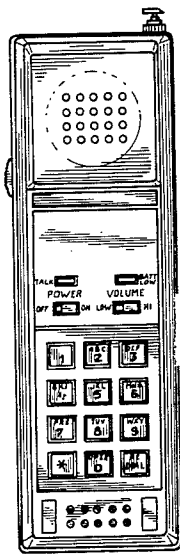

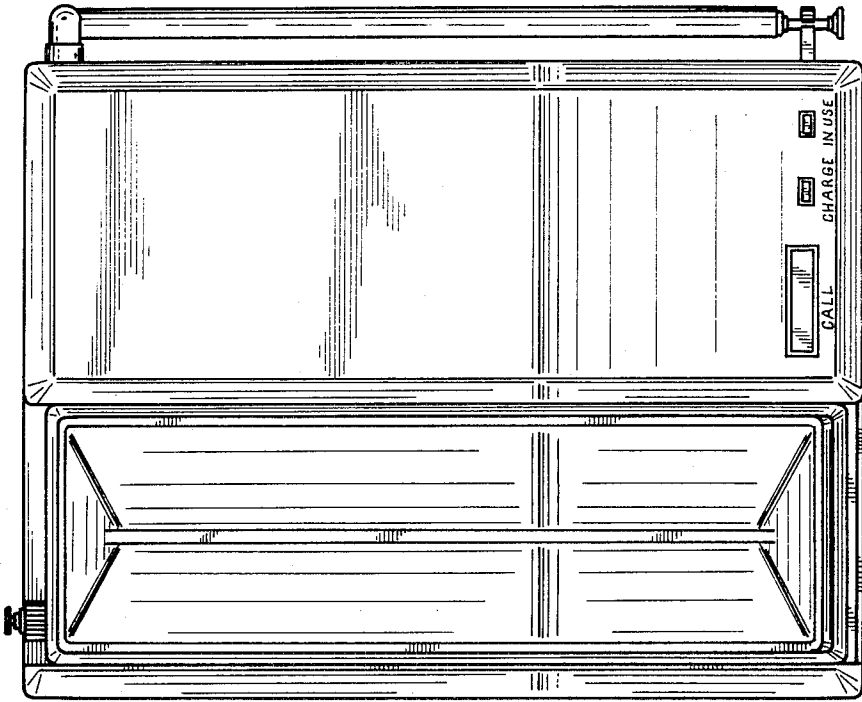

Fig. 2

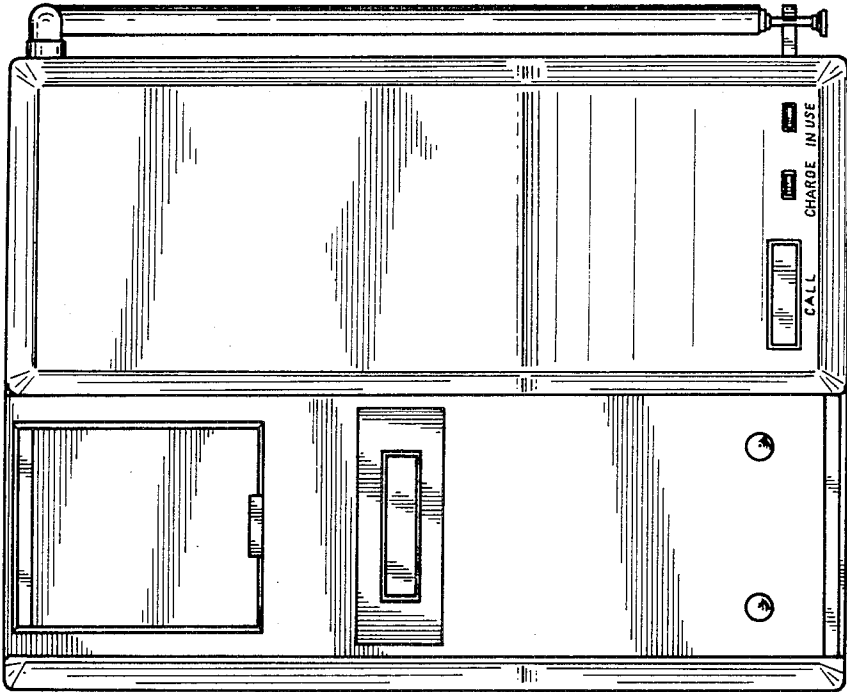

Fig. 1

Fig. 3

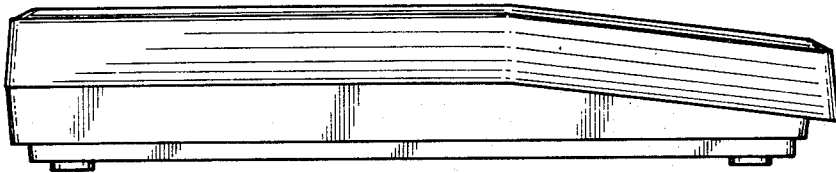

Fig. 4

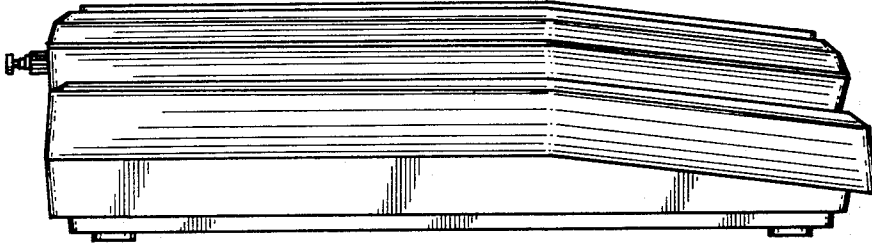

Fig. 5

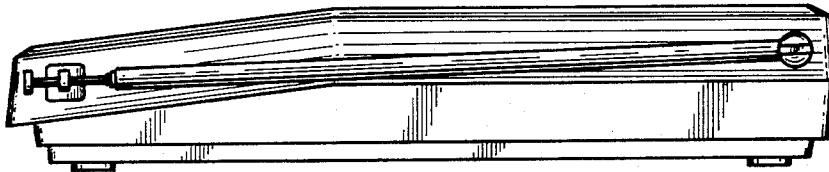

Fig. 6

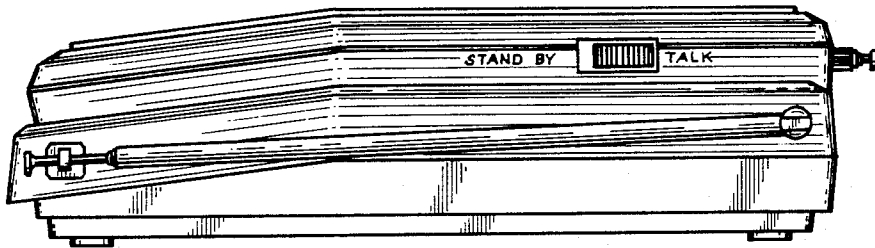

Fig. 7

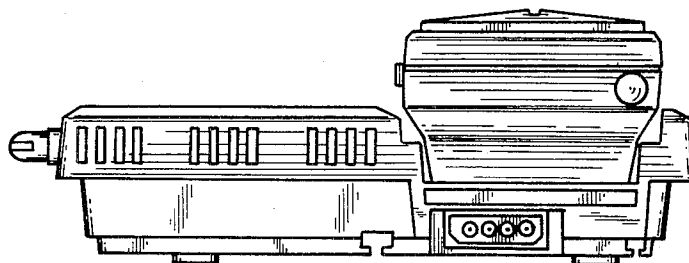

Fig. 8

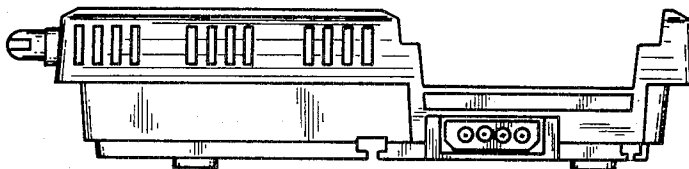

Fig. 9

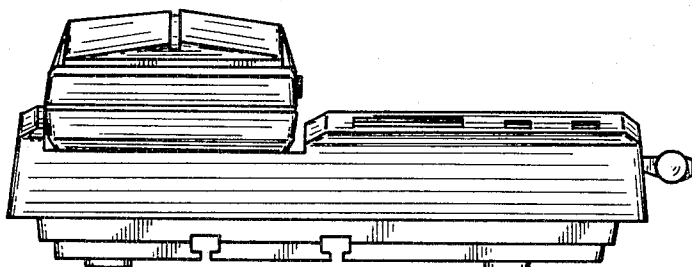
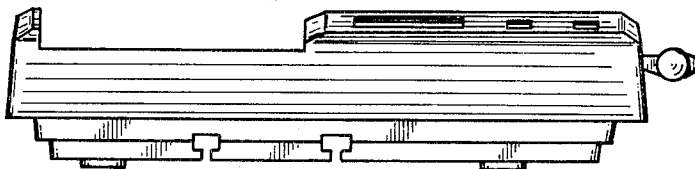

Fig. 10



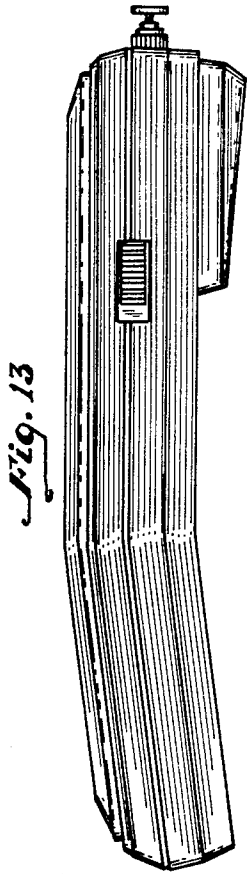

Fig. 13

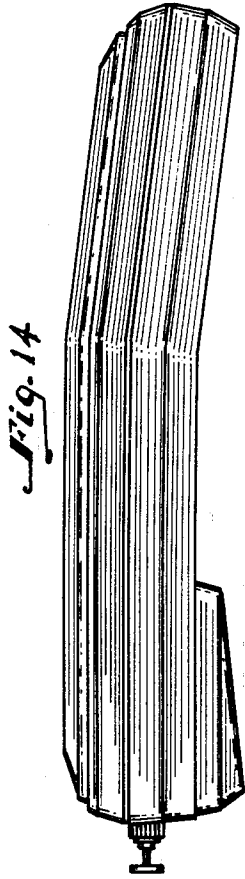

Fig. 14

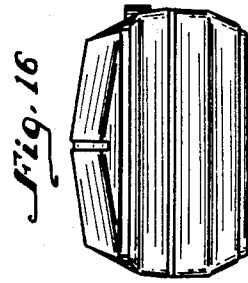

Fig. 16

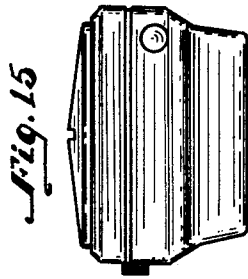

Fig. 15

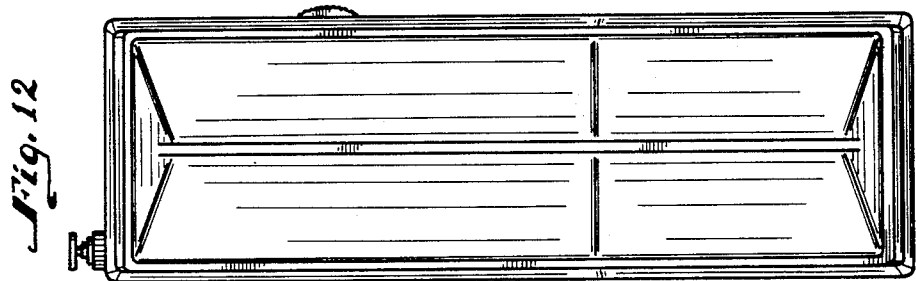

Fig. 12

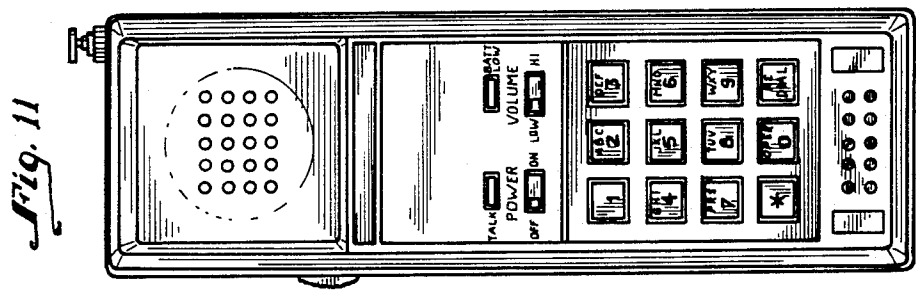

Fig. 11

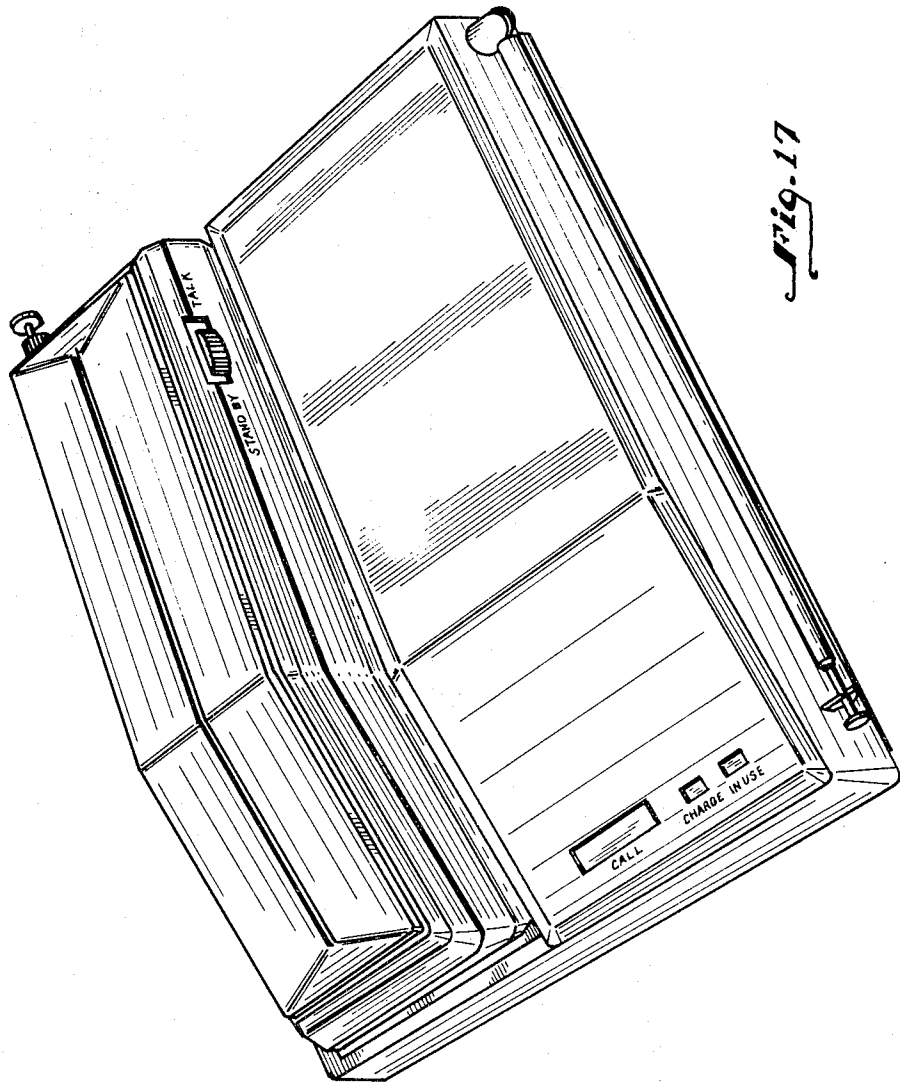

Fig. 17